

NJG1705V

■ABSOLUTE MAXIMUM RATINGS

($T_a=+25^{\circ}\text{C}$, $Z_s=Z_l=50\Omega$)

PARAMETER	SYMBOL	CONDITIONS	RATINGS	UNITS
LNA Voltage	V_{LNA}		5.0	V
MIXER Voltage	V_{MIX}		5.0	V
Local Amplifier Voltage	V_{LO}		5.0	V
InputPower1	P_{LNAIN}	$V_{LNA}=V_{MIX}=V_{LO}=2.7V$	+15	dBm
InputPower2	P_{LOIN}	$V_{LNA}=V_{MIX}=V_{LO}=2.7V$	+10	dBm
Power Dissipation	P_D		320	mW
Operating Temperature	T_{opr}		-40~+85	$^{\circ}\text{C}$
Storage Temperature	T_{stg}		-55~+125	$^{\circ}\text{C}$

■ELECTRICAL CHARACTERISTICS 1 (1.5GHz band)

COMMON CONDITIONS: $T_a=+25^{\circ}\text{C}$, $V_{LNA}=V_{MIX}=V_{LO}=2.7V$, $f_{RF}=1489\text{MHz}$, $f_{LO}=1619\text{MHz}$, $f_{IF}=130\text{MHz}$,
 $P_{RF}=-50\text{dBm}$, $P_{LO}=-10\text{dBm}$, $Z_s=Z_l=50\Omega$, Application Circuit,
 1.5GHz band, $f_{LO}=1619\text{MHz}$

PARAMETER	SYMBOL	CONDITIONS	MIN	TYP	MAX	UNITS
Operating Frequency	freq		1470	1489	1520	MHz
LNA Voltage	V_{LNA}		2.5	2.7	4.5	V
MIXER Voltage	V_{MIX}		2.5	2.7	4.5	V
Local Amplifier Voltage	V_{LO}		2.5	2.7	4.5	V
LNA current	I_{LNA}	RF, LO=OFF	-	3.5	5.0	mA
MIXER current	I_{MIX}	RF, LO=OFF	-	5.0	6.6	mA
Local Amplifier current	I_{LO}	RF, LO=OFF	-	1.0	2.0	mA
Total current	I_{AL}	RF, LO=OFF	-	9.5	13.6	mA
Conversion Gain	Gc		21.0	23.5	-	dB
Gain Flatness	G_{flat}	$f_{RF}=1470\text{-}1520\text{MHz}$	-	1.0	1.5	dB
Noise Figure	NF		-	1.6	1.9	dB
1dB Gain Compression Output Power	P-1dB		-4.0	-2.0	-	dBm
Input 3'rd Intercept Point	IIP3	$f_{RF}=1489.0+1489.1\text{MHz}$	-18.0	-15.5	-	dBm
Image Suppression Level	IMR		-	-11.0	-8.0	dBc
RF IN VSWR	VSWR _i		-	2.0	3.0	

■ ELECTRICAL CHARACTERISTICS (1.5GHz band LNA)

COMMON CONDITIONS: $T_a=+25^{\circ}\text{C}$, $V_{\text{LNA}}=2.7\text{V}$, $V_{\text{MIX}}=V_{\text{LO}}=0\text{V}$, $f_{\text{RF}}=1489\text{MHz}$, $Z_s=Z_l=50\Omega$,
 $f_{\text{LO}}=1619\text{MHz}$, Application Circuit, 1.5GHz band, $f_{\text{LO}}=1619\text{MHz}$

PARAMETER	SYMBOL	CONDITIONS	MIN	TYP	MAX	UNITS
Small Signal Gain	Gain		-	15.0	-	dB
Noise Figure	NF		-	1.2	-	dB
Input 3'rd Intercept Point	IIP3	$f_{\text{RF}}=1489.0+1489.1\text{MHz}$	-	-4.0	-	dBm
RF IN VSWR	VSWR _i		-	2.0	-	
RF OUT VSWR	VSWR _o		-	2.0	-	

■ ELECTRICAL CHARACTERISTICS (1.5GHz band MIXER)

COMMON CONDITIONS: $T_a=+25^{\circ}\text{C}$, $V_{\text{LNA}}=0\text{V}$, $V_{\text{MIX}}=V_{\text{LO}}=2.7\text{V}$, $f_{\text{RF}}=1489\text{MHz}$, $f_{\text{LO}}=1619\text{MHz}$,
 $P_{\text{RF}}=-30\text{dBm}$, $P_{\text{LO}}=-10\text{dBm}$, $Z_s=Z_l=50\Omega$, Application Circuit,
 1.5GHz band, $f_{\text{LO}}=1619\text{MHz}$

PARAMETER	SYMBOL	CONDITIONS	MIN	TYP	MAX	UNITS
Conversion Gain	G_c		-	8.0	-	dB
Noise Figure	NF		-	8.0	-	dB
Input 3'rd Intercept Point	IIP3	$f_{\text{RF}}=1489.0+1489.1\text{MHz}$	-	-1.0	-	dBm

NJG1705V

■ELECTRICAL CHARACTERISTICS 2 (1.9GHz band)

COMMON CONDITIONS: $T_a=+25^{\circ}\text{C}$, $V_{\text{LNA}}=V_{\text{MIX}}=V_{\text{LO}}=2.7\text{V}$, $f_{\text{RF}}=1900\text{MHz}$, $f_{\text{LO}}=1660\text{MHz}$, $f_{\text{IF}}=240\text{MHz}$,
 $P_{\text{RF}}=-50\text{dBm}$, $P_{\text{LO}}=-10\text{dBm}$, $Z_s=Z_l=50\Omega$, Application Circuit,
 1.9GHz band, $f_{\text{LO}}=1660\text{MHz}$

PARAMETER	SYMBOL	CONDITIONS	MIN	TYP	MAX	UNITS
Operating Frequency	freq		1890	1900	1920	MHz
LNA Voltage	V_{LNA}		2.5	2.7	4.5	V
MIXER Voltage	V_{MIX}		2.5	2.7	4.5	V
Local Amplifier Voltage	V_{LO}		2.5	2.7	4.5	V
LNA Current *1	I_{LNA}	RF, LO=OFF	-	3.5	5.0	mA
MIXER Current *2	I_{MIX}	RF, LO=OFF	-	5.0	6.6	mA
Local Amplifier Current *3	I_{LO}	RF, LO=OFF	-	1.0	2.0	mA
Total Current	I_{AL}	RF, LO=OFF	-	9.5	13.6	mA
Conversion Gain	Gc		18.5	20.5	-	dB
Gain Flatness	G_{flat}	$f_{\text{RF}}=1890\text{-}1920\text{MHz}$	-	1.3	1.8	dB
Noise Figure	NF		-	2.2	2.5	dB
1dB Gain Output Compression Output Power	P-1dB		-3.0	-1.0	-	dBm
Input 3'rd Intercept Point	IIP3	$f_{\text{RF}}=1900.0+1900.1\text{MHz}$	-14.0	-10.0	-	dBm
Image Suppression Level	IMR		-	-6.5	-4.5	dBc
RF IN VSWR	VSWR _I		-	2.0	3.0	

■ELECTRICAL CHARACTERISTICS (1.9GHz band LNA)

COMMON CONDITIONS: $T_a=+25^{\circ}\text{C}$, $V_{\text{LNA}}=2.7\text{V}$, $V_{\text{MIX}}=V_{\text{LO}}=0\text{V}$, $f_{\text{RF}}=1900\text{MHz}$, $Z_s=Z_l=50\Omega$,
Application Circuit, 1.9GHz band, $f_{\text{LO}}=1660\text{MHz}$

PARAMETER	SYMBOL	CONDITIONS	MIN	TYP	MAX	UNITS
Small signal Gain	Gain		-	13.0	-	dB
Noise Figure	NF		-	1.4	-	dB
Input 3'rd Intercept Point	IIP3	$f_{\text{RF}}=1900.0+1900.1\text{MHz}$	-	-3.0	-	dBm
RF IN VSWR	VSWRi		-	2.0	-	
RF OUT VSWR	VSWRo		-	2.0	-	

■ELECTRICAL CHARACTERISTICS (1.9GHz band MIXER)

COMMON CONDITIONS: $T_a=+25^{\circ}\text{C}$, $V_{\text{LNA}}=0\text{V}$, $V_{\text{MIX}}=V_{\text{LO}}=2.7\text{V}$, $f_{\text{RF}}=1900\text{MHz}$, $f_{\text{LO}}=1660\text{MHz}$,
 $P_{\text{RF}}=-30\text{dBm}$, $P_{\text{LO}}=-10\text{dBm}$, $Z_s=Z_l=50\Omega$, $f_{\text{LO}}=1660\text{MHz}$,
Application Circuit, 1.9GHz band, $f_{\text{LO}}=1660\text{MHz}$

PARAMETER	SYMBOL	CONDITIONS	MIN	TYP	MAX	UNITS
Conversion Gain	G_c		-	8.0	-	dB
Noise Figure	NF		-	8.0	-	dB
Input 3'rd Intercept Point	IIP3	$f_{\text{RF}}=1900.0+1900.1\text{MHz}$	-	4.0	-	dBm

■ TERMINAL INFORMATION

No.	SYMBOL	DESCRIPTIONS
1	LNAIN	RF input terminal of LNA. The RF signal is input through external matching circuit.
2	LNACAP	Terminal for the bypass capacitor of LNA. The bypass capacitor C1 shown in application circuit, should be connected to this terminal as close as possible.
3	GND	Ground terminal(0V)
4	IFOUT	IF signal output terminal. The IF signal is output though external matching circuit's connected to this terminal. Please connect inductance L8 and power supply as application circuit since it is also the terminal of Mixer power supply.
5	VLO	Power supply terminal for local amplifier. Please connect R1 and L10 to this terminal shown in the application circuit as close as possible.
6	LOIN	Local signal input terminal of local amplifier. The local signal is terminal to local amplifier through external matching circuit.
7	GND	Ground terminal(0V)
8	MIXIN	RF signal input terminal of Mixer. The RF signal from LNA is sent to Mixer through matching circuit.
9	GND	Ground terminal(0V)
10	LNAOUT	Signal output terminal of LNA. The RF signal from LNA is output through external matching circuit connected to this terminal. Please connect inductance L4 and power supply shown in application circuit, since it is also the terminal of LNA power supply.

CAUTION

- 1) Ground terminal (No.3, 7, 9) should be connected to the ground plane as short as possible.

■ TYPICAL CHARACTERISTICS (LNA+MIXER 1.5GHz band $f_{LO}=1619\text{MHz}$)

Conversion Gain , Noise Figure vs. RF Frequency

($V_{LNA}=V_{MIX}=V_{LO}=2.7\text{V}$)

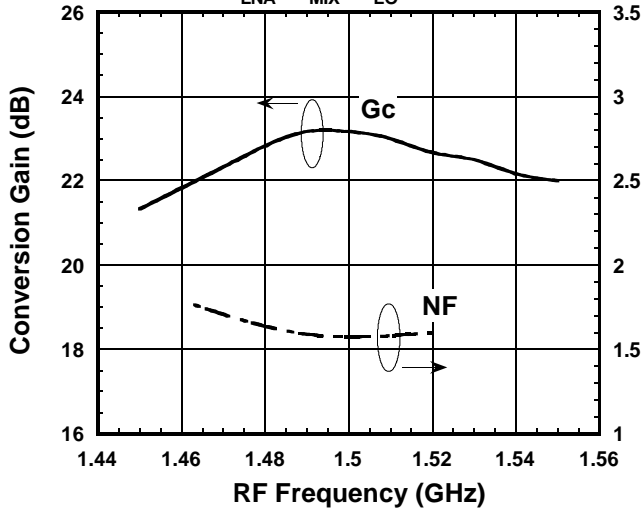

Condition
 $f_{IF}=130\text{MHz}$
 $P_{RF}=-50\text{dBm}$
 $P_{LO}=-10\text{dBm}$
 $V_{LNA}=V_{MIX}=V_{LO}=2.7\text{V}$
 Upper LOCAL

Conversion Gain , Noise Figure vs. LO Power

($V_{LNA}=V_{MIX}=V_{LO}=2.7\text{V}, f_{RF}=1489\text{MHz}, f_{LO}=1619\text{MHz}$)

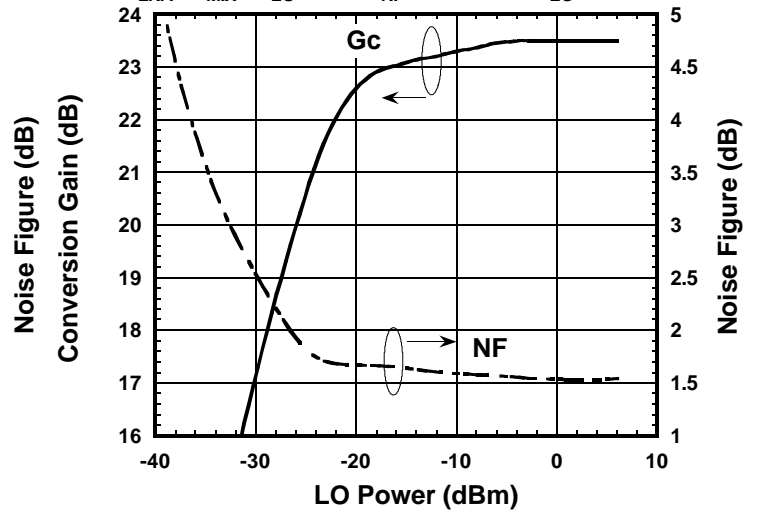

Condition
 $f_{IF}=130\text{MHz}$
 $f_{RF}=1489\text{MHz}, P_{RF}=-50\text{dBm}$
 $f_{LO}=1619\text{MHz}$
 $V_{LNA}=V_{MIX}=V_{LO}=2.7\text{V}$

Output-IP3 , Input-IP3 vs. LO Power

($V_{LNA}=V_{MIX}=V_{LO}=2.7\text{V}, f_{RF}=1469+1489.1\text{MHz}, f_{LO}=1619\text{MHz}$)

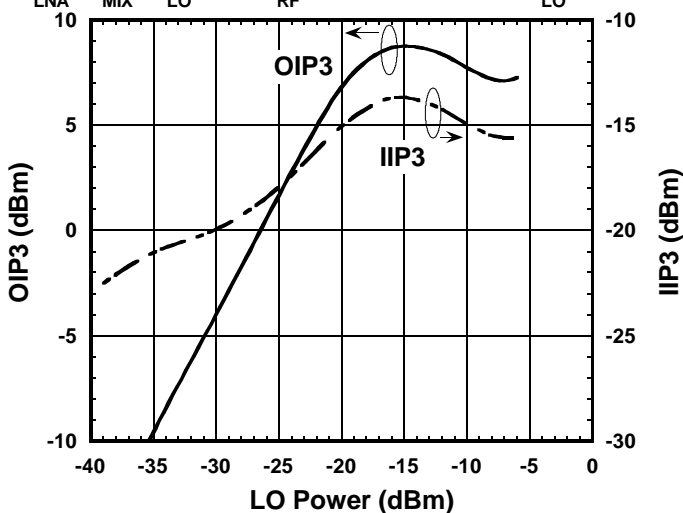

Condition
 $f_{IF}=130\text{MHz}$
 $f_{RF1}=1489.0\text{MHz}, P_{RF}=-35\text{dBm}$
 $f_{RF2}=1489.1\text{MHz}$
 $f_{LO}=1619\text{MHz}$
 $V_{LNA}=V_{MIX}=V_{LO}=2.7\text{V}$

$$OIP3 = \frac{3IF-IM3}{2}$$

$$IIP3 = \frac{3IF-IM3}{2} - G_c$$

@ $P_{RF}=-35\text{dBm}$

■ TYPICAL CHARACTERISTICS (LNA+MIXER 1.5GHz band $f_{LO}=1619\text{MHz}$)

RF IN IMPEDANCE

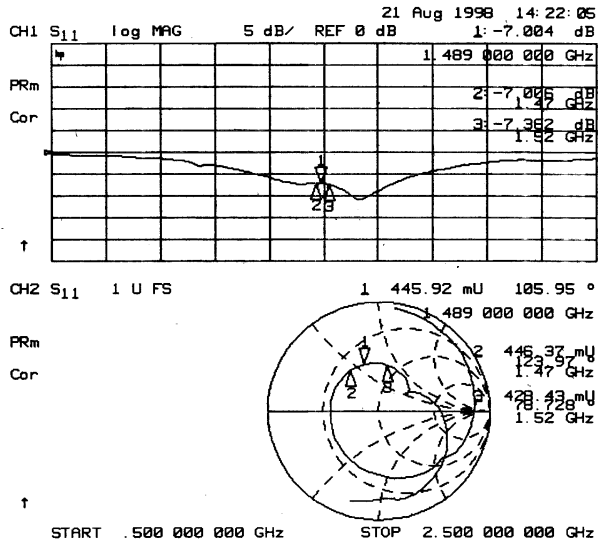

Condition
 $V_{LNA}=2.7\text{V}$
 $V_{MIX}=V_{LO}=2.7\text{V}$

LOCAL IN IMPEDANCE

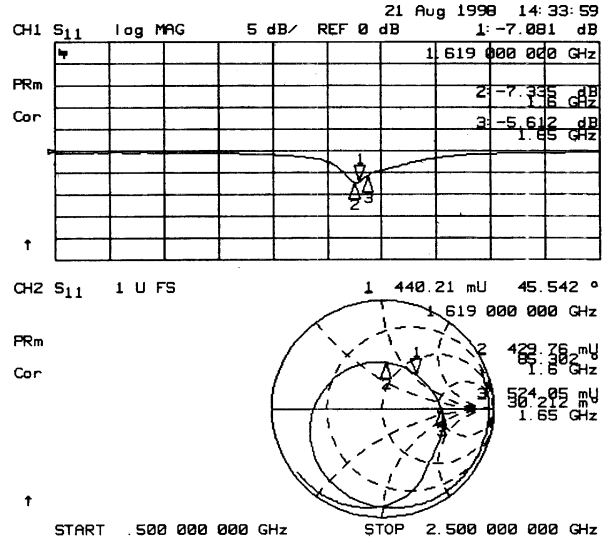

Condition
 $V_{LNA}=2.7\text{V}$
 $V_{MIX}=V_{LO}=2.7\text{V}$

IF OUT IMPEDANCE

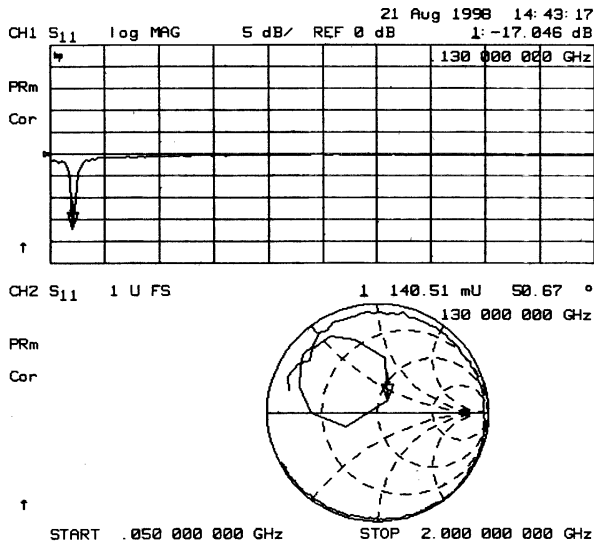

Condition
 $V_{LNA}=2.7\text{V}$
 $V_{MIX}=V_{LO}=2.7\text{V}$

■ TYPICAL CHARACTERISTICS (LNA+MIXER 1.5GHz band $f_{LO}=1619\text{MHz}$)

Conversion Gain , Noise Figure

vs. V_{LNA}, V_{MIX}, V_{LO}
 ($f_{RF}=1489\text{MHz}, f_{LO}=1619\text{MHz}$)

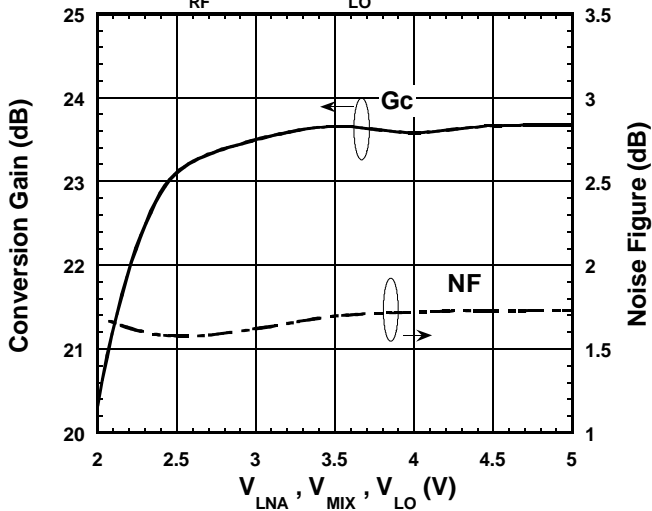

Condition
 $f_{IF}=130\text{MHz}$
 $f_{RF1}=1489\text{MHz}, P_{RF}=-50\text{dBm}$
 $f_{LO}=1619\text{MHz}, P_{LO}=-10\text{dBm}$

Output-IP3 , Input-IP3 vs. V_{LNA}, V_{MIX}, V_{LO}

($f_{RF}=1489+1489.1\text{MHz}, f_{LO}=1619\text{MHz}$)

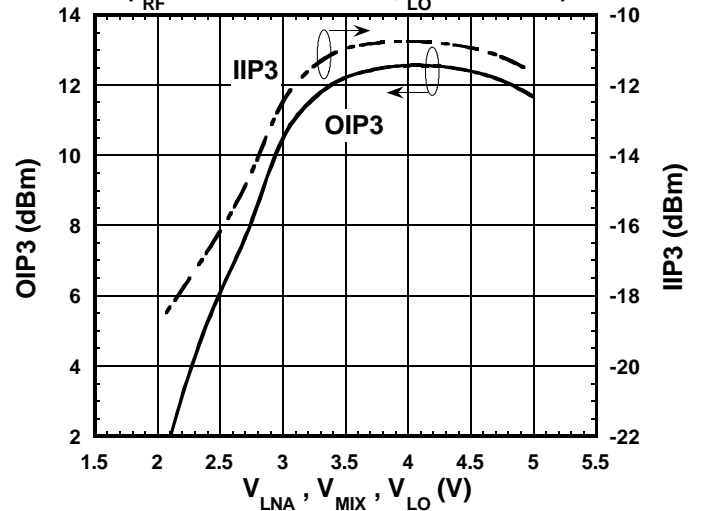

Condition
 $f_{IF}=130\text{MHz}$
 $f_{RF1}=1489.0\text{MHz}, P_{RF}=-35\text{dBm}$
 $f_{RF2}=1489.1\text{MHz}$
 $f_{LO}=1619\text{MHz}, P_{LO}=-10\text{dBm}$

$$OIP3 = \frac{3IF-IM3}{2}$$

$$IIP3 = \frac{3IF-IM3}{2} - G_c$$

@ $P_{RF}=-35\text{dBm}$

IF , IM3 vs. RF Power

($V_{LNA}=V_{MIX}=V_{LO}=2.7\text{V}, f_{RF}=1489+1489.1\text{MHz}, f_{LO}=1619\text{MHz}$)

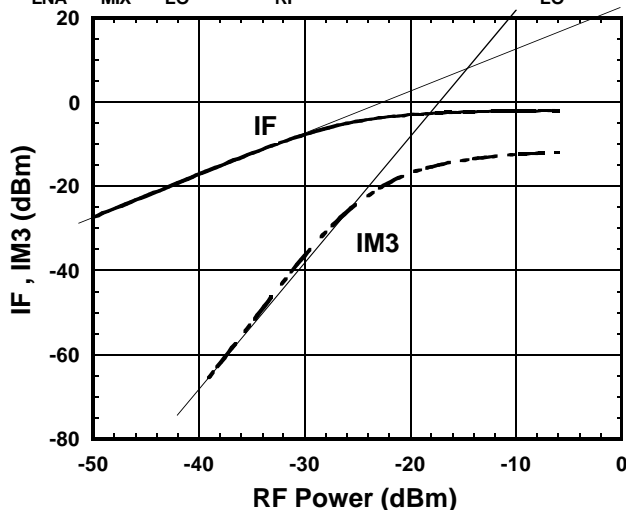

Condition
 $f_{IF}=130\text{MHz}$
 $f_{RF1}=1489.0\text{MHz}$
 $f_{RF2}=1489.1\text{MHz}$
 $f_{LO}=1619\text{MHz}, P_{LO}=-10\text{dBm}$
 $V_{LNA}=V_{MIX}=V_{LO}=2.7\text{V}$

IF vs. RF Power

($V_{LNA}=V_{MIX}=V_{LO}=2.7\text{V}, f_{RF}=1489\text{MHz}, f_{LO}=1619\text{MHz}$)

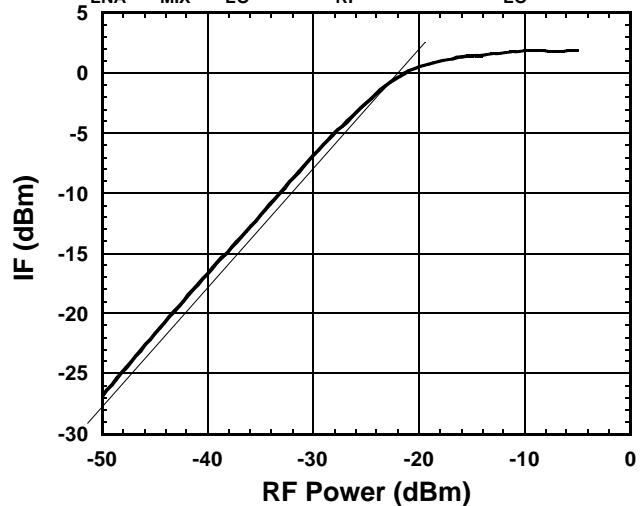

Condition
 $f_{IF}=130\text{MHz}$
 $f_{RF}=1489\text{MHz}$
 $f_{LO}=1619\text{MHz}, P_{LO}=-10\text{dBm}$
 $V_{LNA}=V_{MIX}=V_{LO}=2.7\text{V}$

■ TYPICAL CHARACTERISTICS (LNA+MIXER 1.5GHz band $f_{LO}=1619\text{MHz}$)

Conversion Gain , Noise Figure vs. Temperature

($V_{LNA}=V_{MIX}=V_{LO}=2.7\text{V}, f_{RF}=1489\text{MHz}, f_{LO}=1619\text{MHz}$)

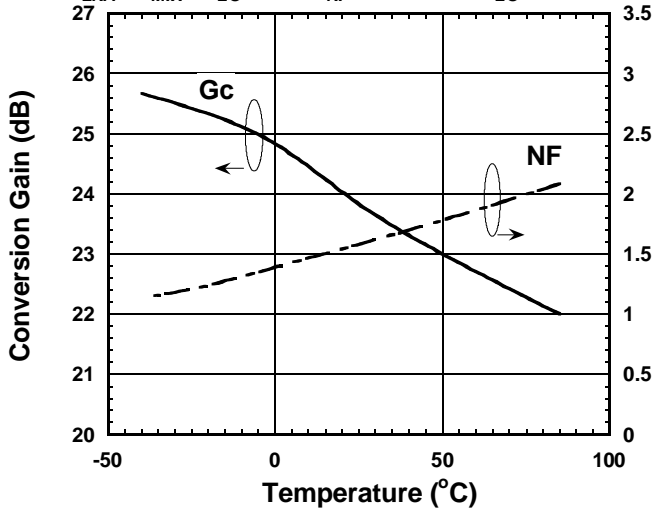

Condition
 $f_{IF}=130\text{MHz}$
 $f_{RF}=1489\text{MHz}, P_{RF}=-50\text{dBm}$
 $f_{LO}=1619\text{MHz}, P_{LO}=-10\text{dBm}$
 $V_{LNA}=V_{MIX}=V_{LO}=2.7\text{V}$

Output-IP3 , Input-IP3 vs. Temperature

($V_{LNA}=V_{MIX}=V_{LO}=2.7\text{V}, f_{RF}=1489\text{MHz}, f_{LO}=1619\text{MHz}$)

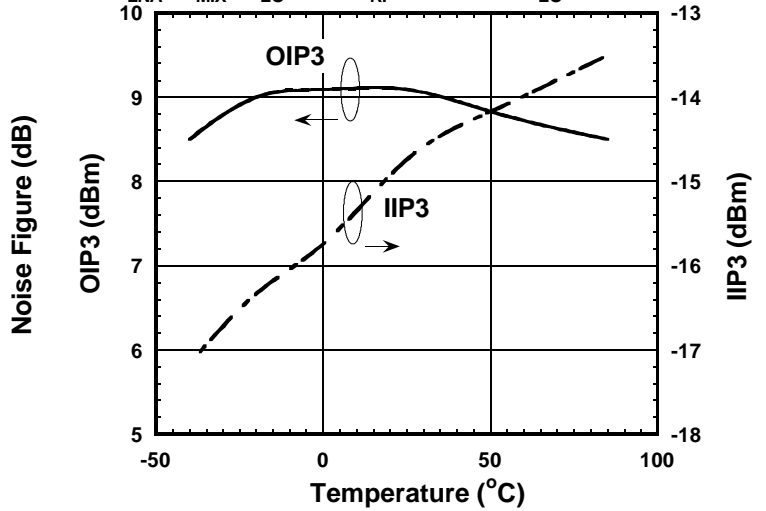

Condition
 $f_{IF}=130\text{MHz}$
 $f_{RF1}=1489.0\text{MHz}, P_{RF}=-35\text{dBm}$
 $f_{RF2}=1489.1\text{MHz}$
 $f_{LO}=1619\text{MHz}$
 $V_{LNA}=V_{MIX}=V_{LO}=2.7\text{V}$

$$OIP3 = \frac{3IF-IM3}{2}$$

$$IIP3 = \frac{3IF-IM3}{2} - G_c$$

@ $P_{RF}=-35\text{dBm}$

I_{LNA}, I_{MIX}, I_{LO} vs. Ambient Temperature

($V_{LNA}=V_{MIX}=V_{LO}=2.7\text{V}$)

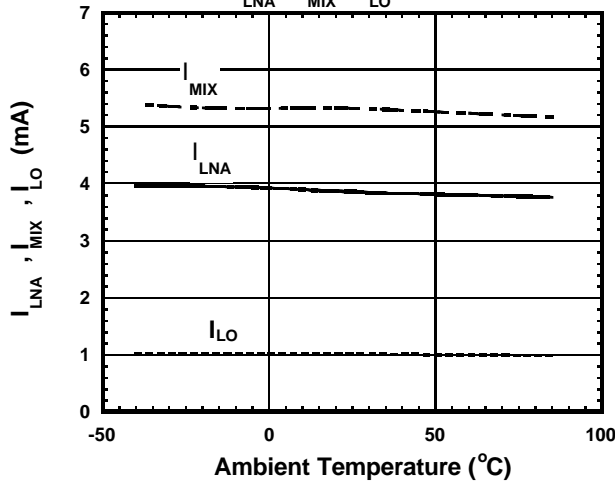

Condition
 $P_{RF}=\text{OFF}$
 $P_{LO}=\text{OFF}$
 $V_{LNA}=V_{MIX}=V_{LO}=2.7\text{V}$

■ TYPICAL CHARACTERISTICS (LNA+MIXER 1.5GHz band $f_{LO}=1619\text{MHz}$)

RF IN-LOCAL IN Isolation

($V_{LNA}=2.7\text{V}$)

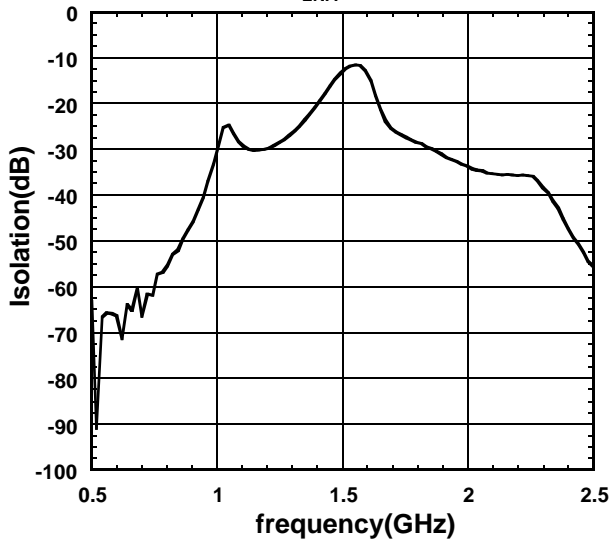

Condition
 $V_{LNA}=2.7\text{V}$
 $V_{MIX}=V_{LO}=2.7\text{V}$
 Port1: RF IN
 Port2: LOCAL IN

RF OUT-MIXER IN Isolation

($V_{LNA}=2.7\text{V}$)

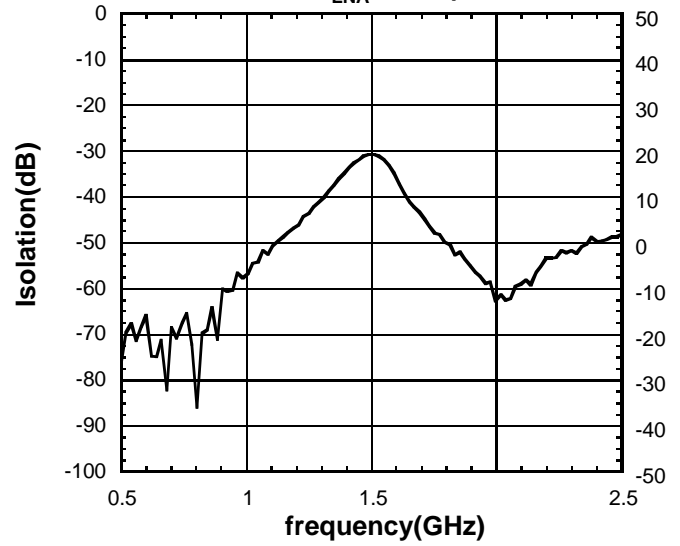

Condition
 $V_{LNA}=2.7\text{V}$
 $V_{MIX}=V_{LO}=2.7\text{V}$
 Port1: RF OUT
 Port2: MIXER IN

NJG1705V

■ TYPICAL CHARACTERISTICS (LNA 1.5GHz band $f_{LO}=1619\text{MHz}$)

S11,S21,S12,S22 Vs. frequency

($V_{LNA}=2.7\text{V}$)

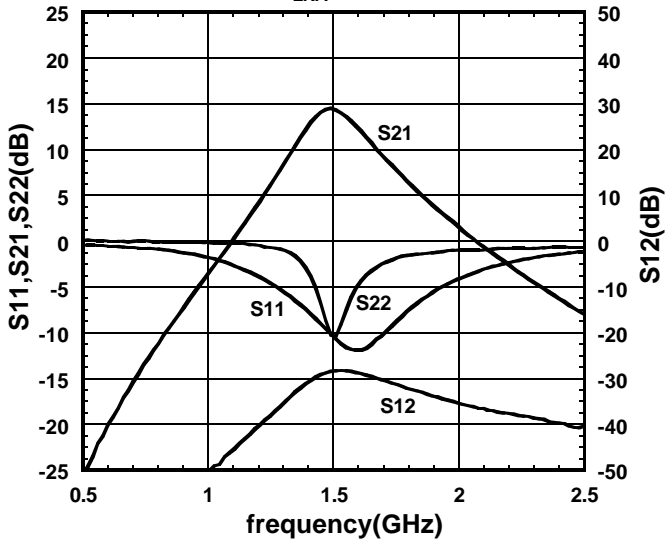

Condition
 $V_{LNA}=2.7\text{V}$
 $V_{MIX}=V_{LO}=0\text{V}$

NF vs. frequency

($V_{LNA}=2.7\text{V}$)

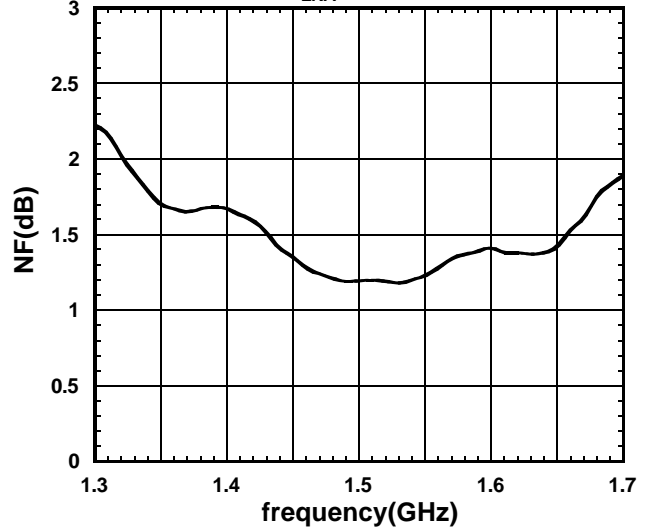

Condition
 $V_{LNA}=2.7\text{V}$
 $V_{MIX}=V_{LO}=0\text{V}$

RF POWER vs. Pout,IM3

($V_{LNA}=2.7\text{V}, \text{freq}=1489+1489.1\text{MHz}$)

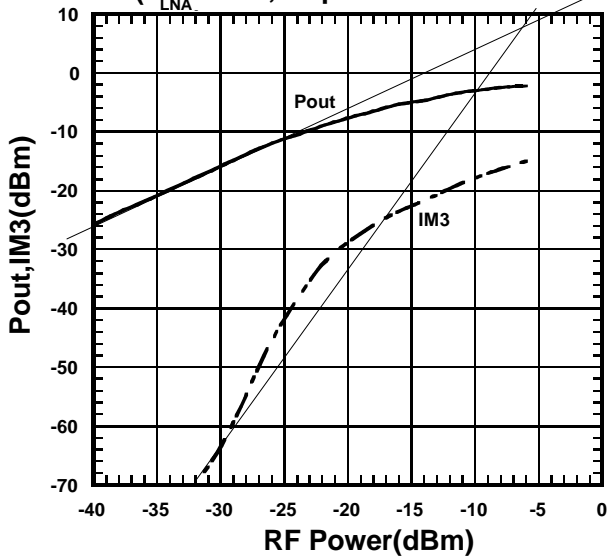

Condition
 $f_{RF}=1489.0+1489.1\text{MHz}$
 $V_{LNA}=2.7\text{V}$
 $V_{MIX}=V_{LO}=0\text{V}$

■ TYPICAL CHARACTERISTICS (MIXER 1.5GHz band $f_{LO}=1619\text{MHz}$)

Conversion Gain , Noise Figure vs. RF Frequency

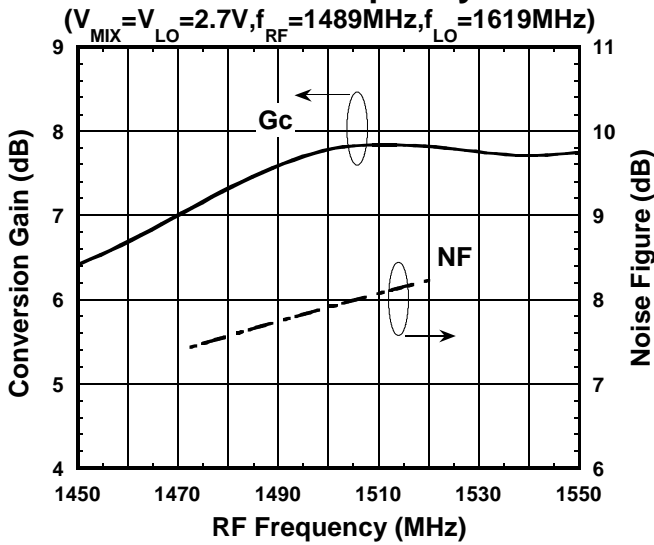

Condition
 $f_{IF}=130\text{MHz}$
 $P_{RF}=-30\text{dBm}$
 $P_{LO}=-10\text{dBm}$
 $V_{LNA}=0\text{V}$
 $V_{MIX}=V_{LO}=2.7\text{V}$
 Upper LOCAL

IF , IM3 vs. RF Power

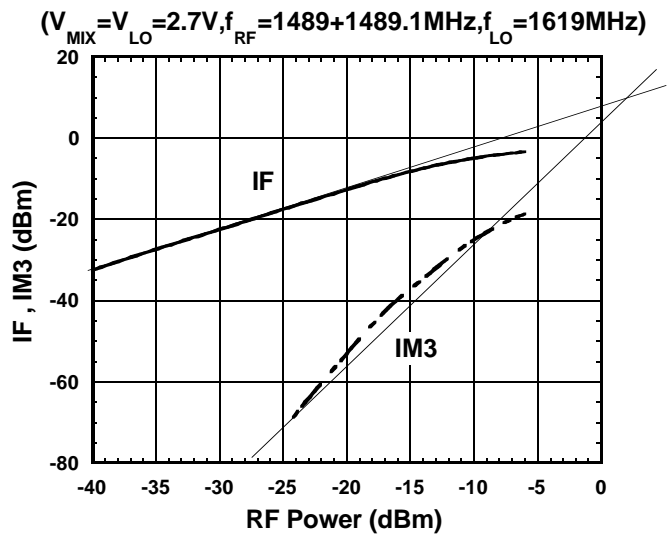

Condition
 $f_{IF}=130\text{MHz}$
 $f_{RF}=1489\text{MHz}, P_{RF}=-30\text{dBm}$
 $f_{LO}=1619\text{MHz}$
 $V_{LNA}=0\text{V}$
 $V_{MIX}=V_{LO}=2.7\text{V}$

■ TYPICAL CHARACTERISTICS (MIXER 1.5GHz band $f_{LO}=1619\text{MHz}$)

MIXER IN IMPEDANCE

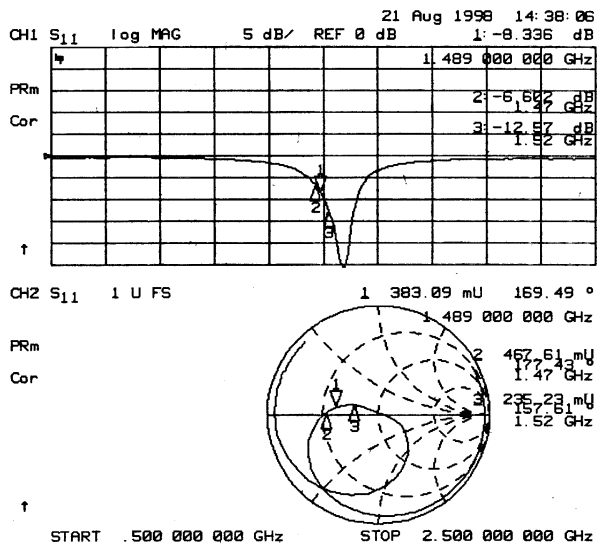

Condition
 $V_{LNA}=0\text{V}$
 $V_{MIX}=V_{LO}=2.7\text{V}$

LOCAL IN IMPEDANCE

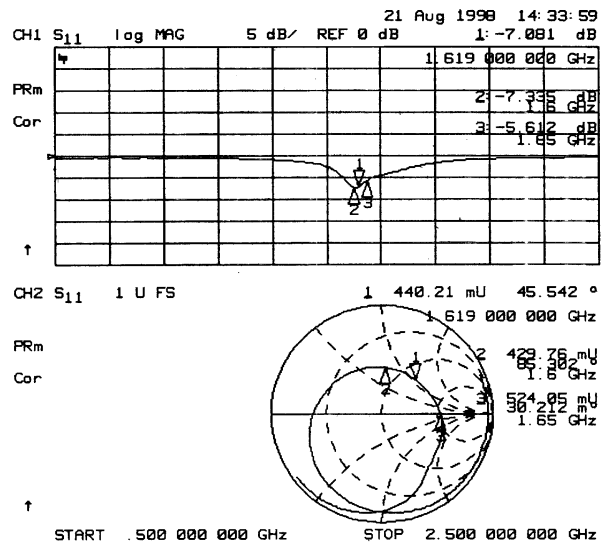

Condition
 $V_{LNA}=0\text{V}$
 $V_{MIX}=V_{LO}=2.7\text{V}$

IF OUT IMPEDANCE

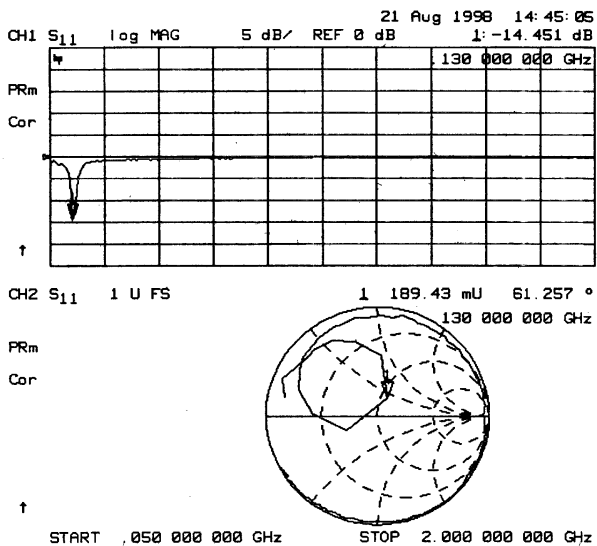

Condition
 $V_{LNA}=0\text{V}$
 $V_{MIX}=V_{LO}=2.7\text{V}$

■ TYPICAL CHARACTERISTICS (LNA+MIXER 1.9GHz band $f_{LO}=1660\text{MHz}$)

Conversion Gain , Noise Figure vs. RF Frequency

($V_{LNA}=V_{MIX}=V_{LO}=2.7\text{V}$)

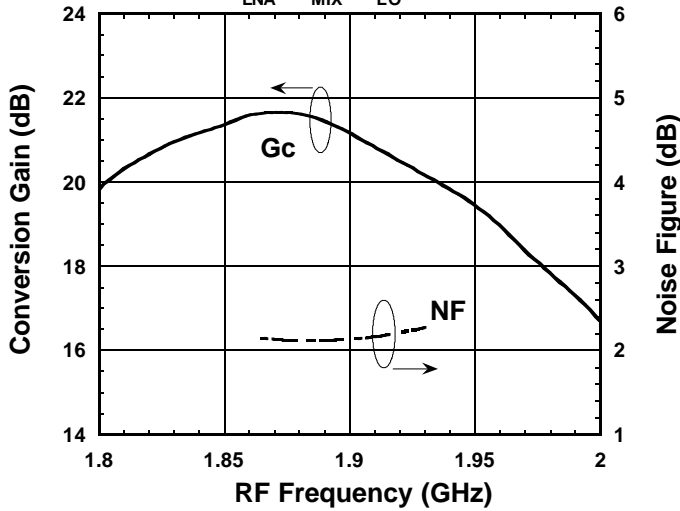

Condition
 $f_{IF}=240\text{MHz}$
 $P_{RF}=-50\text{dBm}$
 $P_{LO}=-10\text{dBm}$
 $V_{LNA}=V_{MIX}=V_{LO}=2.7\text{V}$
 Lower LOCAL

Conversion Gain , Noise Figure vs. LO Power

($V_{LNA}=V_{MIX}=V_{LO}=2.7\text{V}, f_{RF}=1900\text{MHz}, f_{LO}=1660\text{MHz}$)

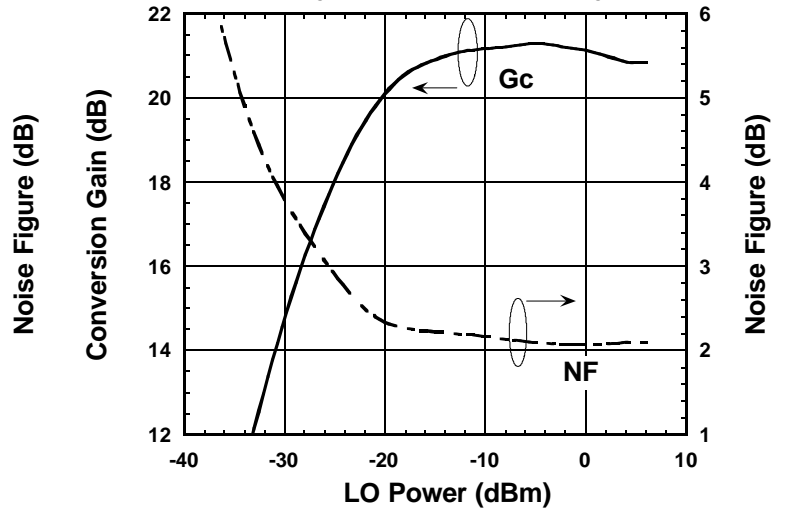

Condition
 $f_{IF}=240\text{MHz}$
 $f_{RF}=1900\text{MHz}, P_{RF}=-50\text{dBm}$
 $f_{LO}=1660\text{MHz}$
 $V_{LNA}=V_{MIX}=V_{LO}=2.7\text{V}$

Output-IP3 , Input-IP3 vs. LO Power

($V_{LNA}=V_{MIX}=V_{LO}=2.7\text{V}, f_{RF}=1900+1900.1\text{MHz}, f_{LO}=1660\text{MHz}$)

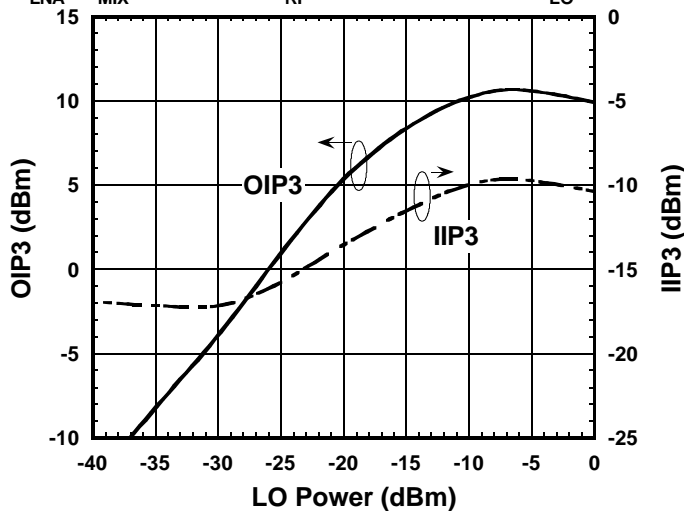

Condition
 $f_{IF}=240\text{MHz}$
 $f_{RF1}=1900.0\text{MHz}, P_{RF}=-35\text{dBm}$
 $f_{RF2}=1900.1\text{MHz}$
 $f_{LO}=1660\text{MHz}$
 $V_{LNA}=V_{MIX}=V_{LO}=2.7\text{V}$

$$OIP3 = \frac{3IF-IM3}{2}$$

$$IIP3 = \frac{3IF-IM3}{2} - G_c$$

@ $P_{RF}=-35\text{dBm}$

■ TYPICAL CHARACTERISTICS (LNA+MIXER 1.9GHz band $f_{LO}=1660\text{MHz}$)

RF IN IMPEDANCE

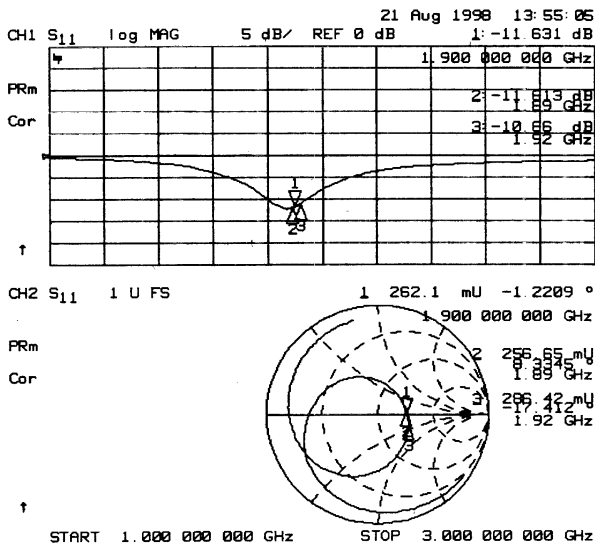

Condition
 $V_{LNA}=2.7\text{V}$
 $V_{MIX}=V_{LO}=2.7\text{V}$

LOCAL IN IMPEDANCE

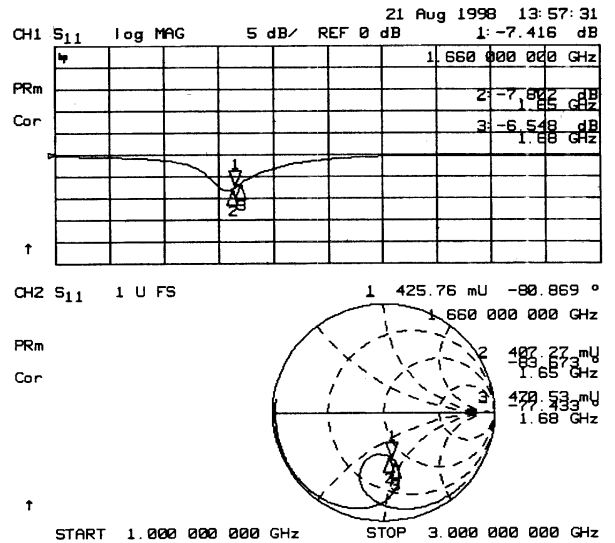

Condition
 $V_{LNA}=2.7\text{V}$
 $V_{MIX}=V_{LO}=2.7\text{V}$

IF OUT IMPEDANCE

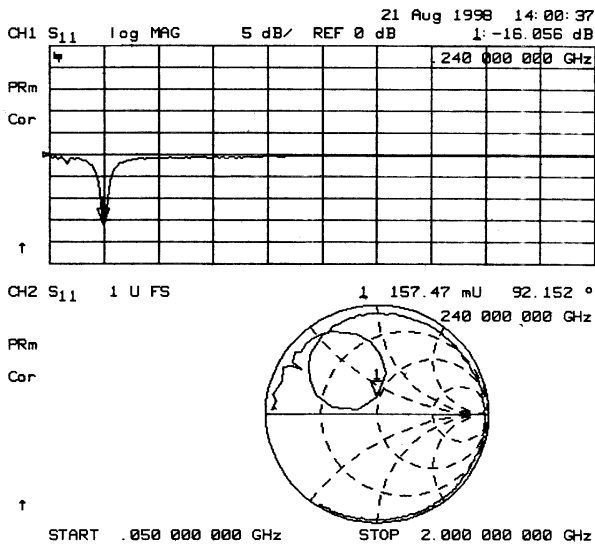

Condition
 $V_{LNA}=2.7\text{V}$
 $V_{MIX}=V_{LO}=2.7\text{V}$

■ TYPICAL CHARACTERISTICS (LNA+MIXER 1.9GHz band $f_{LO}=1660\text{MHz}$)

Conversion Gain , Noise Figure

vs. V_{LNA}, V_{MIX}, V_{LO}
 ($f_{RF}=1900\text{MHz}, f_{LO}=1660\text{MHz}$)

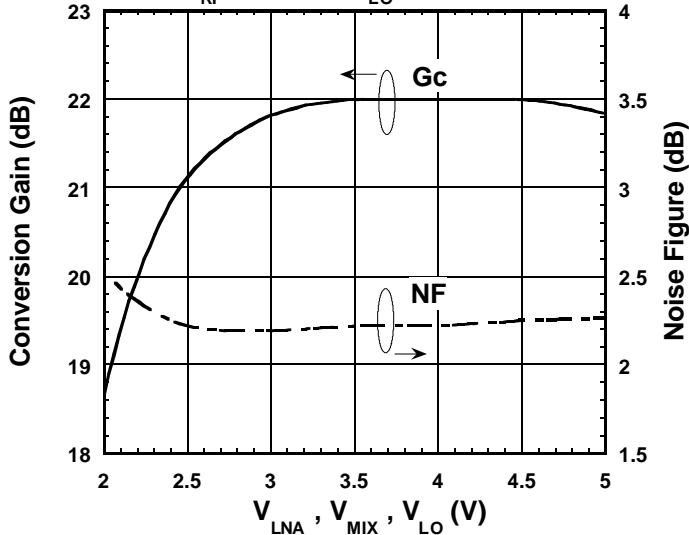

Condition
 $f_{IF}=240\text{MHz}$
 $f_{RF}=1900\text{MHz}, P_{RF}=-50\text{dBm}$
 $f_{LO}=1660\text{MHz}, P_{LO}=-10\text{dBm}$

Output-IP3 , Input-IP3 vs. V_{LNA}, V_{MIX}, V_{LO}

($f_{RF}=1900+1900.1\text{MHz}, f_{LO}=1660\text{MHz}$)

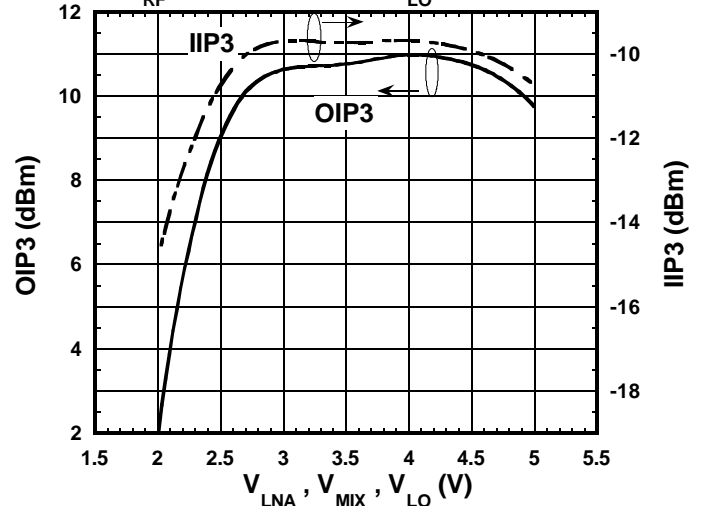

Condition
 $f_{IF}=240\text{MHz}$
 $f_{RF1}=1900.0\text{MHz}, P_{RF}=-35\text{dBm}$
 $f_{RF2}=1900.1\text{MHz}$
 $f_{LO}=1660\text{MHz}, P_{LO}=-10\text{dBm}$

$$OIP3 = \frac{3IF-IM3}{2}$$

$$IIP3 = \frac{3IF-IM3}{2} - G_c$$

@ $P_{RF}=-35\text{dBm}$

IF , IM3 vs. RF Power

($V_{LNA}=V_{MIX}=V_{LO}=2.7\text{V}, f_{RF}=1900+1900.1\text{MHz}, f_{LO}=1660\text{MHz}$)

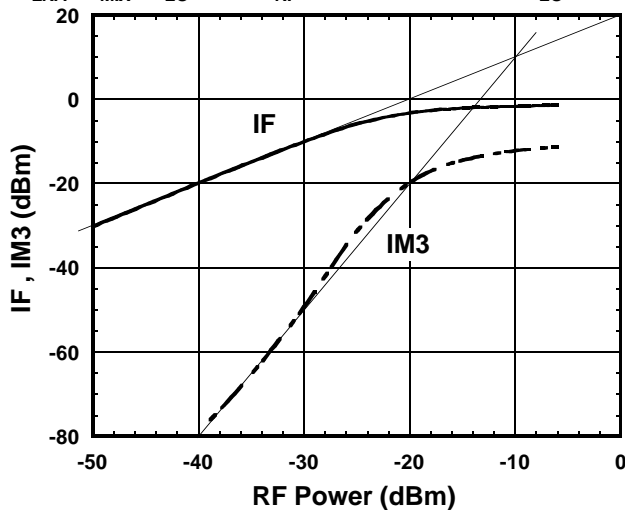

Condition
 $f_{IF}=240\text{MHz}$
 $f_{RF1}=1900.0\text{MHz}$
 $f_{RF2}=1900.1\text{MHz}$
 $f_{LO}=1660\text{MHz}, P_{LO}=-10\text{dBm}$
 $V_{LNA}=V_{MIX}=V_{LO}=2.7\text{V}$

IF vs. RF Power

($V_{LNA}=V_{MIX}=V_{LO}=2.7\text{V}, f_{RF}=1900\text{MHz}, f_{LO}=1660\text{MHz}$)

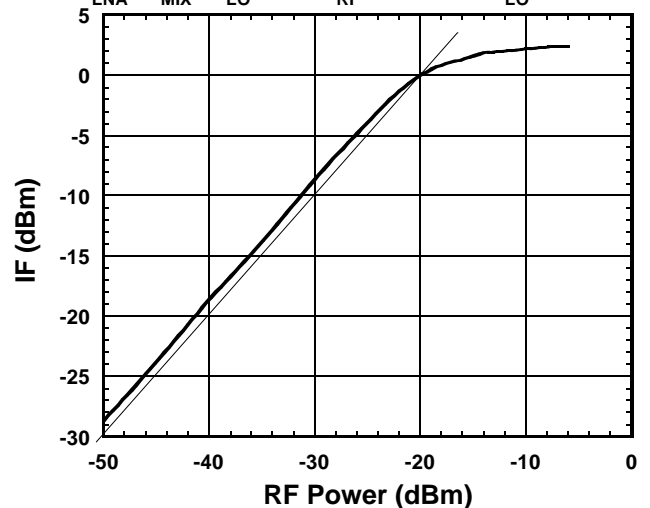

Condition
 $f_{IF}=240\text{MHz}$
 $f_{RF}=1900\text{MHz}$
 $f_{LO}=1660\text{MHz}, P_{LO}=-10\text{dBm}$
 $V_{LNA}=V_{MIX}=V_{LO}=2.7\text{V}$

■ TYPICAL CHARACTERISTICS (LNA+MIXER 1.9GHz band $f_{LO}=1660\text{MHz}$)

Conversion Gain , Noise Figure vs. Temperature

($V_{LNA}=V_{MIX}=V_{LO}=2.7\text{V}, f_{RF}=1900\text{MHz}, f_{LO}=1660\text{MHz}$)

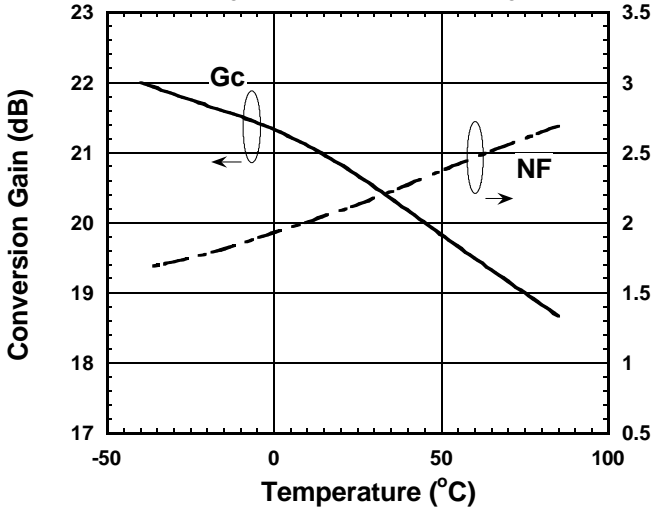

Condition
 $f_{IF}=240\text{MHz}$
 $f_{RF}=1900\text{MHz}, P_{RF}=-50\text{dBm}$
 $f_{LO}=1900\text{MHz}, P_{LO}=-10\text{dBm}$
 $V_{LNA}=V_{MIX}=V_{LO}=2.7\text{V}$

Output-IP3 , Input-IP3 vs. Temperature

($V_{LNA}=V_{MIX}=V_{LO}=2.7\text{V}, f_{RF}=1900+1900.1\text{MHz}, f_{LO}=1660\text{MHz}$)

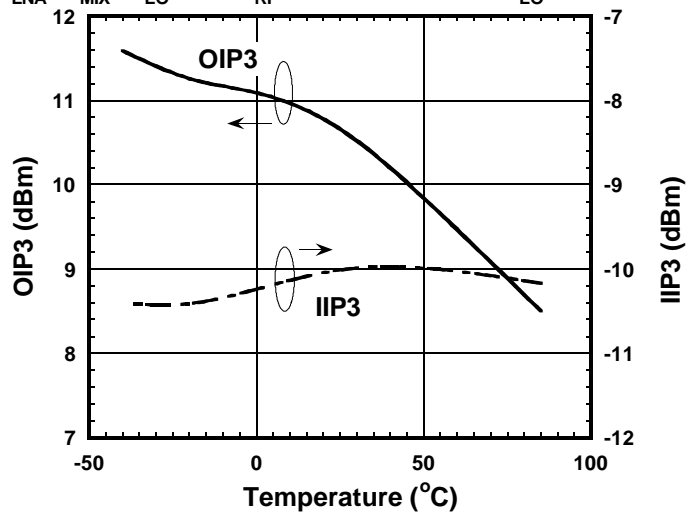

Condition
 $f_{IF}=240\text{MHz}$
 $f_{RF1}=1900.0\text{MHz}, P_{RF}=-35\text{dBm}$
 $f_{RF2}=1900.1\text{MHz}$
 $f_{LO}=1660\text{MHz}$
 $V_{LNA}=V_{MIX}=V_{LO}=2.7\text{V}$

$$OIP3 = \frac{3IF-IM3}{2}$$

$$IIP3 = \frac{3IF-IM3}{2} - G_c$$

@ $P_{RF}=-35\text{dBm}$

RF IN-LOCAL IN Isolation

($V_{LNA}=2.7\text{V}$)

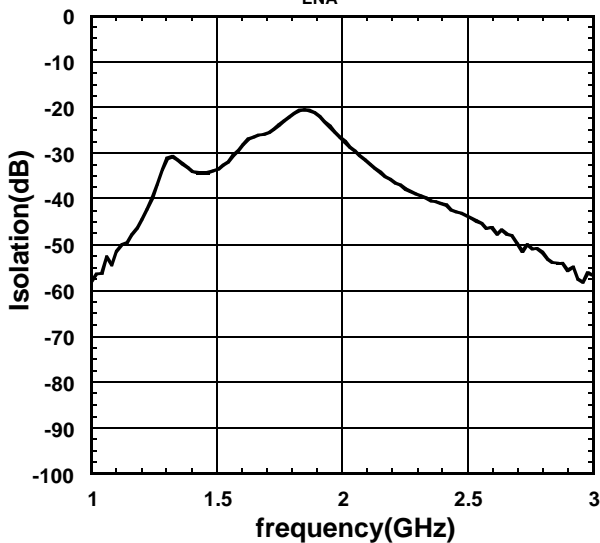

Condition
 $V_{LNA}=2.7\text{V}$
 $V_{MIX}=V_{LO}=2.7\text{V}$
 Port1:RF IN
 Port2:LOCAL IN

RF OUT-MIXER IN Isolation

($V_{LNA}=2.7\text{V}$)

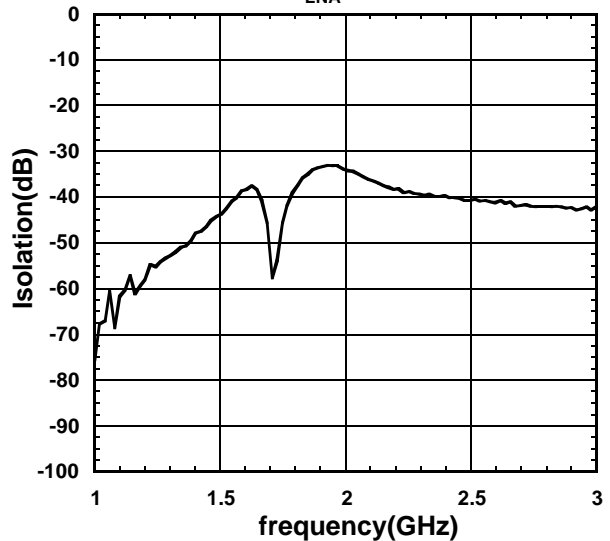

Condition
 $V_{LNA}=2.7\text{V}$
 $V_{MIX}=V_{LO}=2.7\text{V}$
 Port1:RF OUT
 Port2:MIXER IN

■ TYPICAL CHARACTERISTICS (LNA+MIXER 1.9GHz band $f_{LO}=2095.2\text{MHz}$)

**Conversion Gain , Noise Figure
vs. RF Frequency**

($V_{LNA}=V_{MIX}=V_{LO}=3.0\text{V}$)

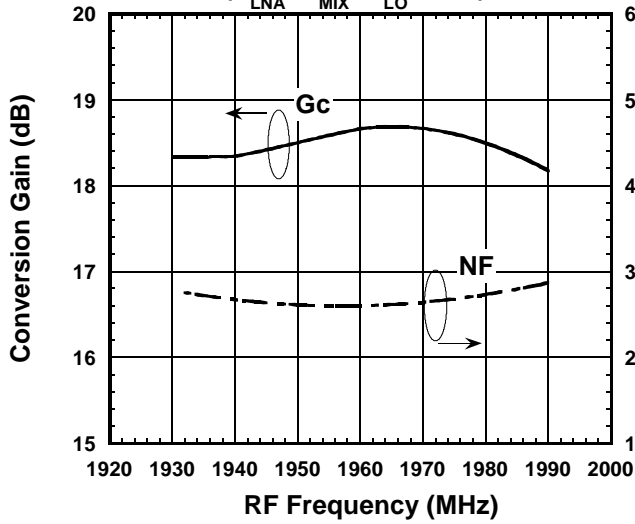

Condition
 $f_{IF}=135.2\text{MHz}$
 $P_{RF}=-50\text{dBm}$
 $P_{LO}=-8\text{dBm}$
 $V_{LNA}=V_{MIX}=V_{LO}=3.0\text{V}$
 Upper LOCAL

IF , IM3 vs. RF Power

($V_{LNA}=V_{MIX}=V_{LO}=3.0\text{V}, f_{RF}=1960+1960.1\text{MHz}, f_{LO}=2095.2\text{MHz}$)

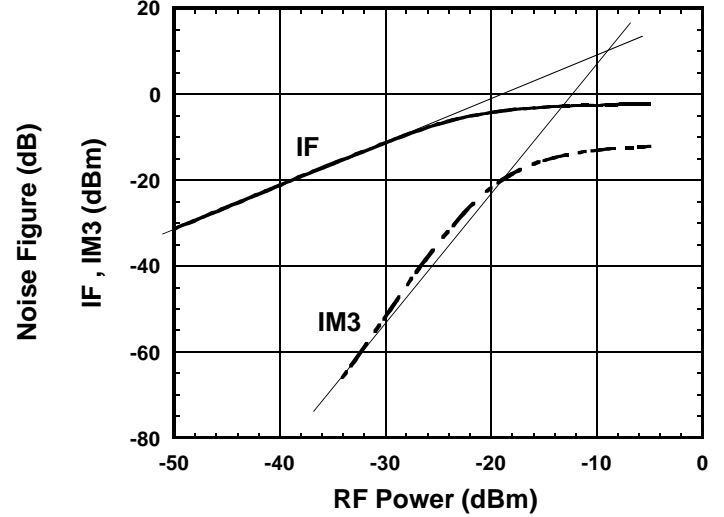

Condition
 $f_{IF}=135.2\text{MHz}$
 $f_{RF1}=1960.0\text{MHz}$
 $f_{RF2}=1960.1\text{MHz}$
 $f_{LO}=2095.2\text{MHz}, P_{LO}=-8\text{dBm}$
 $V_{LNA}=V_{MIX}=V_{LO}=3.0\text{V}$

NJG1705V

■ TYPICAL CHARACTERISTICS (LNA 1.9GHz band $f_{LO}=1660\text{MHz}$)

S11,S21,S12,S22 Vs. frequency

($V_{LNA}=2.7\text{V}$)

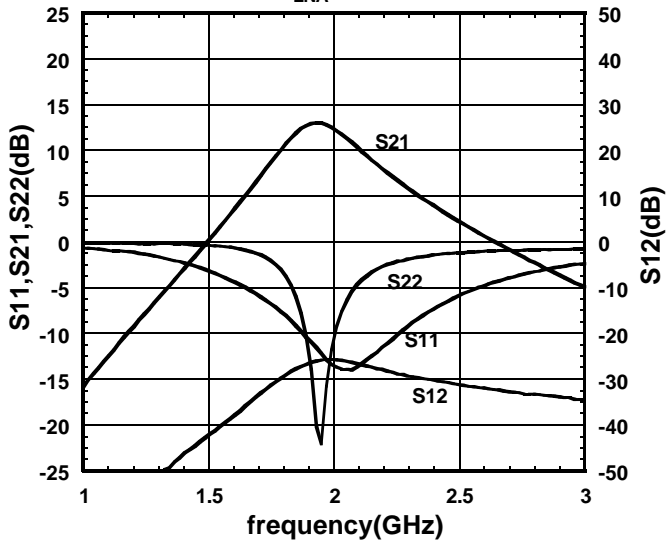

Condition
 $V_{LNA}=2.7\text{V}$
 $V_{MIX}=V_{LO}=0\text{V}$

NF vs. frequency

($V_{LNA}=2.7\text{V}$)

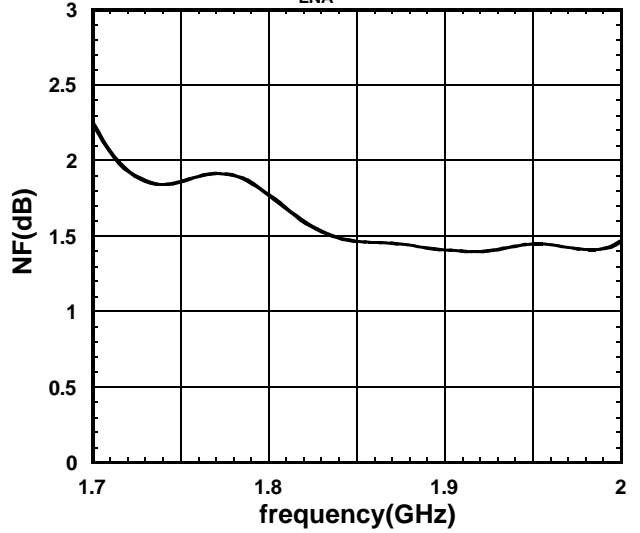

Condition
 $V_{LNA}=2.7\text{V}$
 $V_{MIX}=V_{LO}=0\text{V}$

RF POWER vs. Pout,IM3

($V_{LNA}=2.7\text{V}, \text{freq}=1900+1900.1\text{MHz}$)

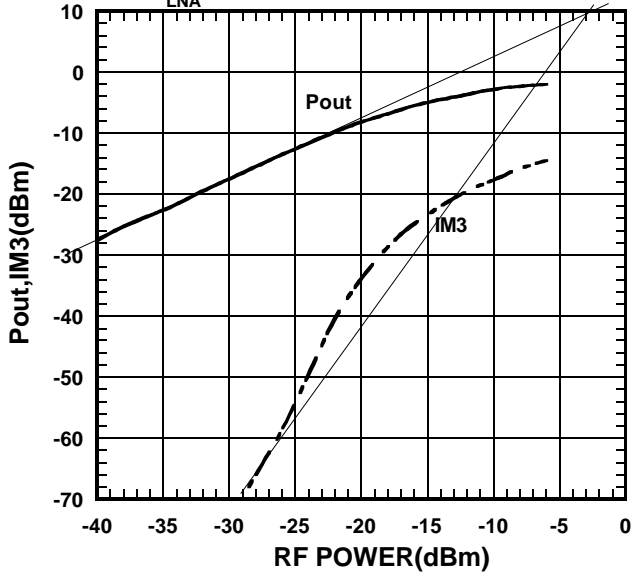

Condition
 $f_{RF}=1900.0+1900.1\text{MHz}$
 $V_{LNA}=2.7\text{V}$
 $V_{MIX}=V_{LO}=0\text{V}$

■ TYPICAL CHARACTERISTICS (MIXER 1.9GHz band $f_{LO}=1660\text{MHz}$)

Conversion Gain , Noise Figure vs. RF Frequency

($V_{MIX}=V_{LO}=2.7\text{V}$)

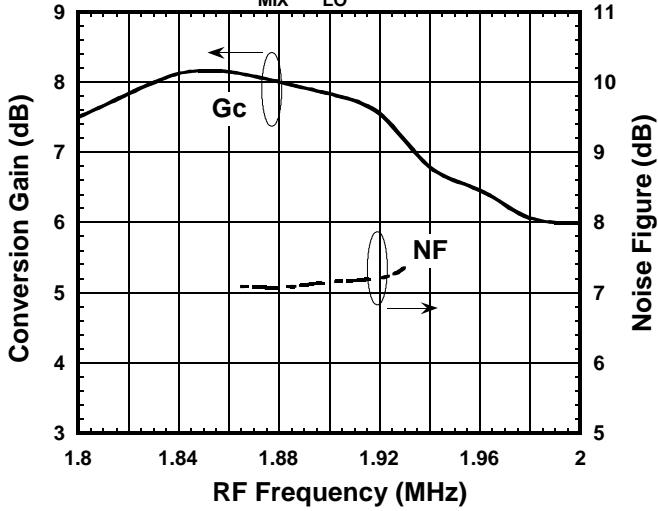

Condition
 $f_{IF}=240\text{MHz}$
 $P_{RF}=-30\text{dBm}$
 $P_{LO}=-10\text{dBm}$
 $V_{LNA}=0\text{V}$
 $V_{MIX}=V_{LO}=2.7\text{V}$
 Lower LOCAL

IF , IM3 vs. RF Power

($V_{MIX}=V_{LO}=2.7\text{V}, f_{RF}=1900+1900.1\text{MHz}, f_{LO}=1660\text{MHz}$)

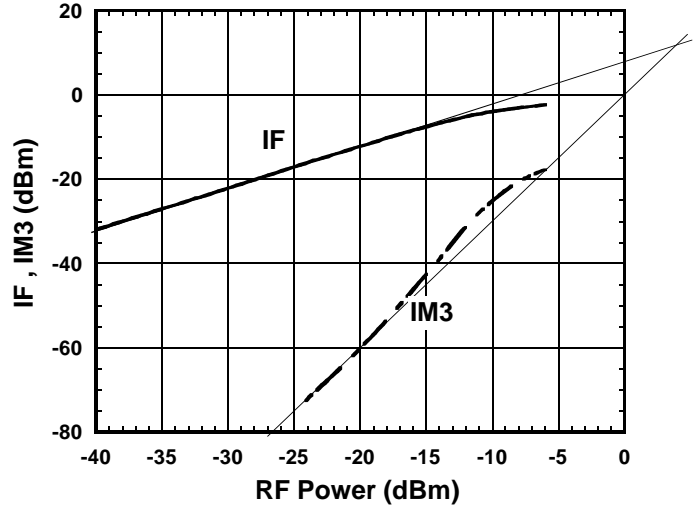

Condition
 $f_{IF}=240\text{MHz}$
 $f_{RF}=1900\text{MHz}, P_{RF}=-30\text{dBm}$
 $f_{LO}=1660\text{MHz}$
 $V_{LNA}=0\text{V}$
 $V_{MIX}=V_{LO}=2.7\text{V}$

■ TYPICAL CHARACTERISTICS (MIXER 1.9GHz band $f_{LO}=1660\text{MHz}$)

MIXER IN IMPEDANCE

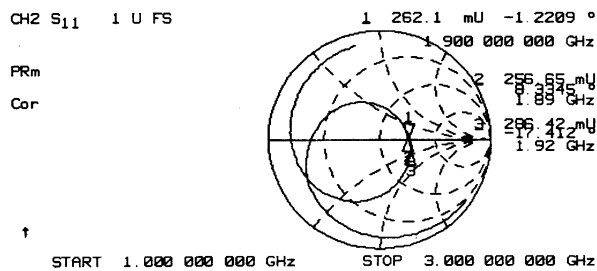
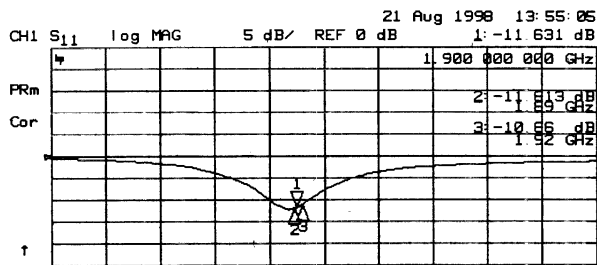

Condition
 $V_{LNA}=0V$
 $V_{MIX}=V_{LO}=2.7V$

LOCAL IN IMPEDANCE

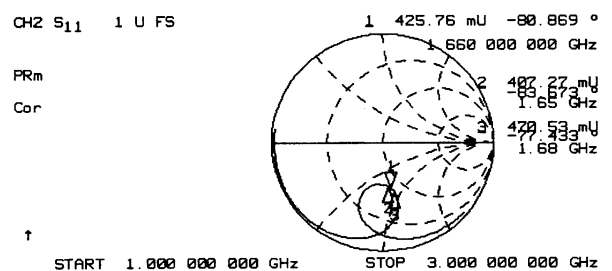
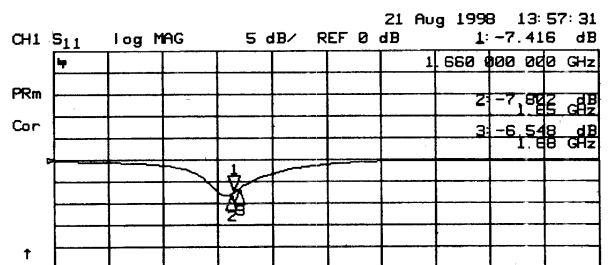

Condition
 $V_{LNA}=0V$
 $V_{MIX}=V_{LO}=2.7V$

IF OUT IMPEDANCE

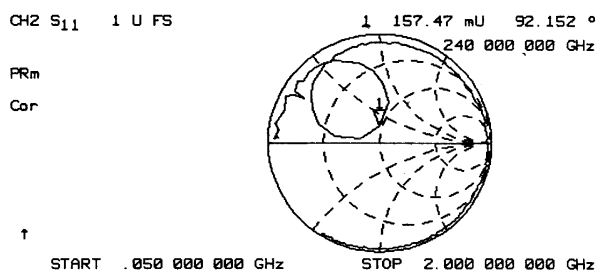
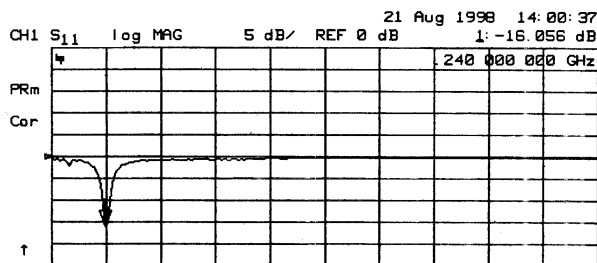

Condition
 $V_{LNA}=0V$
 $V_{MIX}=V_{LO}=2.7V$

APPLICATION CIRCUIT

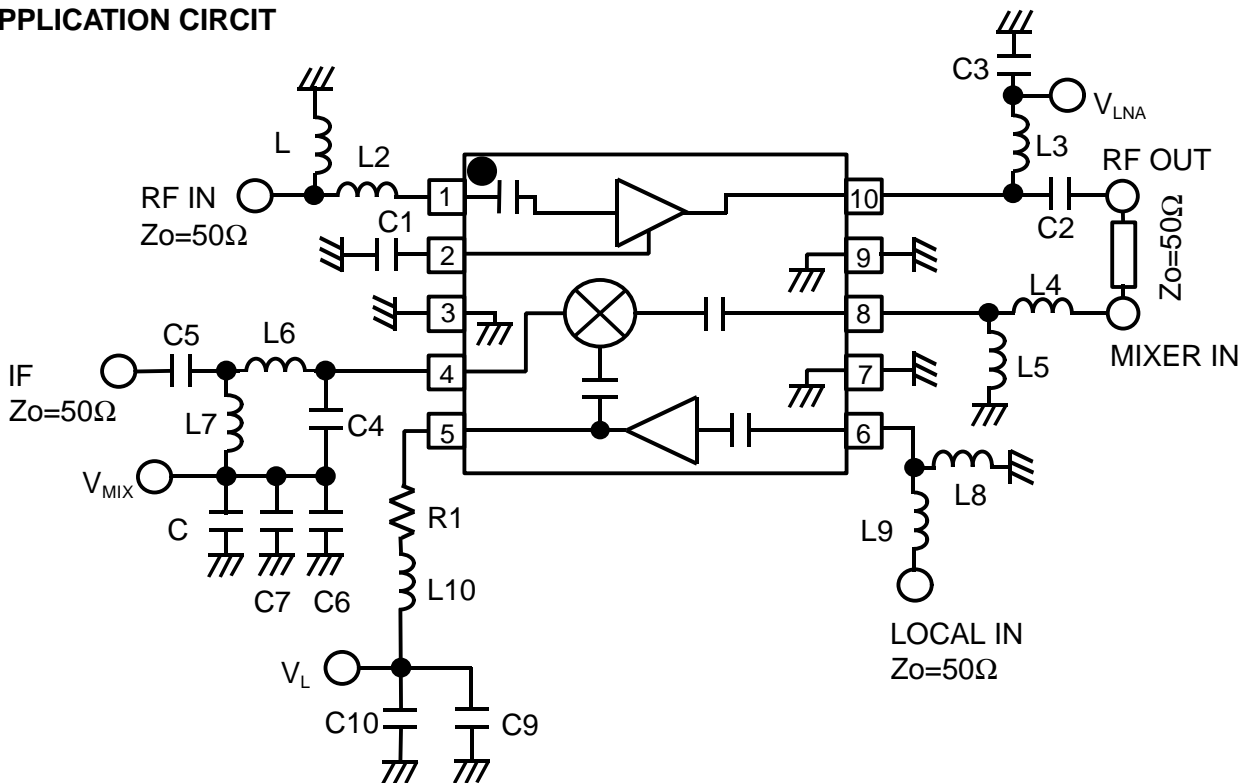

PARTS LIST

PART ID	1.5GHz band		1.9GHz band		COMMENT
	Upper LOCAL	Lower LOCAL	Upper LOCAL		
	$f_{LO}=1619\text{MHz}$ $f_{IF}=130\text{MHz}$	$f_{LO}=1660\text{MHz}$ $f_{IF}=240\text{MHz}$	$f_{LO}=2095.2\text{MHz}$ $f_{IF}=135.2\text{MHz}$		
L1	10nH	4.7nH	4.7nH	TAIYO-YUDEN (HK1005)	
L2	10nH	4.7nH	4.7nH	TAIYO-YUDEN (HK1005)	
L3	8.2nH	4.7nH	4.7nH	TAIYO-YUDEN (HK1005)	
L4	12nH	4.7nH	4.7nH	TAIYO-YUDEN (HK1005)	
L5	8.2nH	4.7nH	3.9nH	TAIYO-YUDEN (HK1005)	
L6	82nH	47nH	82nH	TAIYO-YUDEN (HK1005)	
L7	33nH	18nH	33nH	TAIYO-YUDEN (HK1005)	
L8	15nH	12nH	8.2nH	TAIYO-YUDEN (HK1005)	
L9	15nH	18nH	10nH	TAIYO-YUDEN (HK1005)	
L10	6.8nH	6.8nH	3.9nH	TAIYO-YUDEN (HK1005)	
C1	30pF	30pF	30pF	MURATA(GRM36)	
C2	0.5nH	0.5pF	0.5pF	MURATA(GRM36)	
C3	1000pF	1000pF	1000pF	MURATA(GRM36)	
C4	11pF	5pF	11pF	MURATA(GRM36)	
C5	1000pF	1000pF	1000pF	MURATA(GRM36)	
C6	10pF	10pF	10pF	MURATA(GRM36)	
C7	100pF	100pF	100pF	MURATA(GRM36)	
C8	1000pF	1000pF	1000pF	MURATA(GRM36)	
C9	1000pF	1000pF	1000pF	MURATA(GRM36)	
C10	100pF	100pF	100pF	MURATA(GRM36)	
R1	10Ω	10Ω	10Ω	TAMA Electronics (CRG16G)	

NJG1705V

RECOMMENDED PCB DESIGN

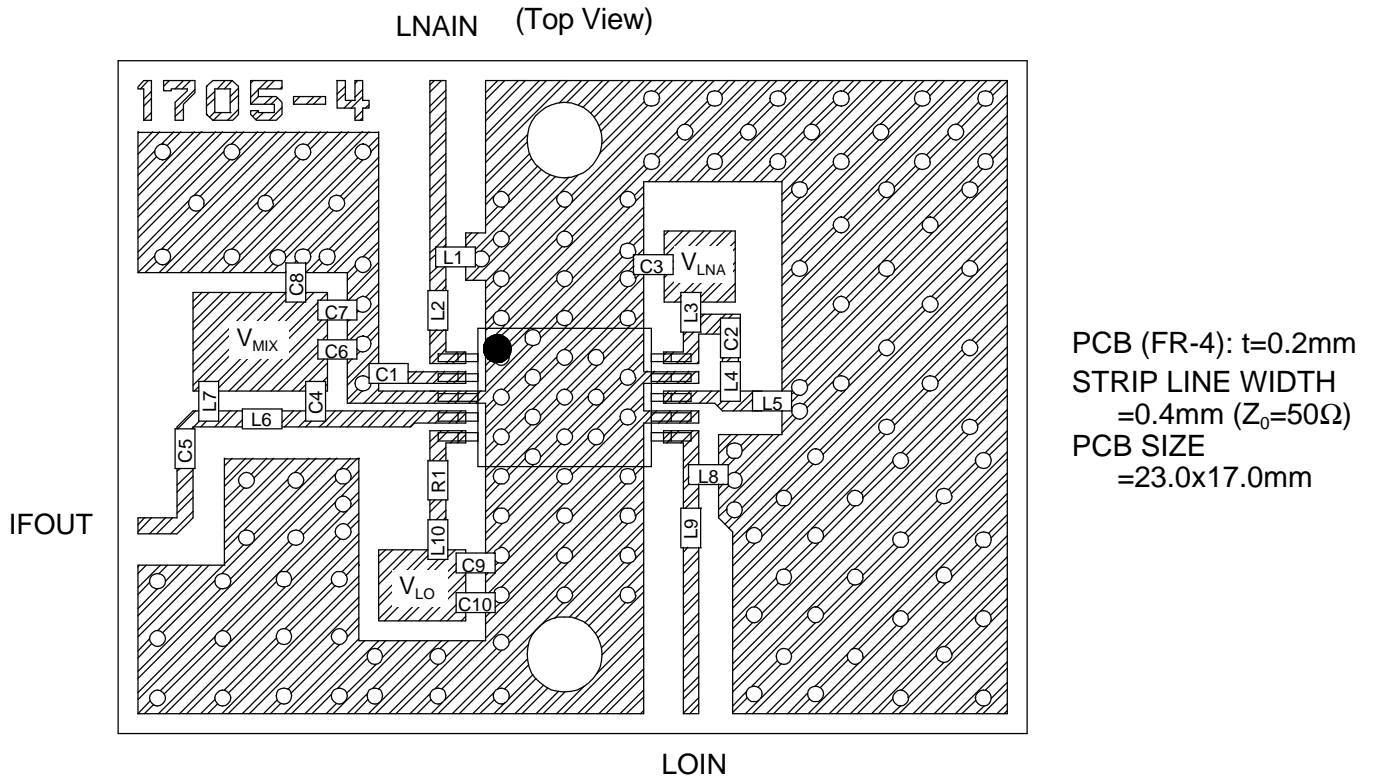

Caution on using devices.

- [1] Please place R1 close to the VLO terminal (5th pin), and L10 to R1.
- [2] Please place C1 close to the LNACAP terminal (2nd pin).
- [3] Please place C3 close to L3.
- [4] Please place C3 close to C6, C7, and C8
- [5] Please place L10 close to C9, C10.

MEASURING BLOCK DISGRSM

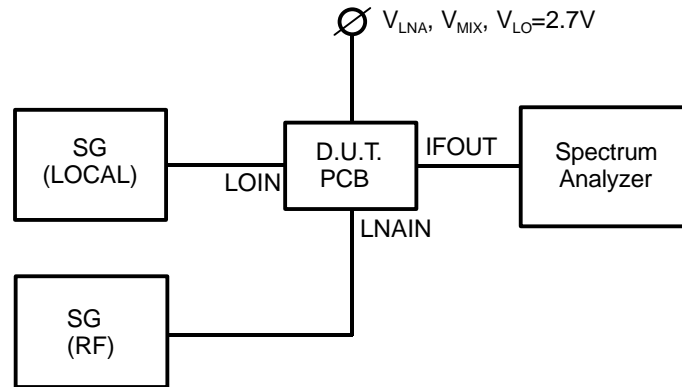

Conversion Gain Measurement Block Diagram

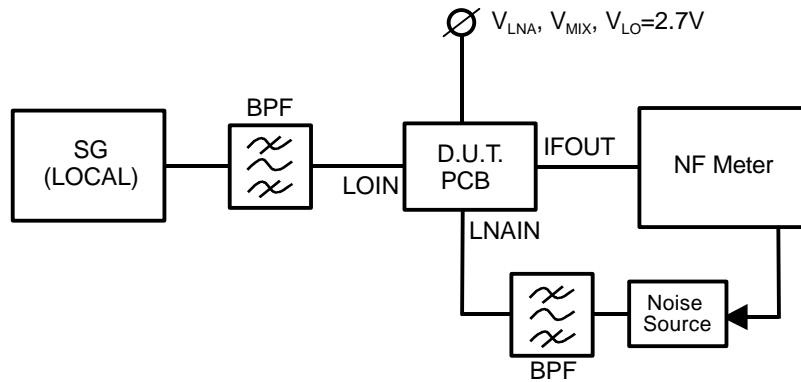

Noise Figure Measurement Block Diagram

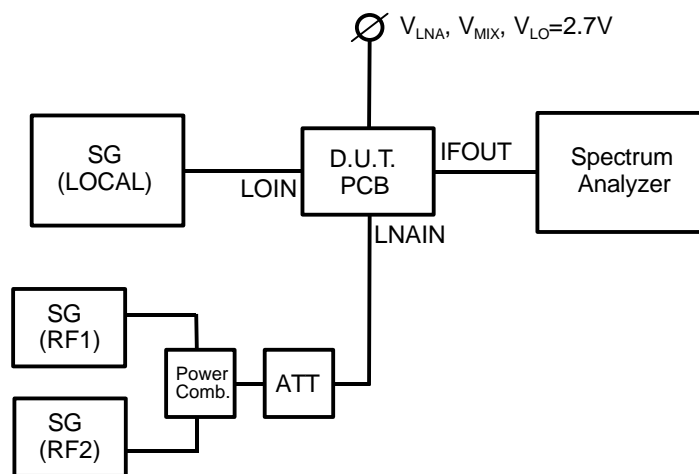

IF, IM3, IM5 Measurement Block Diagram

NJG1705V

PACKAGE OUTLINE (SSOP10)

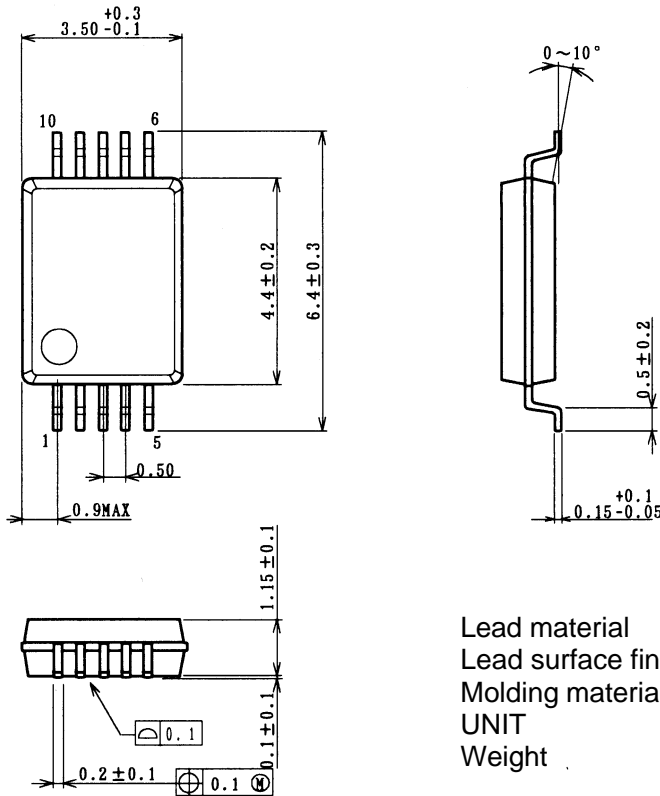

Lead material	: Copper
Lead surface finish	: Solder plating
Molding material	: Epoxy resin
UNIT	: mm
Weight	: 41mg

Cautions on using this product

This product contains Gallium-Arsenide (GaAs) which is a harmful material.

- Do NOT eat or put into mouth.
- Do NOT dispose in fire or break up this product.
- Do NOT chemically make gas or powder with this product.
- To waste this product, please obey the relating law of your country.

[CAUTION]

The specifications on this databook are only given for information, without any guarantee as regards either mistakes or omissions. The application circuits in this databook are described only to show representative usages of the product and not intended for the guarantee or permission of any right including the industrial rights.

This product may be damaged with electric static discharge (ESD) or spike voltage. Please handle with care to avoid these damages.