

为您的产品保驾护航

PRODUCT DATASHEET

Electro-Static Discharge

JEN0603-5V-LG ESD

## Features

- Ultra small package: 0.6x0.3x0.3mm(DFN0603)
- Protects one data or power line
- Very low capacitance: 2.5pF typical
- Ultra low leakage: nA level
- Operating voltage: 5V
- Low clamping voltage
- 2-pin leadless package
- Complies with following standards:
  - IEC 61000-4-2 (ESD) immunity test  
Air discharge:  $\pm 15\text{kV}$   
Contact discharge:  $\pm 8\text{kV}$
  - IEC61000-4-5 (Lightning) 2A (8/20 $\mu\text{s}$ )
- RoHS compliant

## Applications

- Cellular Handsets and Accessories
- Personal Digital Assistants
- Notebooks and Handhelds
- Portable Instrumentation
- Digital Cameras
- Peripherals
- Audio Players
- Keypads, Side Keys, USB 2.0, LCD Displays

## Pin Description



## Schematic Diagram

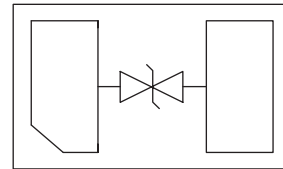

## Limiting Values( $T_A = 25\text{ }^\circ\text{C}$ , unless otherwise specified)

Symbol	Parameter	Conditions	Value	Unit
V <sub>ESD</sub>	Electrostatic Discharge Voltage	IEC 61000-4-2;Contact Discharge	$\pm 8$	kV
		IEC 61000-4-2;Air Discharge	$\pm 15$	kV
T <sub>J</sub>	Operating Temperature Range	-	-55 to +125	$^\circ\text{C}$
T <sub>stg</sub>	Storage Temperature Range	-	-55 to +150	$^\circ\text{C}$

## Electrical Characteristics( $T_A = 25\text{ }^\circ\text{C}$ , unless otherwise specified)

Symbol	Parameter	Conditions	Min	Typ.	Max	Unit
V <sub>RWM</sub>	Reverse Working Voltage	T <sub>A</sub> =25 $^\circ\text{C}$ ;Pin1 to Pin2 or Pin2 to Pin1	-	-	5.0	V
V <sub>BR</sub>	Breakdown Voltage	I <sub>R</sub> =1mA;Pin1 to Pin2 or Pin2 to Pin1	6.0	-	-	V
I <sub>R</sub>	Reverse Leakage Current	V <sub>RWM</sub> =5V;Pin1 to Pin2 or Pin2 to Pin1	-	-	0.2	$\mu\text{A}$
V <sub>C</sub>	Clamping Voltage	I <sub>PP</sub> =1A(8x20 $\mu\text{s}$ pulse);Pin1 to Pin2 or Pin2 to Pin1	-	-	10	V
C <sub>J</sub>	Junction Capacitance	V <sub>R</sub> =0V,f=1 MHz	-	2.5	3	pF

Typical Characteristics

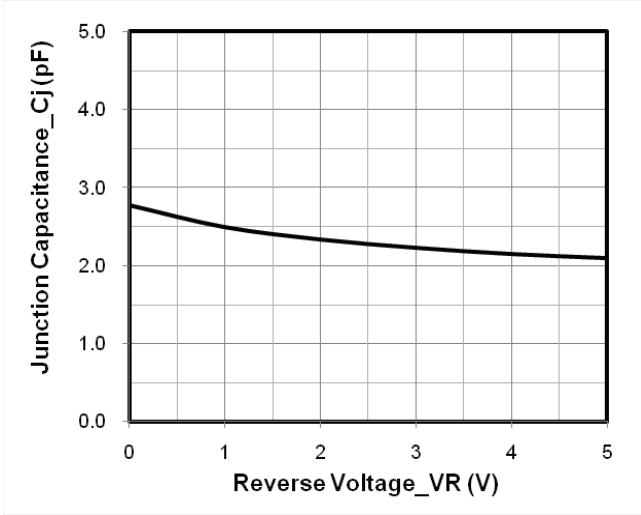

Junction Capacitance vs. Reverse Voltage

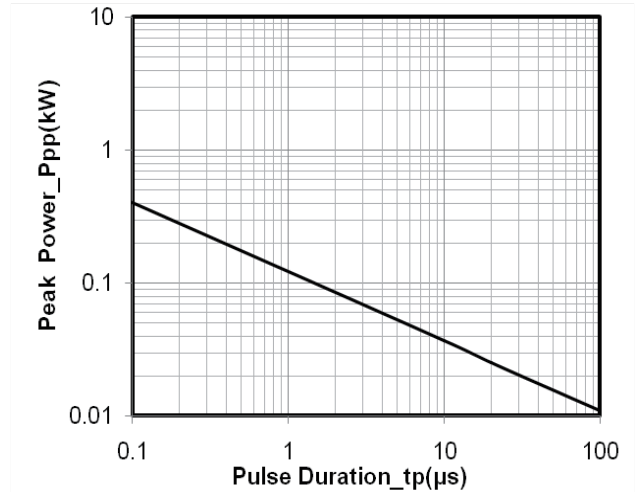

Peak Pulse Power vs. Pulse Time

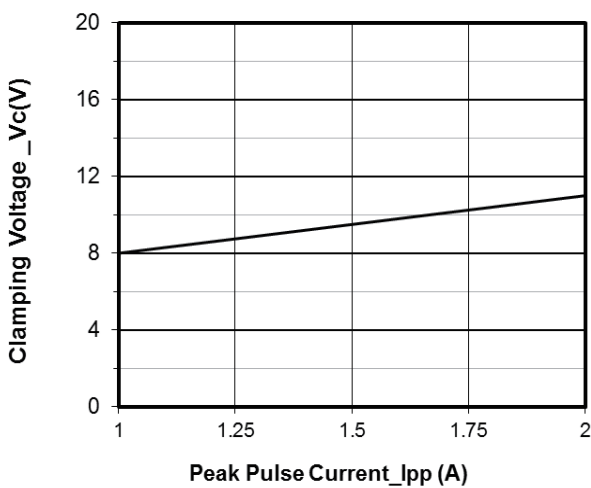

Clamping Voltage vs. Peak Pulse Current (tp = 8/20 μs)

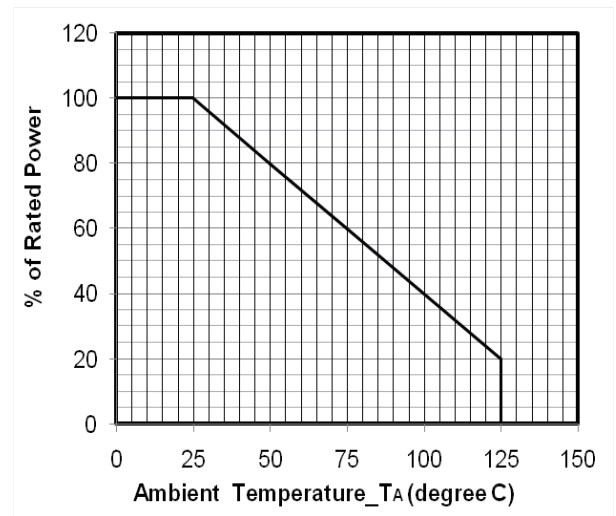

Power Derating Curve

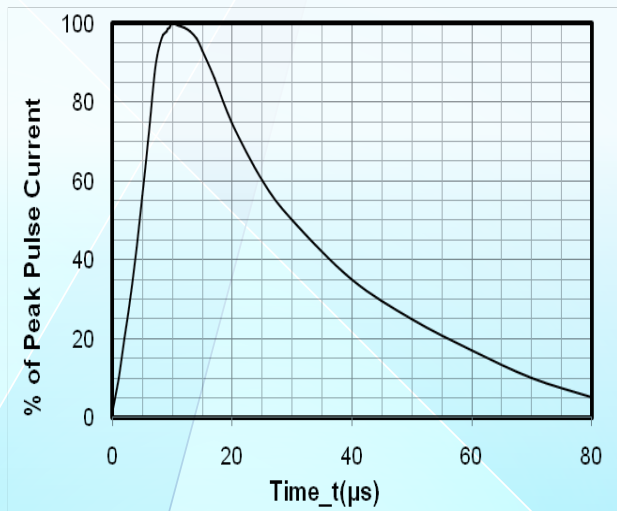

8 X 20 μs Pulse Waveform

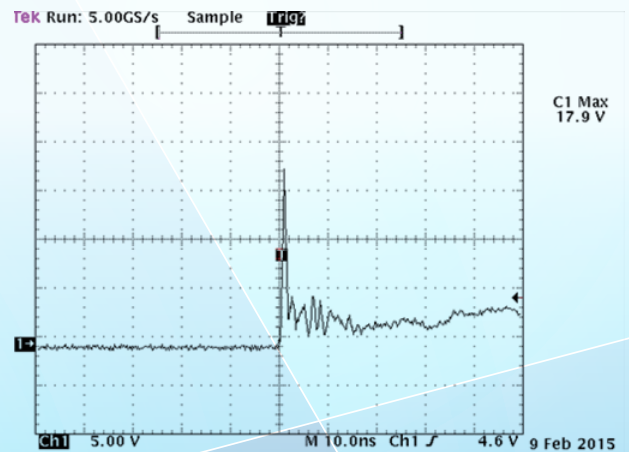

ESD Clamping Voltage  
8 kV Contact per IEC61000-4-2

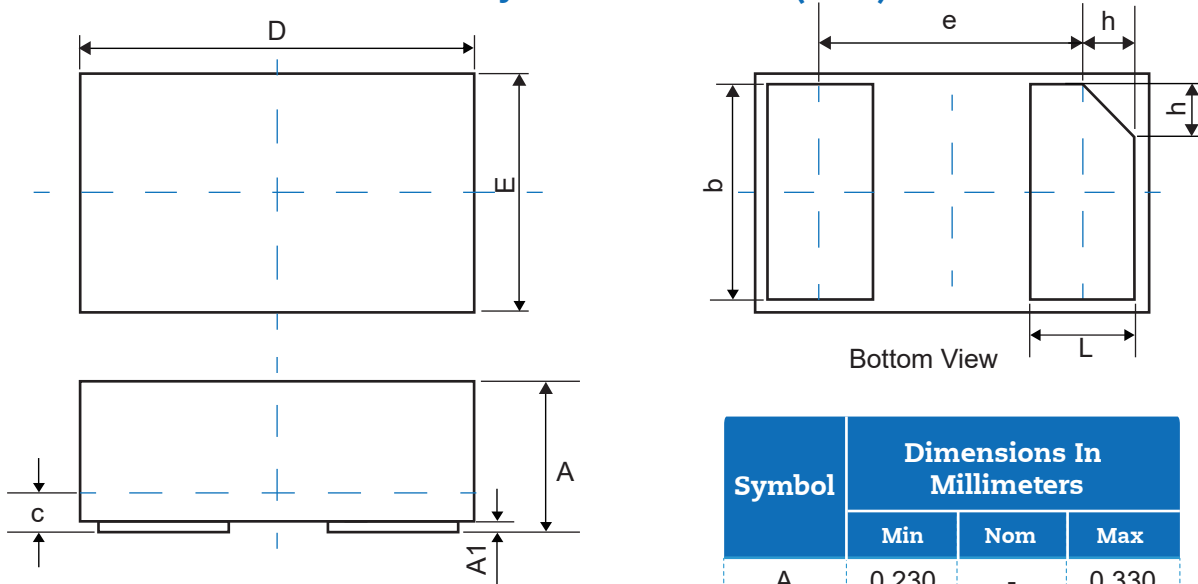
**Physical Dimensions(mm.)**

Symbol	Dimensions In Millimeters		
	Min	Nom	Max
A	0.230	-	0.330
A1	0.000	0.020	0.050
b	0.215	0.245	0.275
c	0.120	0.150	0.180
D	0.550	0.600	0.650
e	0.355 BSC		
E	0.250	0.300	0.350
L	0.160	0.190	0.220
h	0.079 BSC		

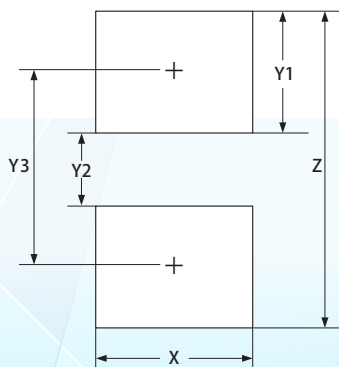
**Suggested Land Pattern**

Symbol	Dimensions Millimeters	
	Min.	Max.
X	0.30	0.012
Y1	0.25	0.010
Y2	0.15	0.006
Y3	0.40	0.016
Z	0.65	0.026

**Packaging Quantity**

Part Number	Size(mm)	Delivery Form	Delivery Quantity
JEN0603-5V-LC	0.6x0.3x0.3	7" T&R	10,000

### Soldering Parameters

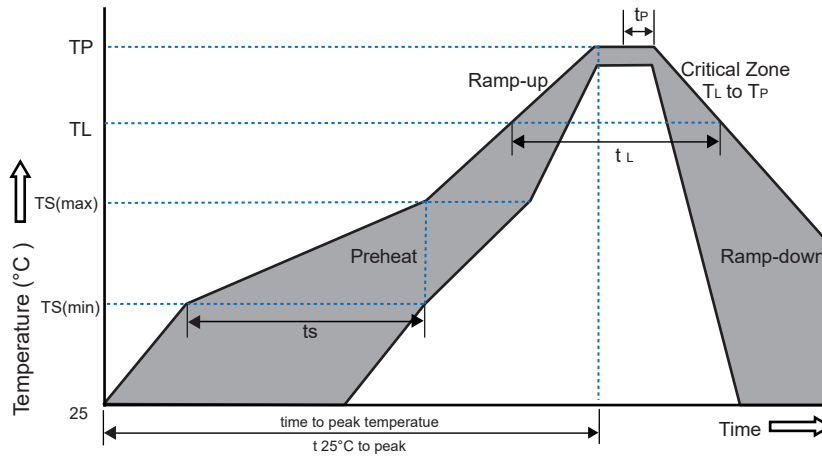

Reflow Condition		Pb-Free Assembly
Pre-heat	-Temperature Min( $T_{s(min)}$ )	+150°C
	-Temperature Max( $T_{s(max)}$ )	+200°C
	-Time(Min to Max)( $t_s$ )	60~180 secs.
Average ramp up rate (Liquid us Temp( $T_L$ ) to peak)		3°C/sec. Max
Ts(max) to $T_L$ - Ramp-up Rate		3°C/sec. Max
Reflow	-Temperature( $T_L$ )(Liquid us)	+217°C
	-Temperature ( $t_L$ )	60~150 secs.
Peak Temp ( $T_P$ )		+260(+0/-5)°C
Time within 5°C of actual Peak Temp ( $t_p$ )		30 secs. Max
Ramp-down Rate		6°C/sec. Max
xTime 25°C to Peak Temp (TP)		8 min. Max
Do not exceed		+260°C

### Part Number System

**JE N0603 - 5V - L C**

