

HLMP-AG74/75, HLMP-AM74/75, HLMP-AB74/75

Red, Green and Blue
5 mm Mini Oval LEDs



Data Sheet



Description

These Precision Optical Performance Oval LEDs are specifically designed for full color/video and passenger information signs. The oval shaped radiation pattern and high luminous intensity ensure that these devices are excellent for wide field of view outdoor applications where a wide viewing angle and readability in sunlight are essential. The package epoxy contains UV inhibitor to reduce the effects of long term exposure to direct sunlight.

Applications

- Full Color Signs
- Gas Price Signs

Features

- Well defined spatial radiation pattern
- High brightness material
- Available in red, green and blue color
 - Red AlInGaP 626 nm
 - Green InGaN 530 nm
 - Blue InGaN 470 nm
- Superior resistance to moisture
- Standoff and non-standoff Package
- Tinted and diffused
- Typical viewing angle 30° x 70°

Package Dimensions

Package Drawing A

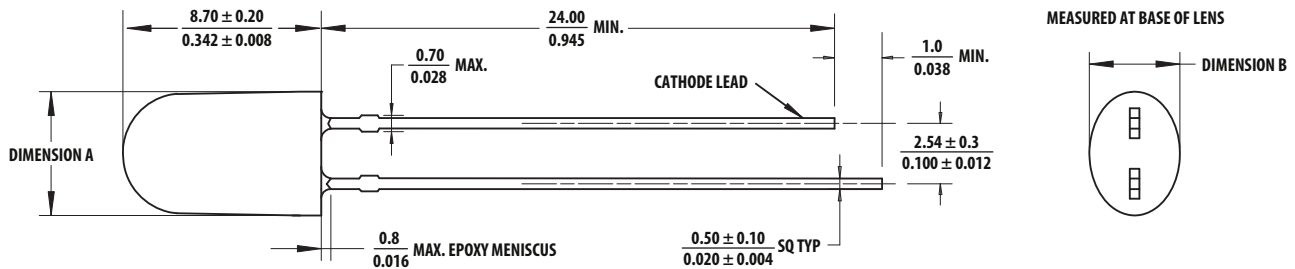

Package Drawing B

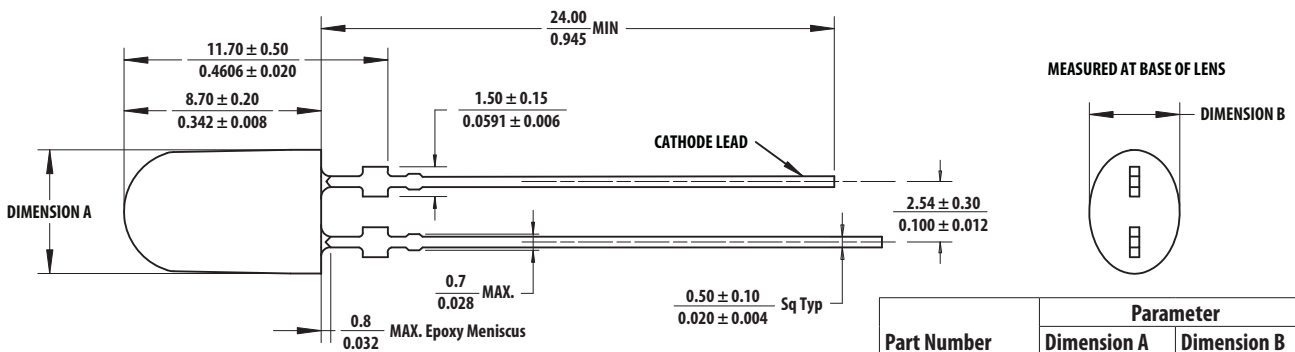

Notes:

All dimensions in millimeters (inches).

Tolerance is ± 0.20 mm unless other specified

Part Number	Parameter	
	Dimension A	Dimension B
HLMP-AG74/75	5.30 ± 0.20 0.209 ± 0.008	3.90 ± 0.20 0.154 ± 0.008
HLMP-AM74/75	5.40 ± 0.20	3.90 ± 0.20
HLMP-AB74/75	0.213 ± 0.008	0.150 ± 0.008

Caution: InGaN devices are Class 1C HBM ESD sensitive per JEDEC Standard. Please observe appropriate precautions during handling and processing. Refer to Application Note AN-1142 for additional details.

Device Selection Guide

Part Number	Color and Dominant Wavelength λ_d (nm) Typ ^[3]	Luminous Intensity I _v (mcd) at 20 mA ^[1,2,5]		Typical Viewing Angle (°) ^[4]	Standoff	Package Drawing
		Min	Max			
HLMP-AG74-120DD	Red 626	2900	4200	30° x 70°	No	A
HLMP-AG75-120DD	Red 626	2900	4200		Yes	B
HLMP-AM74-45CDD	Green 530	5040	7260	30° x 70°	No	A
HLMP-AM75-45CDD	Green 530	5040	7260		Yes	B
HLMP-AB74-WXBDD	Blue 470	1380	1990	30° x 70°	No	A
HLMP-AB75-WXBDD	Blue 470	1380	1990		Yes	B

Notes:

1. The luminous intensity is measured on the mechanical axis of the lamp package and it is tested with pulsing condition.
2. The optical axis is closely aligned with the package mechanical axis.
3. Dominant wavelength, λ_d , is derived from the CIE Chromaticity Diagram and represents the color of the lamp.
4. $\theta_{1/2}$ is the off-axis angle where the luminous intensity is half the on-axis intensity.
5. Tolerance for each bin limit is $\pm 15\%$.

Part Numbering System

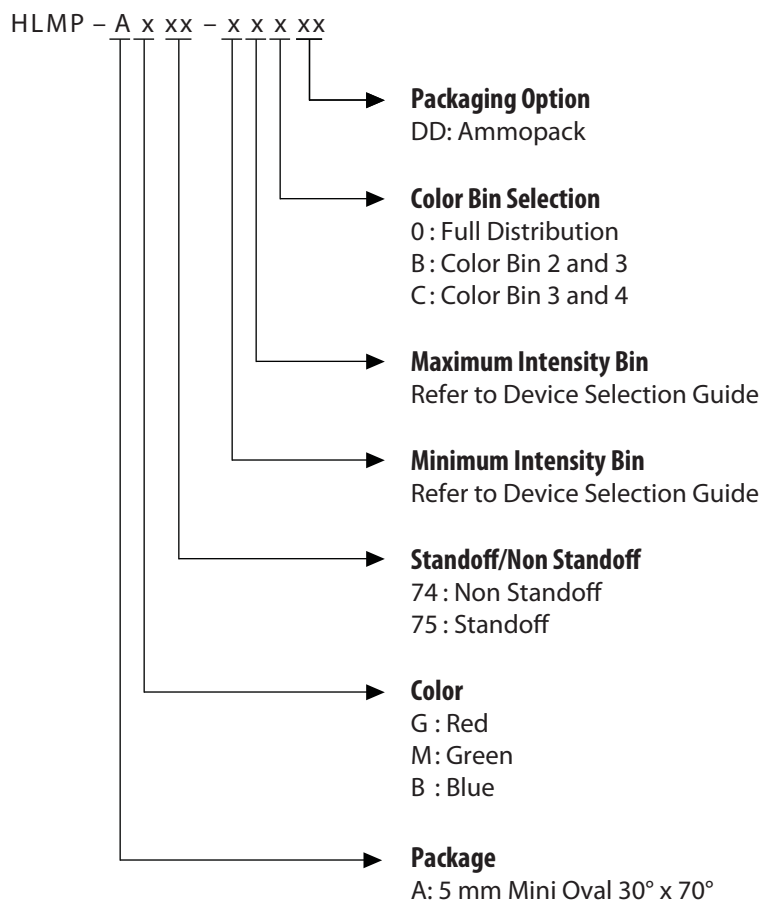

Note: Please refer to AB 5337 for complete information about part numbering system

Absolute Maximum Ratings

$T_J = 25^\circ\text{C}$

Parameter	Red	Green/ Blue	Unit
DC Forward Current ^[1]	50	30	mA
Peak Forward Current	100 ^[2]	100 ^[3]	mA
Power Dissipation	120	114	mW
LED Junction Temperature	130	110	$^\circ\text{C}$
Operating Temperature Range	-40 to +100	-40 to +85	$^\circ\text{C}$
Storage Temperature Range		-40 to +100	$^\circ\text{C}$

Notes:

1. Derate linearly as shown in Figures 4 and 8.
2. Duty Factor 30%, frequency 1 kHz.
2. Duty Factor 10%, frequency 1 kHz.

Electrical / Optical Characteristics

$T_J = 25^\circ\text{C}$

Parameter	Symbol	Min.	Typ.	Max.	Units	Test Conditions
Forward Voltage	V_F				V	$I_F = 20\text{ mA}$
Red		1.8	2.1	2.4		
Green		2.8	3.2	3.8		
Blue		2.8	3.2	3.8		
Reverse Voltage ^[3]	V_R				V	
Red		5				$I_R = 100\ \mu\text{A}$
Green and Blue		5				$I_R = 10\ \mu\text{A}$
Dominant Wavelength ^[1]	λ_d				nm	$I_F = 20\text{ mA}$
Red		618	626	630		
Green		527	530	535		
Blue		464	470	472		
Peak Wavelength	λ_{PEAK}				nm	Peak of Wavelength of Spectral Distribution at $I_F = 20\text{ mA}$
Red			634			
Green			521			
Blue			464			
Thermal Resistance	$R\theta_{J-PIN}$		240		$^\circ\text{C}/\text{W}$	LED Junction-to-Pin
Luminous Efficacy ^[2]	η_V				lm/W	Emitted Luminous Power/ Emitted Radiant Power
Red			218			
Green			538			
Blue			65			

Notes:

1. The dominant wavelength is derived from the chromaticity Diagram and represents the color of the lamp.
2. The radiant intensity, I_e in watts per steradian, may be found from the equation $I_e = I_V/\eta_V$ where I_V is the luminous intensity in candelas and η_V is the luminous efficacy in lumens/watt.
3. Indicates product final testing condition. Long term reverse bias is not recommended.

AlInGaP Red

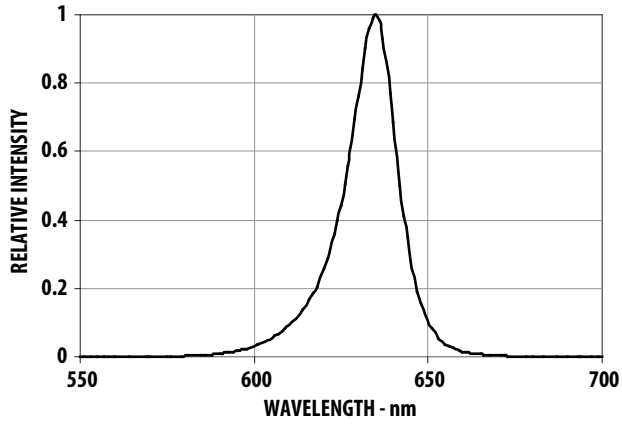

Figure 1. Relative Intensity vs Wavelength

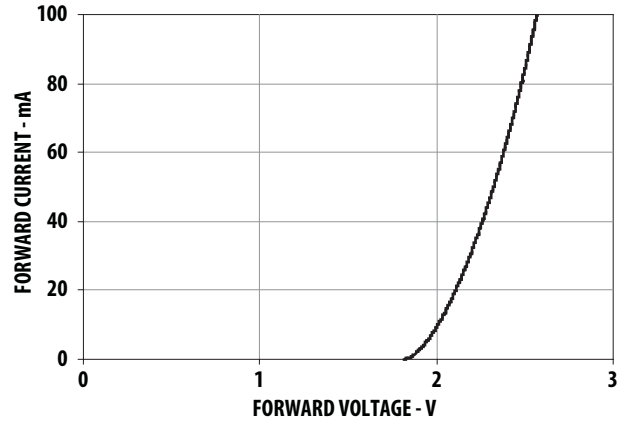

Figure 2. Forward Current vs Forward Voltage

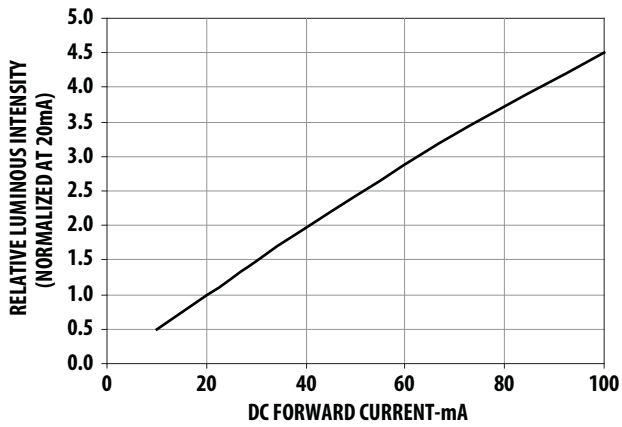

Figure 3. Relative Intensity vs Forward Current

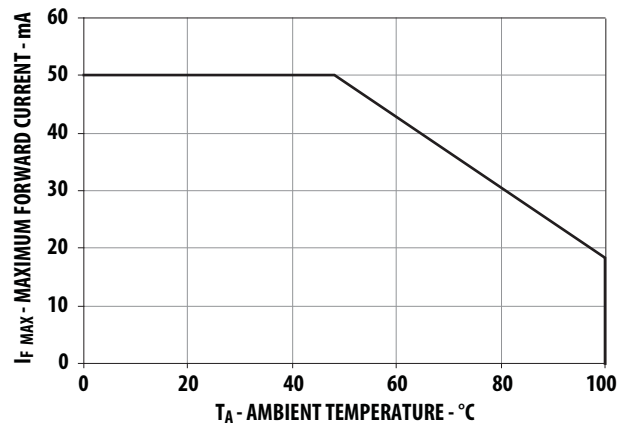

Figure 4. Maximum Forward Current vs Ambient Temperature

InGaN Green and Blue

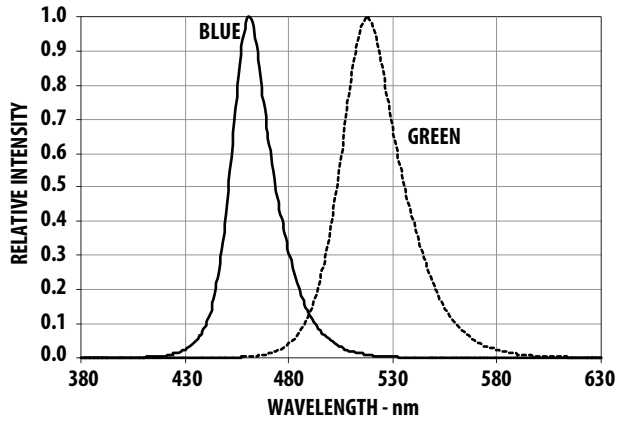

Figure 5. Relative Intensity vs Wavelength

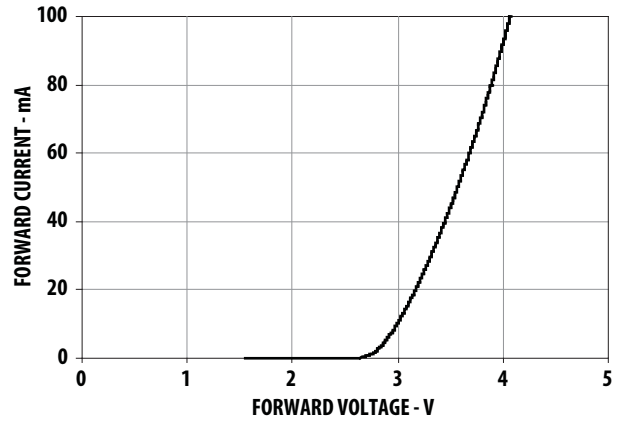

Figure 6. Forward Current vs Forward Voltage

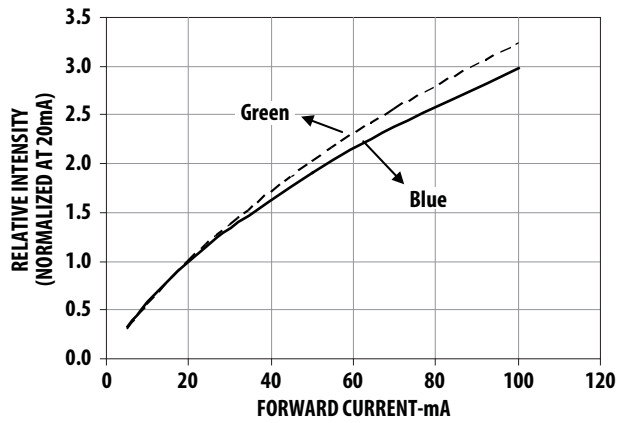

Figure 7. Relative Intensity vs Forward Current

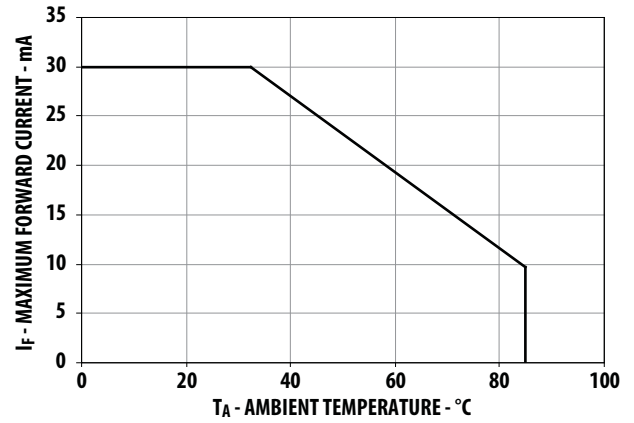

Figure 8. Maximum Forward Current vs Ambient Temperature

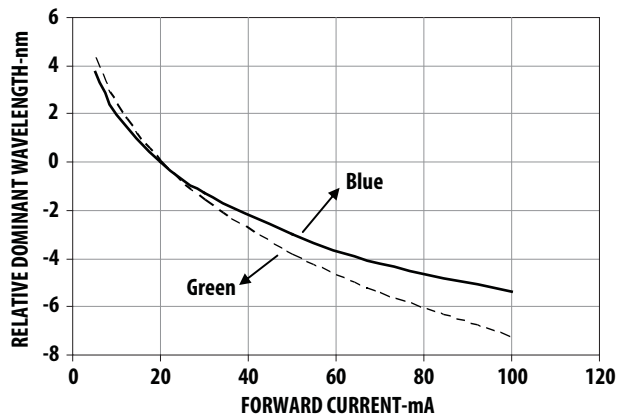

Figure 9. Relative Dominant Wavelength vs Forward Current

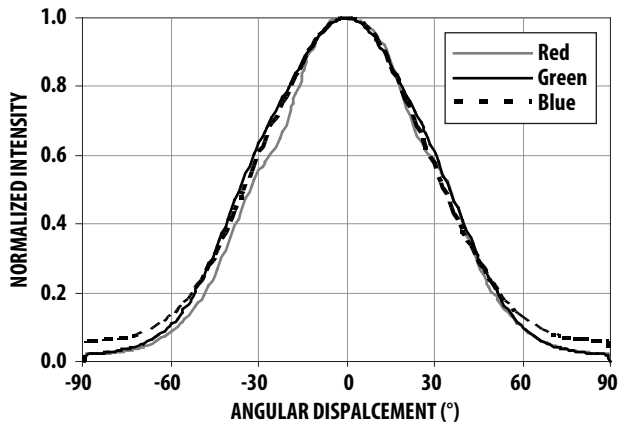

Figure 10. Radiation pattern-Major Axis

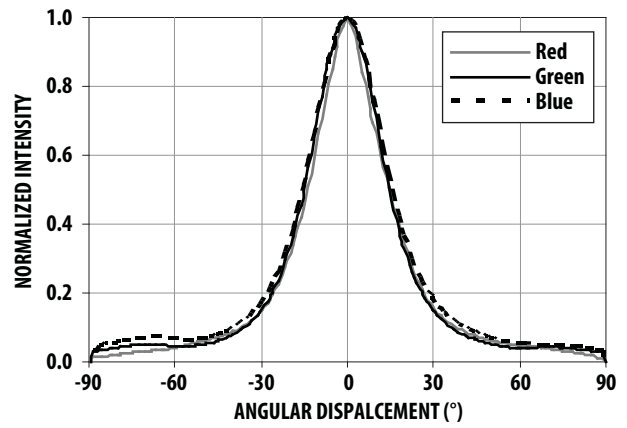

Figure 11. Radiation pattern-Minor Axis

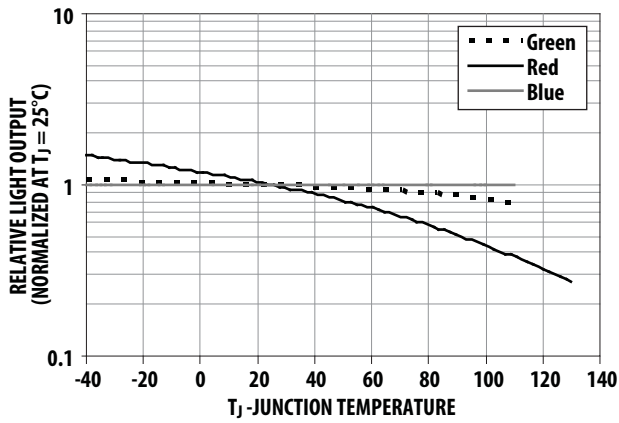

Figure 12. Relative Light Output vs Junction Temperature

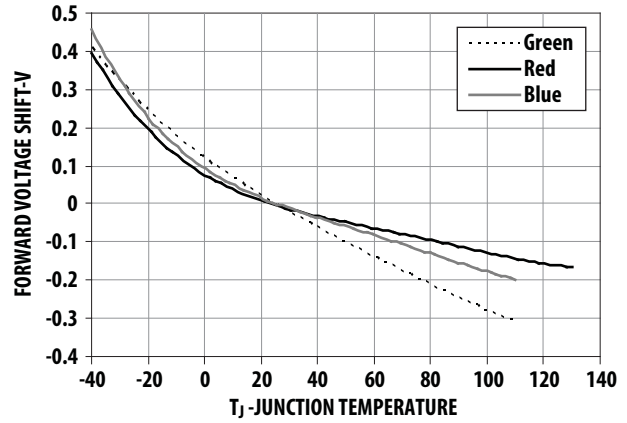

Figure 13. Forward Voltage Shift vs Junction Temperature

Intensity Bin Limit Table (1.2: 1 Iv Bin Ratio)

Bin	Intensity (mcd) at 20 mA	
	Min	Max
W	1380	1660
X	1660	1990
Y	1990	2400
Z	2400	2900
1	2900	3500
2	3500	4200
3	4200	5040
4	5040	6050
5	6050	7260

Tolerance for each bin limit is $\pm 15\%$

V_f Bin Table (V at 20 mA)

Bin ID	Min	Max
VD	1.8	2.0
VA	2.0	2.2
VB	2.2	2.4

Notes:

1. Tolerance for each bin limit is ± 0.05 V
2. V_f binning only applicable to Red color.

Red Color Range

Min	Max					
Dom	Dom	x	y	z	x	y
618.0	630.0	0.6872	0.3126	0.6890	0.2943	
		0.6690	0.3149	0.7080	0.2920	

Tolerance for each bin limit is ± 0.5 nm

Green Color Bin Table

Bin	Min Dom	Max Dom	x	y	z	x	y
3	527	531	0.1305	0.1711	0.1967	0.1625	
			0.8189	0.7218	0.7077	0.8012	
4	531	535	0.1625	0.1967	0.221	0.1929	
			0.8012	0.7077	0.692	0.7816	

Tolerance for each bin limit is ± 0.5 nm

Blue Color Bin Table

Bin	Min Dom	Max Dom	x	y	z	x	y
2	464	468	0.1374	0.1766	0.1699	0.1291	
			0.0374	0.0966	0.1062	0.0495	
3	468	472	0.1291	0.1699	0.1616	0.1187	
			0.0495	0.1062	0.1209	0.0671	

Tolerance for each bin limit is ± 0.5 nm

Note:

- All bin categories are established for classification of products. Products may not be available in all bin categories. Please contact your Avago representative for further information.

Avago Color Bin on CIE 1931 Chromaticity Diagram

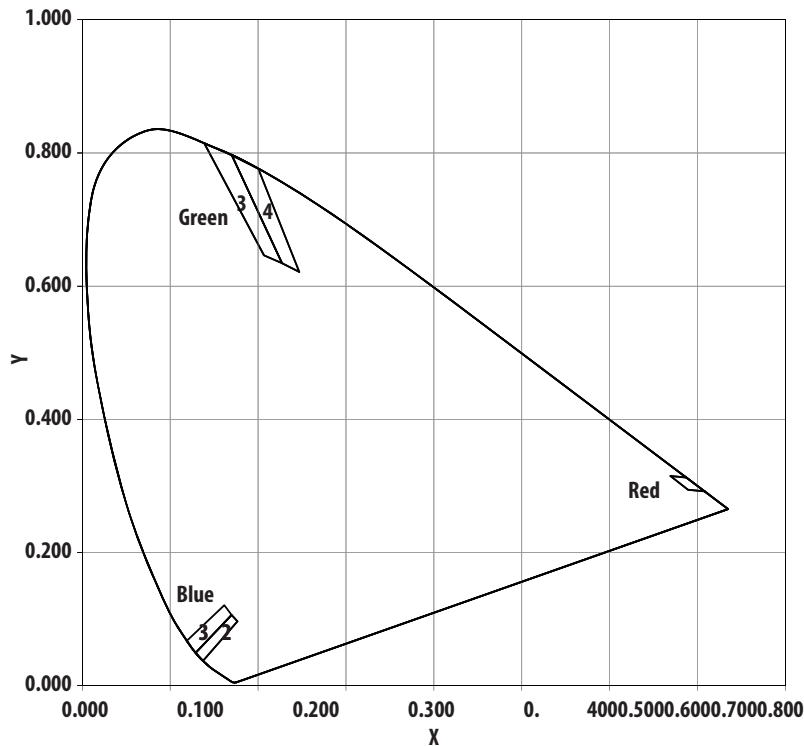

Precautions:

Lead Forming:

- The leads of an LED lamp may be preformed or cut to length prior to insertion and soldering on PC board.
- For better control, it is recommended to use proper tool to precisely form and cut the leads to applicable length rather than doing it manually.
- If manual lead cutting is necessary, cut the leads after the soldering process. The solder connection forms a mechanical ground which prevents mechanical stress due to lead cutting from traveling into LED package. This is highly recommended for hand solder operation, as the excess lead length also acts as small heat sink.

Soldering and Handling:

- Care must be taken during PCB assembly and soldering process to prevent damage to the LED component.
- LED component may be effectively hand soldered to PCB. However, it is only recommended under unavoidable circumstances such as rework. The closest manual soldering distance of the soldering heat source (soldering iron's tip) to the body is 1.59 mm. Soldering the LED using soldering iron tip closer than 1.59 mm might damage the LED.

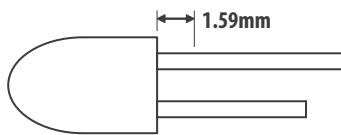

- ESD precaution must be properly applied on the soldering station and personnel to prevent ESD damage to the LED component that is ESD sensitive. Do refer to Avago application note AN 1142 for details. The soldering iron used should have grounded tip to ensure electrostatic charge is properly grounded.
- Recommended soldering condition:

	Wave Soldering [1, 2]	Manual Solder Dipping
Pre-heat temperature	105° C Max.	–
Preheat time	60 sec Max	–
Peak temperature	260° C Max.	260° C Max.
Dwell time	5 sec Max.	5 sec Max

Note:

1. Above conditions refers to measurement with thermocouple mounted at the bottom of PCB.
 2. It is recommended to use only bottom preheaters in order to reduce thermal stress experienced by LED.
- Wave soldering parameters must be set and maintained according to the recommended temperature and dwell time. Customer is advised to perform daily check on the soldering profile to ensure that it is always conforming to recommended soldering conditions.

Note:

1. PCB with different size and design (component density) will have different heat mass (heat capacity). This might cause a change in temperature experienced by the board if same wave soldering setting is used. So, it is recommended to re-calibrate the soldering profile again before loading a new type of PCB.
2. Avago Technologies' AllnGaP high brightness LED are using high efficiency LED die with single wire bond as shown below. Customer is advised to take extra precaution during wave soldering to ensure that the maximum wave temperature does not exceed 260° C and the solder contact time does not exceeding 5 sec. Over-stressing the LED during soldering process might cause premature failure to the LED due to delamination.

Avago Technologies LED configuration

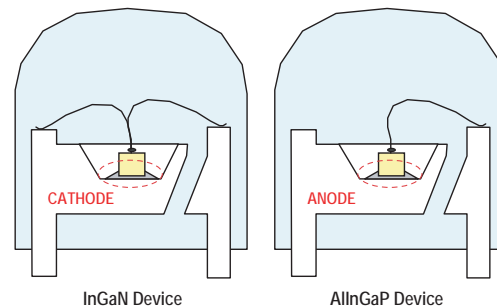

- Any alignment fixture that is being applied during wave soldering should be loosely fitted and should not apply weight or force on LED. Non metal material is recommended as it will absorb less heat during wave soldering process.
- At elevated temperature, LED is more susceptible to mechanical stress. Therefore, PCB must allowed to cool down to room temperature prior to handling, which includes removal of alignment fixture or pallet.
- If PCB board contains both through hole (TH) LED and other surface mount components, it is recommended that surface mount components be soldered on the top side of the PCB. If surface mount need to be on the bottom side, these components should be soldered using reflow soldering prior to insertion the TH LED.
- Recommended PC board plated through holes (PTH) size for LED component leads.

LED component lead size	Diagonal	Plated through hole diameter
0.45 x 0.45 mm (0.018x 0.018 inch)	0.636 mm (0.025 inch)	0.98 to 1.08 mm (0.039 to 0.043 inch)
0.50 x 0.50 mm (0.020x 0.020 inch)	0.707 mm (0.028 inch)	1.05 to 1.15 mm (0.041 to 0.045 inch)

- Over-sizing the PTH can lead to twisted LED after clinching. On the other hand under sizing the PTH can cause difficulty inserting the TH LED.

Refer to application note AN5334 for more information about soldering and handling of high brightness TH LED lamps.

Example of Wave Soldering Temperature Profile for TH LED

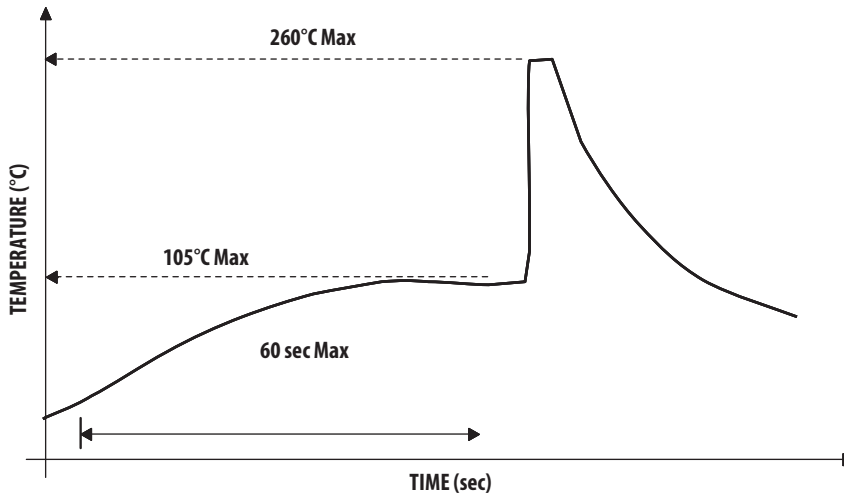

Recommended solder:
 Sn63 (Leaded solder alloy)
 SAC305 (Lead free solder alloy)

Flux: Rosin flux

Solder bath temperature: 255°C ± 5°C
 (maximum peak temperature = 260°C)

Dwell time: 3.0 sec - 5.0 sec
 (maximum = 5sec)

Note: Allow for board to be sufficiently cooled to room temperature before exerting mechanical force.

Ammo Packs Drawing

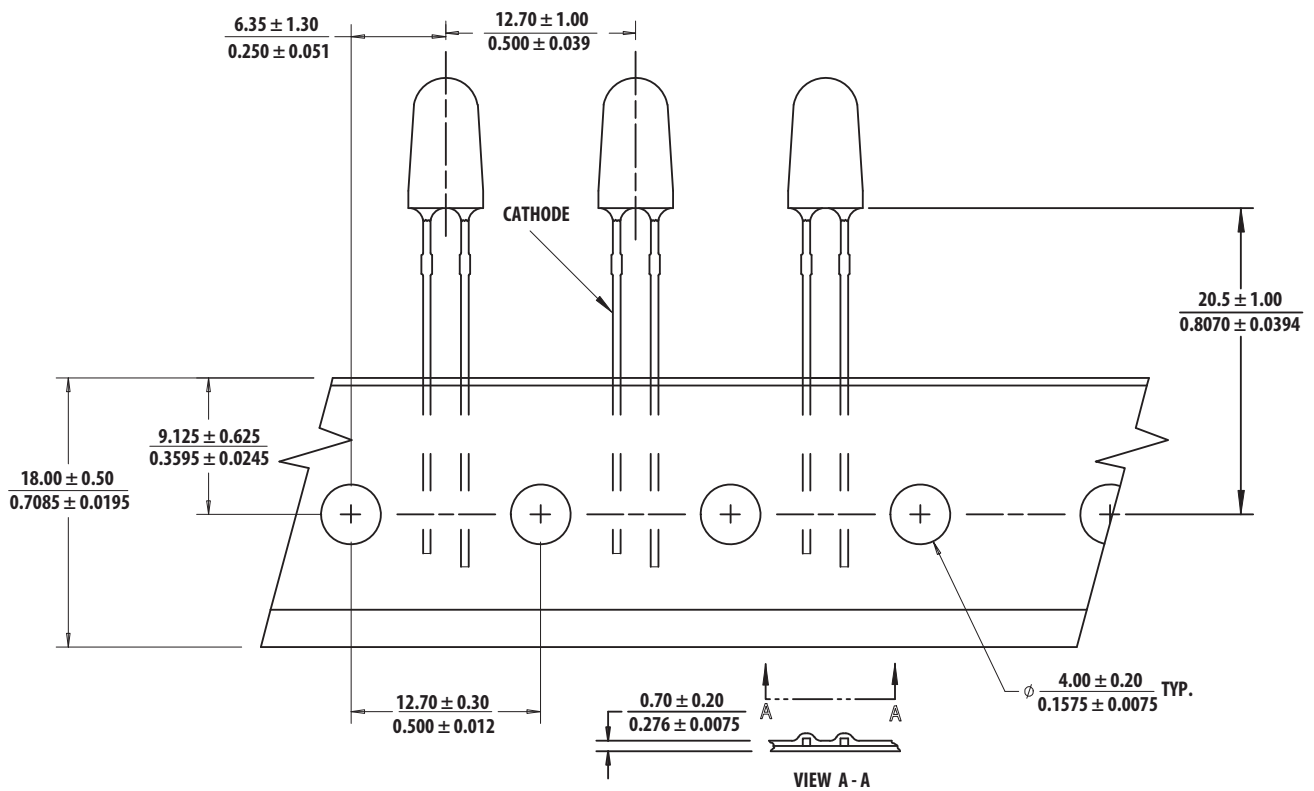

Note: All dimensions in millimeters (inches)

Packaging Box for Ammo Packs

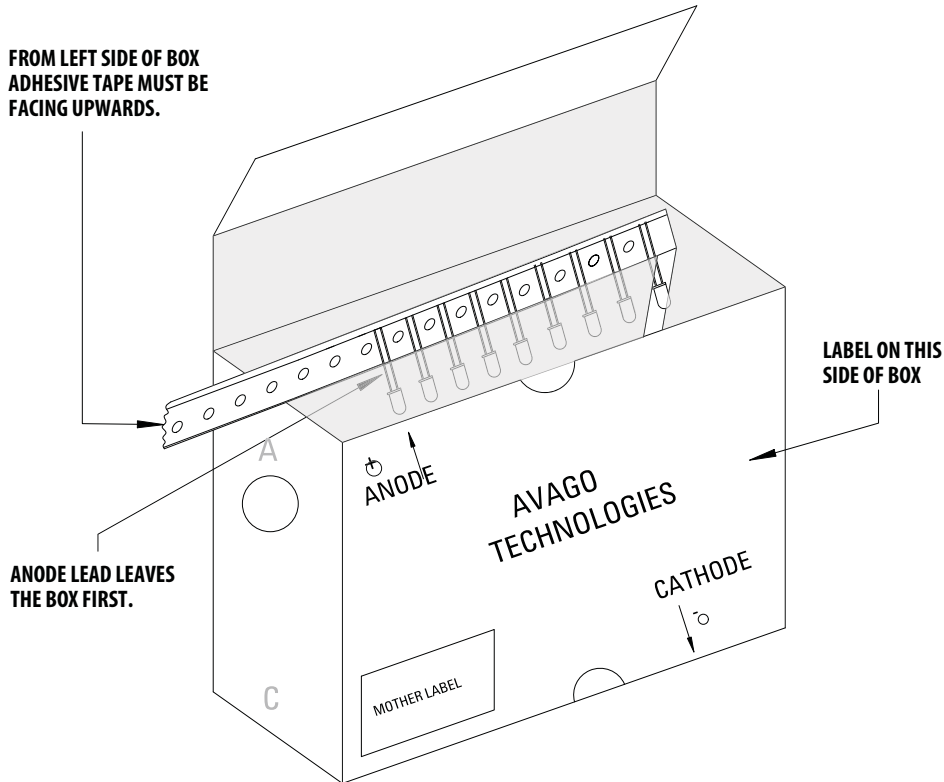

Note: For InGaN device, the ammo pack packaging box contain ESD logo

Packaging Label

(i) Avago Mother Label: (Available on packaging box of ammo pack and shipping box)

AVAGO TECHNOLOGIES	
STANDARD LABEL LS0002 RoHS Compliant e3 max temp 260C	
(1P) Item: Part Number [Barcode]	(Q) QTY: Quantity [Barcode]
(1T) Lot: Lot Number [Barcode]	CAT: Intensity Bin [Barcode]
LPN: [Barcode]	BIN: Refer to below information
(9D)MFG Date: Manufacturing Date [Barcode]	
(P) Customer Item: [Barcode]	
(V) Vendor ID: [Barcode]	(9D) Date Code: Date Code [Barcode]
DeptID: [Barcode]	Made In: Country of Origin [Barcode]

(ii) Avago Baby Label (Only available on bulk packaging)

AVAGO TECHNOLOGIES		RoHS Compliant e3 max temp 260C	
Lamps Baby Label			
(1P) PART #: Part Number			
(1T) LOT #: Lot Number			
(9D)MFG DATE: Manufacturing Date	QUANTITY: Packing Quantity		
C/O: Country of Origin			
Customer P/N:	CAT: Intensity Bin		
Supplier Code:	BIN: Refer to below information		
	DATECODE: Date Code		

Acronyms and Definition:

BIN:

(i) Color bin only or VF bin only (Applicable for part number with color bins but without VF bin OR part number with VF bins and no color bin)

OR

(ii) Color bin incorporated with VF Bin (Applicable for part number that have both color bin and VF bin)

Example:

(i) Color bin only or VF bin only

BIN: 2 (represent color bin 2 only)

BIN: VB (represent VF bin "VB" only)

(ii) Color bin incorporate with VF Bin

BIN: 2 VB

└─┬─┬─> VB: VF bin "VB"

└─┬─┬─> 2: Color bin 2 only

DISCLAIMER: Avago's products and software are not specifically designed, manufactured or authorized for sale as parts, components or assemblies for the planning, construction, maintenace or direct operation of a nuclear facility or for use in medical devices or applications. Customer is solely responsible, and waives all rights to make claims against avago or its suppliers, for all loss, damage, expense or liability in connection with such use.

For product information and a complete list of distributors, please go to our web site: www.avagotech.com

Avago, Avago Technologies, and the A logo are trademarks of Avago Technologies in the United States and other countries. Data subject to change. Copyright © 2005-2011 Avago Technologies. All rights reserved. AV02-2753EN - April 21, 2011

