

03

0315-1 U

Circular connectors with threaded joint M16 acc. to IEC 61076-2-106, IP40/IP67/IP68



Chassis plug acc. to IEC 61076-2-106 and AISG specification, IP 68, with threaded joint, cables and potted solder area, for back side mounting

03

0315-1 U

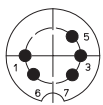
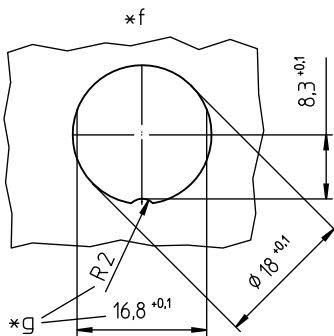
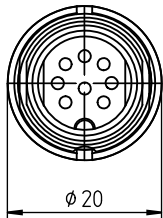
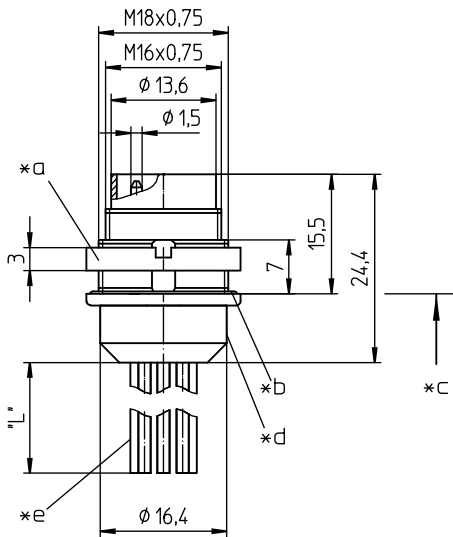

*h

0315-1 05-3 U

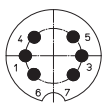

-

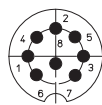

08-a

0315-1 08-1 U

Environmental conditions

Temperature range -40 °C/+85 °C

Materials

Insulating body	PA GF, V-0 according to UL94
Contact pin	CuZn, silver-plated and flash gold-plated
Housing	Zn diecast, pre-copper and nickel-plated
Ring screw	CuZn, nickel-plated
Potting	TPU, V-0 according to UL94
Seal	NBR

Mechanical data

Protection class IP68¹

¹ according to IEC DIN EN 60529, only in locked condition with an appropriate counterpart; IPX8 requirements under agreement between manufacturer and user

Connected cable







Construction	stranded wire, 7 x $\phi 0.26$ mm
Section	0,34 mm ² (AWG 22)

Electrical data (at T_{amb} 20 °C)





Rated current	5 A (T _{amb} 40 °C)
Rated voltage	100 V (with pollution degree 1) 32 V (with pollution degree 2)
Rated impulse voltage	500 V
Material group	II (IEC)/1 (UL) (CTI \geq 550)
Overtoltage category	I
Insulation resistance	> 100 M Ω

Associated products

Counterparts

 0321	 0322	 0322-1
 032200	 0360	 036000

Accessories

 0383	 038399	 0384
 0385	 038899	

03

0315-1 U

Color assignment of the cables

1	violett	violet
2	rot	red
3	grün	green
4	weiß	white
5	schwarz	black
6	grau	grey
7	blau	blue
8	braun	brown

- *a nut enclosed separately
- *b O-ring gasket
- *c mounting direction
- *d solder area potted
- *e stranded wire 0.34 mm² (AWG 22), 7 x Ø 0.26 mm
- *f port in mounting plate
- *g anti-rotation, alternative execution
- *h pin configuration according to AISG C485

03

0315-1 U

Designation	Pole Number	PU (Pieces)	MDQ (Pieces)	Dimensions L (mm)
0315-1 05-3 U	5	50	100	-
0315-1 08-1 U	8	50	100	140

Packaging:

in a cardboard box