

POWER TRANSFORMER

DCS3-40 (F) SERIES

1. CONFIGURATION & DIMENSIONS :

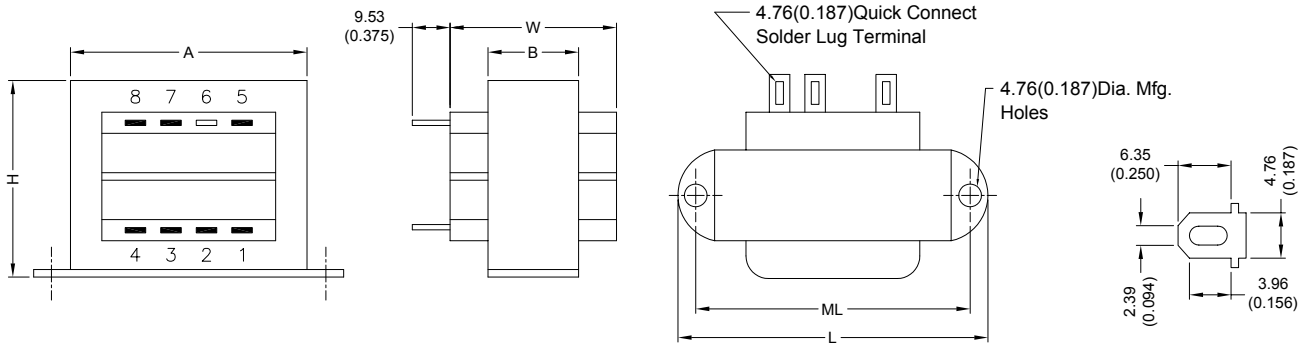

UNIT : mm (inch)

SIZE	VA	L	W	H	A	B	ML	gram
3	2.4	52.40 (2.063)	27.00 (1.063)	30.18 (1.188)	41.28 (1.625)	14.30 (0.563)	44.45 (1.75)	113.40

2. SCHEMATIC :

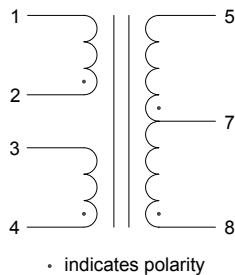

3. ELECTRICAL CHARACTERISTICS (@ 25°C) :

- | | |
|--------------------------------------|------------------------------|
| a. Primary Voltage | AC 115/230 V 50/60 Hz . |
| b. No Load Primary Current | Less Than 10mA / 15mA . |
| c. Secondary Voltage (±5%) | |
| Pin 5-8 C.T. Pin 7 | AC 49.20 V / 49.20 V . |
| d. Secondary Load Current | 0.06A . |
| e. Full Load Primary Current | Less Than 40mA / 25mA . |
| f. Full Load Secondary Voltage (±5%) | 40.00V / 40.00V . |
| Pin 5-8 C.T. Pin 7 | |
| g. DC Resistance | |
| Pin 1-2 | Primary-1 = 575 Ohm . |
| Pin 3-4 | Primary-2 = 750 Ohm . |
| Pin 5-7 | Secondary-1 = - Ohm . |
| Pin 7-8 | Secondary-2 = - Ohm . |
| h. Insulation Resistance | DC 500V 100Meg Ohm Of More . |
| i. Withstand Voltage (Hi-Pot) | AC 2500V 60Hz 1 Minutes . |
| j. Temperature Rise | Less Than 60 Deg C . |
| k. Core Size | EI-35 x 13.00 m/m . |

l. Turns & Wire Gauge

Primary-1	Pin 1-2	2660	Turns Diameter	0.08 mm
Primary-2	Pin 3-4	2660	Turns Diameter	0.08 mm
Secondary	Pin 5-7-8	572 x 2	Turns Diameter	0.14 mm



RoHS Compliant

NOTE : Specifications subject to change without notice. Please check our website for latest information.

25.02.2008



SUPERWORLD ELECTRONICS (S) PTE LTD

PG. 1