

LED..S50L.. High-Intensity Spot Light



Datasheet

For use with PresencePLUS and other vision systems

For the latest technical information about this product, including specifications, dimensions, and wiring, see www.bannerengineering.com.

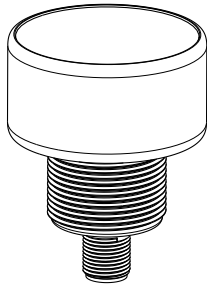

- Low-cost, washdown spot light for vision systems
- Continuous or strobed operation, depending on wiring
- Selectable Active High or Active Low strobe option, depending on wiring
- Optically isolated strobe signal
- Three lens options, depending on model, to vary spot size
- Illuminates a large area with an even pattern of light and no shadows
- 12 to 30V dc operation
- Cabled and quick-disconnect models available
- 50 mm diameter with flat profile and 30 mm mounting base
- Rugged sealed housing rated to IP69K

Models

Model ¹	LED Color	Lumens / mWatts	Lux / mW/cm ²		Lens Angle	Connection
			0.5 m	1 m		
LEDWS50L5-XQ	White, 5000-8300 K	295 lm	13780 lx	3445 lx	±5° (smaller, more focused spot; see graph)	5 pin Euro integral QD connector (use with 5-wire mating cordset)
LEDRS50L5-XQ	Red, 620-630 nm	110 lm	8000 lx	2000 lx		
LEDBS50L5-XQ	Blue, 465-485 nm	85 lm	4880 lx	1220 lx		
LEDGS50L5-XQ	Green, 520-535 nm	210 lm	13000 lx	3250 lx		
LEDIS50L5-XQ	Infrared, 850 nm	760 mW	4.40 mW/cm ²	1.10 mW/cm ²		
LEDUV395S50L5-XQ	Ultraviolet, 395 nm	480 mW	2.10 mW/cm ²	.525 mW/cm ²		
LEDWS50L11-XQ	White, 5000-8300 K	285 lm	5460 lx	1365 lx	±11° (larger spot; see graph)	
LEDRS50L11-XQ	Red, 620-630 nm	105 lm	2500 lx	625 lx		
LEDBS50L11-XQ	Blue, 465-485 nm	80 lm	1540 lx	385 lx		
LEDGS50L11-XQ	Green, 520-535 nm	200 lm	3900 lx	975 lx		
LEDUV395S50L11-XQ	Ultraviolet, 395 nm	420 mW	.780 mW/cm ²	.195 mW/cm ²		
LEDIS50L14-XQ	Infrared, 850 nm	665 mW	1.16 mW/cm ²	.290 mW/cm ²	±14° (larger spot; see graph)	
LEDWS50L20-XQ	White, 5000-8300 K	270 lm	2000 lx	500 lx	±20° (largest spot; see graph)	
LEDRS50L20-XQ	Red, 620-630 nm	100 lm	1040 lx	260 lx		
LEDBS50L20-XQ	Blue, 465-485 nm	75 lm	700 lx	175 lx		
LEDGS50L20-XQ	Green, 520-535 nm	190 lm	1700 lx	425 lx		
LEDUV395S50L20-XQ	Ultraviolet, 395 nm	390 mW	.420 mW/cm ²	.105 mW/cm ²		

¹ Integral QD models only are listed. For integral 2 m (6.5'ft) PVC cable, omit suffix XQ from model number (example, LEDRS50L5). A model with a QD requires a mating cordset (see [5-Pin Euro-Style Cordsets](#) on page 4).



The following caution applies to blue LED models:



CAUTION:

Risk Group 2: Possibly hazardous optical radiation emitted from this product.

Do not stare at the operating lamp. May be harmful to the eyes. Risk Group 2 (RG 2) products generally do not pose a realistic optical hazard if aversion responses limit the exposure duration or where lengthy exposures are unrealistic.

- IEC 62471

The following caution applies to ultraviolet models:



CAUTION:

Risk Group 2: UV Emitted from this product.

Eye or skin irritation may result from exposure. Use appropriate shielding and eye protection. Risk Group 2 (RG 2) products generally do not pose a realistic optical hazard if aversion responses limit the exposure duration or where lengthy exposures are unrealistic.

- IEC 62471

The following caution applies to LEDIS50L5-xx infrared models:



CAUTION:

Risk Group 1: IR Emitted from this product.

Use appropriate shielding or eye protection. Risk Group 1 (RG 1) products are safe for most use applications, except for very prolonged exposures where direct ocular exposures may be expected.

- IEC 62471

Specifications

Supply Voltage and Current

Operating voltage: 12 to 30V dc
Strobe voltage: 5 to 30V dc @ 15 mA max.
Current draw: 400 mA at 12V, 160 mA at 30V

Supply Protection Circuitry

Protected against reverse polarity and transient voltages

Light Source

Three high-intensity LEDs; see models table for color temperature or wavelengths

Strobe

Optically isolated, 40kHz max strobe frequency
5 μ s minimum on time

Useful Life

When operating within specifications, output will decrease less than 30% after 50,000 hours for visible and IR models; 20,000 hours for UV models.

Construction

Black anodized aluminum housing; acrylic window; nickel-plated QD connector or PVC-jacketed cable; black zinc-plated steel mounting nut

Mounting:

30x1.5 mm thread base mount

Environmental Rating

IEC IP67, IP69K per DIN 40050-9



NOTE: Do not spray the cable with a high-pressure sprayer or cable damage will result.

Connections

Integral 5-pin M12/Euro style QD or 2 m (6.5 ft) integral cable, depending on model; 5-pin connecting cordset required for QD models

Operating Conditions

-20 °C to +50 °C (-4 °F to +122 °F)
95% maximum relative humidity (non-condensing)

Vibration and Mechanical Shock

All models meet Mil. Std. 202F requirements method 201A (vibration: 10 to 60 Hz max., double amplitude 0.06", maximum acceleration 10G). Also meets IEC 947-5-2; 30G 11 ms duration, half sine wave.

Storage Temperature

-40 °C to +70 °C (-40 °F to +158 °F)

Certifications



Beam Patterns

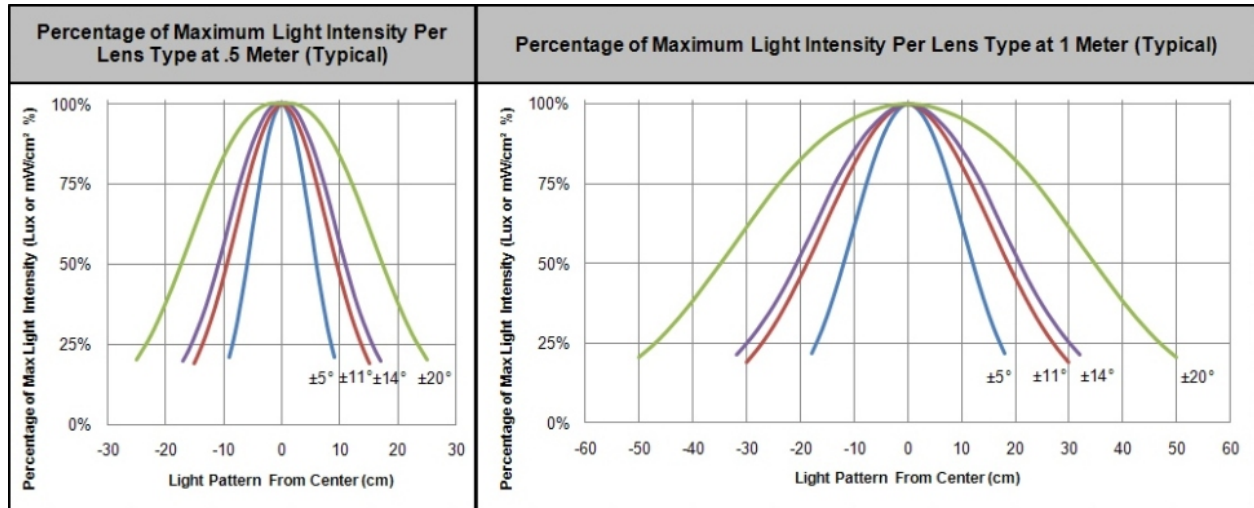

Dimensions

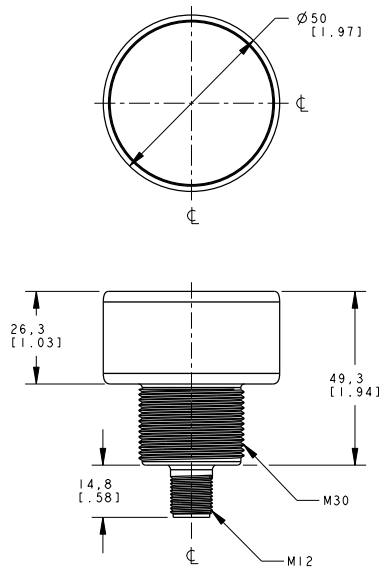

Wiring Table

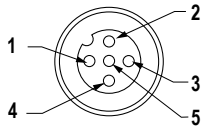
Wire Purpose	Cable Wire Color ²	Continuous On Mode	Strobed Mode	PresencePlus Pro Controller Terminal Block
Power Wires	Brown (1)	+12-30V dc	+12-30V dc	Pin 01 ³
	Blue (3)	common	common	Pin 02
Strobe Polarity Control	Gray (5)	open	Active Low: open	Open — Active Low
			Active High: connect to common (Blue wire)	Pin 02 — Active High
Strobe Voltage Wires	White (2)	open	0V dc = ON (Active Low) +5 to 30V dc = OFF (Active Low)	Pin 04
			0V dc = OFF (Active High) +5 to 30V dc = ON (Active High)	
	Black (4)	open	Strobe common	Pin 02
 <p>Figure 1. Pinout for Mating Cordset</p>			<p>Wiring Key</p> <p>1 = +12-30V dc 2 = Strobe (+) 3 = Common 4 = Strobe common 5 = Active high / Active Low</p>	

5-Pin Euro-Style Cordsets

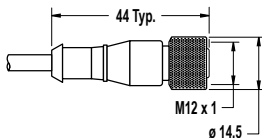
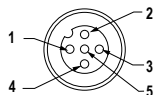
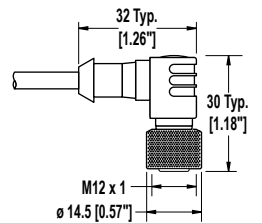
5-Pin Threaded M12/Euro-Style Cordsets (Single Ended)				
Model	Length	Style	Dimensions	Pinout (Female)
MQDC1-501.5	0.50 m (1.5 ft)	Straight		 <p>1 = Brown 2 = White 3 = Blue 4 = Black 5 = Gray</p>
MQDC1-506	1.83 m (6 ft)			
MQDC1-515	4.57 m (15 ft)			
MQDC1-530	9.14 m (30 ft)			
MQDC1-506RA	1.83 m (6 ft)	Right-Angle		
MQDC1-515RA	4.57 m (15 ft)			
MQDC1-530RA	9.14 m (30 ft)			

² For Banner-supplied wire.

³ When connecting the light to a PresencePLUS Pro controller terminal block, the controller supply must be 24V dc \pm 10%.

Mounting Brackets

All measurements are in mm

SMB30A

- Right-angle bracket with curved slot for versatile orientation
- Clearance for M6 (1/4 in) hardware
- Mounting hole for 30 mm sensor
- 12-ga. stainless steel

Hole center spacing: A to B=40
Hole size: A=ø 6.3, B= 27.1 x 6.3, C=ø 30.5

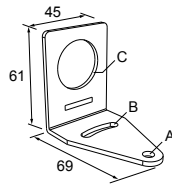

SMB30SC

- Swivel bracket with 30 mm mounting hole for sensor
- Black reinforced thermoplastic polyester
- Stainless steel mounting and swivel locking hardware included

Hole center spacing: A=ø 50.8
Hole size: A=ø 7.0, B=ø 30.0

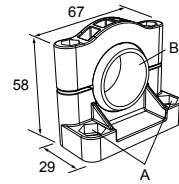

SMB30FA

- Swivel bracket with tilt and pan movement for precise adjustment
- Mounting hole for 30 mm sensor
- 12-ga. 304 stainless steel
- Easy sensor mounting to extrude rail T-slot
- Metric and inch size bolt available

Bolt thread: SMB30FA, A= 3/8 - 16 x 2 in; SMB30FAM10, A= M10 - 1.5 x 50
Hole size: B= ø 30.1

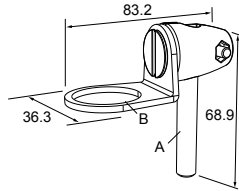

SMBAMS30P

- Flat SMBAMS series bracket
- 30 mm hole for mounting sensors
- Articulation slots for 90° + rotation
- 12-ga. 300 series stainless steel

Hole center spacing: A=26.0, A to B=13.0
Hole size: A=26.8 x 7.0, B=ø 6.5, C=ø 31.0

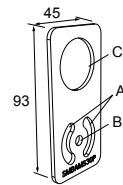

SMB30MM

- 12-ga. stainless steel bracket with curved mounting slots for versatile orientation
- Clearance for M6 (1/4 in) hardware
- Mounting hole for 30 mm sensor

Hole center spacing: A = 51, A to B = 25.4
Hole size: A = 42.6 x 7, B = ø 6.4, C = ø 30.1

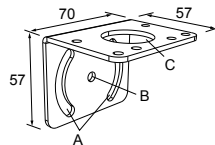

SMBAMS30RA

- Right-angle SMBAMS series bracket
- 30 mm hole for mounting sensors
- Articulation slots for 90° + rotation
- 12-ga. (2.6 mm) cold-rolled steel

Hole center spacing: A=26.0, A to B=13.0
Hole size: A=26.8 x 7.0, B=ø 6.5, C=ø 31.0

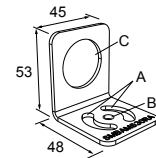

Banner Engineering Corp Limited Warranty

Banner Engineering Corp. warrants its products to be free from defects in material and workmanship for one year following the date of shipment. Banner Engineering Corp. will repair or replace, free of charge, any product of its manufacture which, at the time it is returned to the factory, is found to have been defective during the warranty period. This warranty does not cover damage or liability for misuse, abuse, or the improper application or installation of the Banner product.

THIS LIMITED WARRANTY IS EXCLUSIVE AND IN LIEU OF ALL OTHER WARRANTIES WHETHER EXPRESS OR IMPLIED (INCLUDING, WITHOUT LIMITATION, ANY WARRANTY OF MERCHANTABILITY OR FITNESS FOR A PARTICULAR PURPOSE), AND WHETHER ARISING UNDER COURSE OF PERFORMANCE, COURSE OF DEALING OR TRADE USAGE.

This Warranty is exclusive and limited to repair or, at the discretion of Banner Engineering Corp., replacement. IN NO EVENT SHALL BANNER ENGINEERING CORP. BE LIABLE TO BUYER OR ANY OTHER PERSON OR ENTITY FOR ANY EXTRA COSTS, EXPENSES, LOSSES, LOSS OF PROFITS, OR ANY INCIDENTAL, CONSEQUENTIAL OR

SPECIAL DAMAGES RESULTING FROM ANY PRODUCT DEFECT OR FROM THE USE OR INABILITY TO USE THE PRODUCT, WHETHER ARISING IN CONTRACT OR WARRANTY, STATUTE, TORT, STRICT LIABILITY, NEGLIGENCE, OR OTHERWISE.

Banner Engineering Corp. reserves the right to change, modify or improve the design of the product without assuming any obligations or liabilities relating to any product previously manufactured by Banner Engineering Corp.