

Data sheet | Item number: 787-783/000-040

Redundancy Module; 2 x 9 ... 54 VDC input voltage; 2 x 12.5 A input current;
9–54 VDC output voltage; 25 A output current



www.wago.com/787-783/000-040



i Picture differs from the item.

Similar to illustration

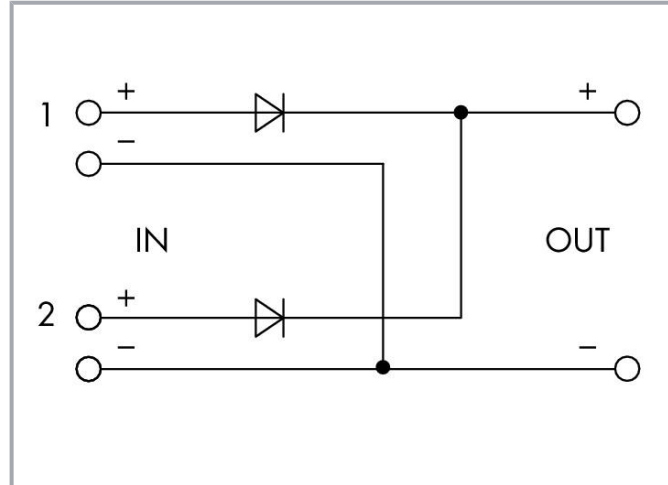

Subject to changes. Please also observe the further product documentation!

WAGO Kontakttechnik GmbH & Co. KG
Hansastr. 27
32423 Minden
Phone: +49571 887-0 | Fax: +49571 887-169
Email: info.de@wago.com | Web: www.wago.com

Do you have any questions about our products?
We are always happy to take your call at +49 (571) 887-44222.



Item description

Features:

- Redundancy module with two inputs decouples two power supplies
- For redundant and fail-safe power supply
- With LED and potential-free contact for input voltage monitoring on site and remotely

Data

Technical data

Nominal input voltage $U_{i\text{nom}}$	2 x DC 24 V
Input voltage range	2 x DC 9 ... 54 V

Subject to changes. Please also observe the further product documentation!

WAGO Kontakttechnik GmbH & Co. KG
Hansastr. 27
32423 Minden
Phone: +49571 887-0 | Fax: +49571 887-169
Email: info.de@wago.com | Web: www.wago.com

Do you have any questions about our products?
We are always happy to take your call at +49 (571) 887-44222.



Nominal mains frequency range	0 Hz
Input current I_i	≤ 12.5 A (per path)
Isolation voltage (connectors – housing)	DC 0.5 kV
Protection class	III
Protection type	IP20 (per EN 60529)
Resistance to reverse feed	\leq DC 60 V
Pollution degree	2
Overvoltage protection; secondary	No
Short-circuit-protected	No
Open-circuit-proof	Yes
Parallel operation	Yes
Series operation	No
MTBF	> 10 million h (per IEC 61709)
Signaling	1 x IN1 LED (green) 1 x IN2 LED (green) 1 x OUT LED (green)
Operation status indicator	2 x Green LED ($U_i > 7.5$ VDC) 1 x Green LED ($U_o > 7.5$ VDC)
Power loss P_i	≤ 19 W (nominal load)
Efficiency (typ.)	96 %
Nominal output voltage $U_{o\text{ nom}}$	DC 24 V
Output voltage range	DC 9 ... 54 V (U_e – voltage drop)
Voltage drop	≤ 0.8 V (Input/output)
Nominal output current $I_{o\text{ nom}}$	25 A
Nominal output power	600 W
Output power (max.)	≤ 1350 W

Connection data

Connection type (1)	Input/Output
Connection technology	Push-in CAGE CLAMP®
WAGO Connector	WAGO 2706 Series
Solid conductor	0.5 ... 6 mm ² / 20 ... 10 AWG
Fine-stranded conductor	0.5 ... 6 mm ² / 20 ... 10 AWG
Strip length	11 ... 12 mm / 0.43 ... 0.47 inch

Subject to changes. Please also observe the further product documentation!



Physical data

Width	50 mm / 1.969 inch
Height	130 mm / 5.118 inch
Depth from upper edge of DIN-rail	92 mm / 3.662 inch

Mechanical data

Mounting type	DIN-35 rail
---------------	-------------

Material data

Weight	470 g
--------	-------

Environmental requirements

Surrounding air temperature (operation)	-25 ... 70 °C
Surrounding air temperature (storage)	-40 ... 85 °C
Relative humidity	95% (no condensation permissible)
Derating	-2.66 %/K (55 °C < T _U ≤ 70 °C)
Resistance to shock and vibration	Shock: 15g (per EN 60068-2-27)

Standards and specifications

Conformity marking	CE
Standards/Specifications	UL 508 ATEX IEC Ex ANSI/ISA 12.12.01 (Class I Div. 2)

Commercial data

PU (SPU)	1 Stück
Packaging type	box
Country of origin	CN
GTIN	4055143889605
Customs tariff number	85044082900

Approvals / Certificates

Ex-Approvals



Logo	Approval	Additional Approval Text	Certificate name
	ATEX	EN 60079-0	BVS 17 ATEX E 010

Subject to changes. Please also observe the further product documentation!

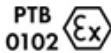

DEKRA EXAM GmbH

X







 Ex nA IIC T4 Gc	CCCEX CQST/CNEx	CNCA-C23-01	2020312303000382
	EAC Brjansker Zertifizierungsstelle	TP TC 012/2011	EAC RU C-DE.AM02. B.00132/19
	IECEX DEKRA EXAM GmbH	IEC 60079-0	IECEX BVS 17.0003X

UL-Approvals

















Logo	Approval	Additional Approval Text	Certificate name
	UL Underwriters Laboratories Inc.	UL 508	E255817
	UL Underwriters Laboratories Inc.	ANSI/ISA 12.12.01	E484199

Optional accessories





Ferrule

Ferrule		
	Item no.: 216-203 Ferrule; Sleeve for 1 mm ² / AWG 18; insulated; electro-tin plated; red	www.wago.com/216-203
	Item no.: 216-206 Ferrule; Sleeve for 2.5 mm ² / AWG 14; insulated; electro-tin plated; blue	www.wago.com/216-206
	Item no.: 216-207 Ferrule; Sleeve for 4 mm ² / AWG 12; insulated; electro-tin plated; gray	www.wago.com/216-207
	Item no.: 216-202 Ferrule; Sleeve for 0.75 mm ² / 18 AWG; insulated; electro-tin plated; gray	www.wago.com/216-202

Subject to changes. Please also observe the further product documentation!

	Item no.: 216-204 Ferrule; Sleeve for 1.5 mm ² / AWG 16; insulated; electro-tin plated; black	www.wago.com/216-204
	Item no.: 216-205 Ferrule; Sleeve for 2.08 mm ² / AWG 14; insulated; electro-tin plated; yellow	www.wago.com/216-205
	Item no.: 216-208 Ferrule; Sleeve for 6 mm ² / AWG 10; insulated; electro-tin plated; electrolytic copper; gastight crimped; acc. to DIN 46228, Part 4/09.90; yellow	www.wago.com/216-208
	Item no.: 216-201 Ferrule; Sleeve for 0.5 mm ² / 20 AWG; insulated; electro-tin plated; white	www.wago.com/216-201
	Item no.: 216-223 Ferrule; Sleeve for 1 mm ² / AWG 18; insulated; electro-tin plated; red	www.wago.com/216-223
	Item no.: 216-241 Ferrule; Sleeve for 0.5 mm ² / 20 AWG; insulated; electro-tin plated; electrolytic copper; gastight crimped; acc. to DIN 46228, Part 4/09.90; white	www.wago.com/216-241
	Item no.: 216-242 Ferrule; Sleeve for 0.75 mm ² / 18 AWG; insulated; electro-tin plated; electrolytic copper; gastight crimped; acc. to DIN 46228, Part 4/09.90; gray	www.wago.com/216-242
	Item no.: 216-222 Ferrule; Sleeve for 0.75 mm ² / 18 AWG; insulated; electro-tin plated; gray	www.wago.com/216-222
	Item no.: 216-221 Ferrule; Sleeve for 0.5 mm ² / 20 AWG; insulated; electro-tin plated; white	www.wago.com/216-221
	Item no.: 216-224 Ferrule; Sleeve for 1.5 mm ² / AWG 16; insulated; electro-tin plated; black	www.wago.com/216-224
	Item no.: 216-243 Ferrule; Sleeve for 1 mm ² / AWG 18; insulated; electro-tin plated; electrolytic copper; gastight crimped; acc. to DIN 46228, Part 4/09.90; red	www.wago.com/216-243
	Item no.: 216-244 Ferrule; Sleeve for 1.5 mm ² / AWG 16; insulated; electro-tin plated; electrolytic copper; gastight crimped; acc. to DIN 46228, Part 4/09.90; black	www.wago.com/216-244
	Item no.: 216-263 Ferrule; Sleeve for 1 mm ² / AWG 18; insulated; electro-tin plated; electrolytic copper; gastight crimped; acc. to DIN 46228, Part 4/09.90; red	www.wago.com/216-263
	Item no.: 216-246 Ferrule; Sleeve for 2.5 mm ² / AWG 14; insulated; electro-tin plated; electrolytic copper; gastight crimped; acc. to DIN 46228, Part 4/09.90; blue	www.wago.com/216-246
	Item no.: 216-266 Ferrule; Sleeve for 2.5 mm ² / AWG 14; insulated; electro-tin plated; electrolytic copper; gastight crimped; acc. to DIN 46228, Part 4/09.90; blue	www.wago.com/216-266
	Item no.: 216-264 Ferrule; Sleeve for 1.5 mm ² / AWG 16; insulated; electro-tin plated; electrolytic copper; gastight crimped; acc. to DIN 46228, Part 4/09.90; black	www.wago.com/216-264
	Item no.: 216-284 Ferrule; Sleeve for 1.5 mm ² / AWG 16; insulated; electro-tin plated; electrolytic copper; gastight crimped; acc. to DIN 46228, Part 4/09.90; black	www.wago.com/216-284

Subject to changes. Please also observe the further product documentation!

	Item no.: 216-286 Ferrule; Sleeve for 2.5 mm ² / AWG 14; insulated; electro-tin plated; electrolytic copper; gastight crimped; acc. to DIN 46228, Part 4/09.90; blue	www.wago.com/216-286
	Item no.: 216-287 Ferrule; Sleeve for 4 mm ² / AWG 12; insulated; electro-tin plated; electrolytic copper; gastight crimped; acc. to DIN 46228, Part 4/09.90; gray	www.wago.com/216-287
	Item no.: 216-262 Ferrule; Sleeve for 0.75 mm ² / 18 AWG; insulated; electro-tin plated; electrolytic copper; gastight crimped; acc. to DIN 46228, Part 4/09.90; gray	www.wago.com/216-262
	Item no.: 216-288 Ferrule; Sleeve for 6 mm ² / AWG 10; insulated; electro-tin plated; electrolytic copper; gastight crimped; acc. to DIN 46228, Part 4/09.90; yellow	www.wago.com/216-288
	Item no.: 216-267 Ferrule; Sleeve for 4 mm ² / AWG 12; insulated; electro-tin plated; electrolytic copper; gastight crimped; acc. to DIN 46228, Part 4/09.90; gray	www.wago.com/216-267

Downloads

Documentation

Bid Text

787-783/000-040 docx - Datei	2019. 8. 23.	docx 22.5 kB	Download
787-783/000-040 X81 - Datei	2019. 8. 23.	xml 6.0 kB	Download

Instruction Leaflet

Diode Redundancy Module DC 24 V, 12,5 A	V 1.2.0 2021. 9. 29.	pdf 3.9 MB	Download
--	-------------------------	---------------	----------

Additional Information

Disposal; Electrical and electronic equipment, Packaging	V 1.0.0	pdf 265.8 kB	Download
--	---------	-----------------	----------

Environmental Product Compliance

Compliance Search

Environmental Product Compliance 787-783/000-040 Redundancy Module; 2 x 9 ... 54 VDC input voltage; 2 x 12.5 A input current; 9-54 VDC output voltage; 25 A output current	URL	Download
---	-----	----------

Subject to changes. Please also observe the further product documentation!



Installation Notes

Subject to changes. Please also observe the further product documentation!

WAGO Kontakttechnik GmbH & Co. KG
Hansastr. 27
32423 Minden
Phone: +49571 887-0 | Fax: +49571 887-169
Email: info.de@wago.com | Web: www.wago.com

Do you have any questions about our products?
We are always happy to take your call at +49 (571) 887-44222.