

MSKSEMI

SEMICONDUCTOR

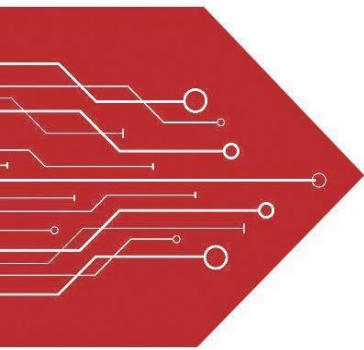

ESD



TVS



TSS

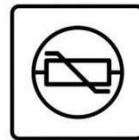

MOV



GDT



PLED

Product data sheet

FEATURES

- ◆ Glass passivated device
- ◆ Ideal for surface mouted applications
- ◆ Low reverse leakage
- ◆ Metallurgically bonded construction
- ◆ High temperature soldering guaranteed:
250°C/10 seconds, 0.375" (9.5mm) lead length,
5 lbs. (2.3kg) tension

MECHANICAL DATA

Case: JEDEC SOD-123FL molded plastic body over passivated chip
Terminals: Solderable per MIL-STD-750, Method 2026
Polarity: Color band denotes cathode end
Mounting Position: Any
Weight: 0.0007 ounce, 0.02 grams

MAXIMUM RATINGS AND ELECTRICAL CHARACTERISTICS

Ratings at 25°C ambient temperature unless otherwise specified.
 Single phase half-wave 60Hz, resistive or inductive load, for capacitive load current derate by 20%.

	P/N	SOD4001-MS	SOD4002-MS	SOD4003-MS	SOD4004-MS	SOD4005-MS	SOD4006-MS	SOD4007-MS	UNITS
	MARK	A1	A2	A3	A4	A5	A6	A7	
Maximum repetitive peak reverse voltage	V_{RRM}	50	100	200	400	600	800	1000	VOLTS
Maximum RMS voltage	V_{RMS}	35	70	140	280	420	560	700	VOLTS
Maximum DC blocking voltage	V_{DC}	50	100	200	400	600	800	1000	VOLTS
Maximum average forward rectified current at $T_A=65^\circ\text{C}$ (NOTE 1)	$I_{(AV)}$	1.0							Amp
Peak forward surge current 8.3ms single half sine-wave superimposed on rated load (JEDEC Method) $T_L=25^\circ\text{C}$	I_{FSM}	25.0							Amps
Maximum instantaneous forward voltage at 1.0A	V_F	1.0							Volts
Maximum DC reverse current at rated DC blocking voltage	I_R	10.0 50.0							μA
Typical junction capacitance (NOTE 2)	C_J	4							pF
Typical thermal resistance (NOTE 3)	$R_{\theta JA}$	180							K/W
Operating junction and storage temperature range	T_J, T_{STG}	-55 to +150							$^\circ\text{C}$

- Note:** 1. Averaged over any 20ms period.
 2. Measured at 1MHz and applied reverse voltage of 4.0V D.C.
 3. Thermal resistance from junction to ambient at 0.375" (9.5mm) lead length, P.C.B. mounted

FIG.1 --TYPICAL FORWARD CHARACTERISTIC

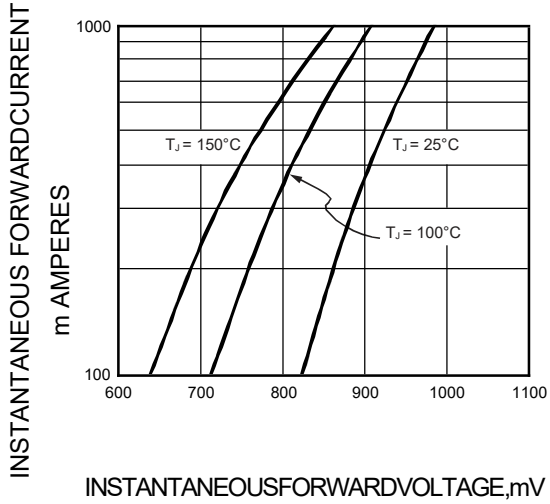

FIG.2 -- TYPICAL JUNCTION CAPACITANCE

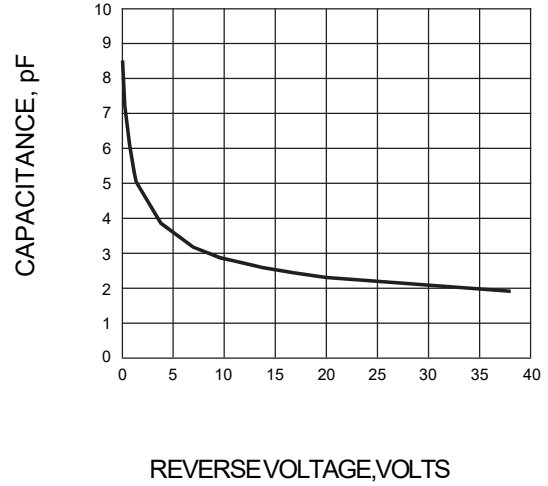

FIG.3 --TYPICAL INSTANTANEOUS REVERSE CHARACTERISTICS

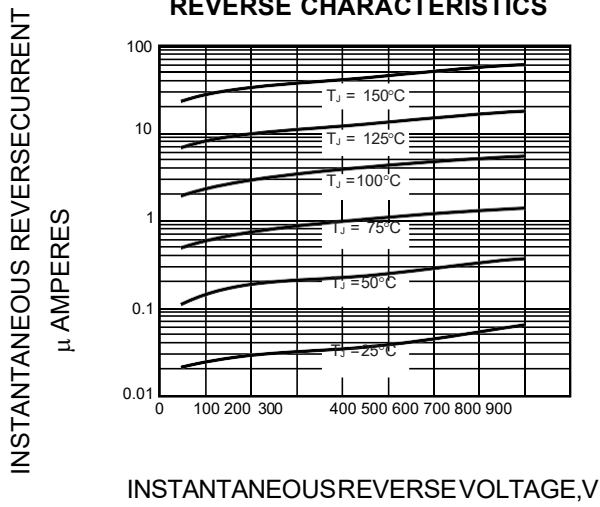
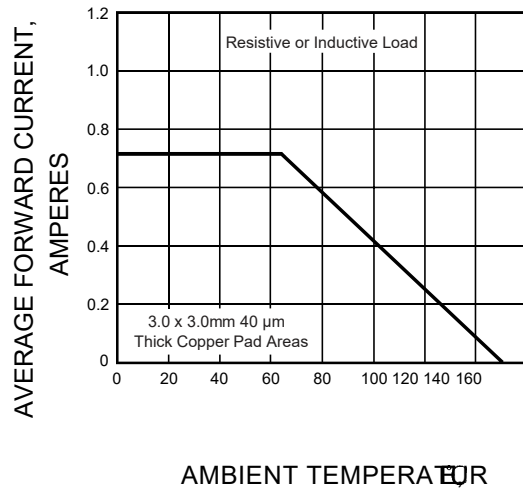
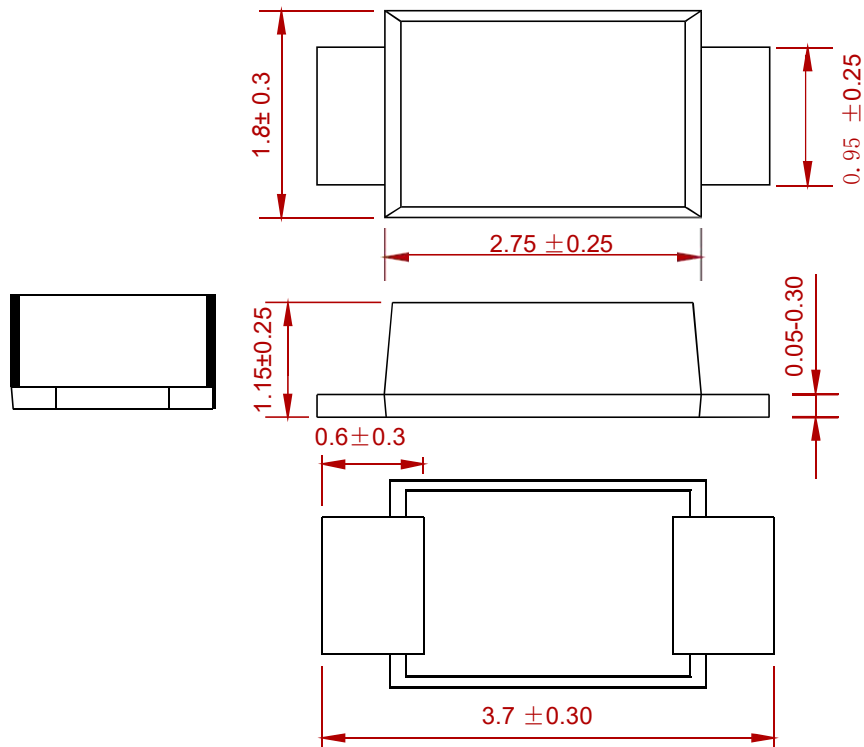

FIG.4 -- FORWARD DERATING CURVE



PACKAGE MECHANICAL DATA



Dimensions in millimeters

Suggested Pad Layout

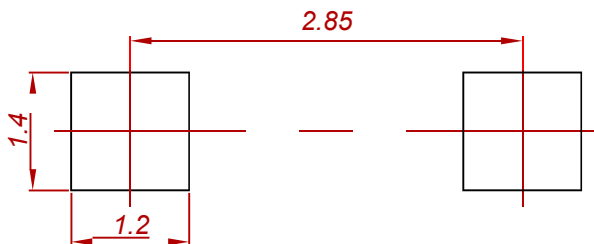

Note:

1. Controlling dimension: in millimeters.
2. General tolerance: ± 0.05 mm.
3. The pad layout is for reference purposes only.

REEL SPECIFICATION

P/N	PKG	QTY
SOD4001-MS THRU SOD4007-MS	SOD-123FL	3000

Attention

- Any and all MSKSEMI Semiconductor products described or contained herein do not have specifications that can handle applications that require extremely high levels of reliability, such as life-support systems, aircraft's control systems, or other applications whose failure can be reasonably expected to result in serious physical and/or material damage. Consult with your MSKSEMI Semiconductor representative nearest you before using any MSKSEMI Semiconductor products described or contained herein in such applications.
- MSKSEMI Semiconductor assumes no responsibility for equipment failures that result from using products at values that exceed, even momentarily, rated values (such as maximum ratings, operating condition ranges, or other parameters) listed in products specifications of any and all MSKSEMI Semiconductor products described or contained herein.
- Specifications of any and all MSKSEMI Semiconductor products described or contained herein stipulate the performance, characteristics, and functions of the described products in the independent state, and are not guarantees of the performance, characteristics, and functions of the described products as mounted in the customer's products or equipment. To verify symptoms and states that cannot be evaluated in an independent device, the customer should always evaluate and test devices mounted in the customer's products or equipment.
- MSKSEMI Semiconductor strives to supply high-quality high-reliability products. However, any and all semiconductor products fail with some probability. It is possible that these probabilistic failures could give rise to accidents or events that could endanger human lives, that could give rise to smoke or fire, or that could cause damage to other property. When designing equipment, adopt safety measures so that these kinds of accidents or events cannot occur. Such measures include but are not limited to protective circuits and error prevention circuits for safe design, redundant design, and structural design.
- In the event that any or all MSKSEMI Semiconductor products (including technical data, services) described or contained herein are controlled under any of applicable local export control laws and regulations, such products must not be exported without obtaining the export license from the authorities concerned in accordance with the above law.
- No part of this publication may be reproduced or transmitted in any form or by any means, electronic or mechanical, including photocopying and recording, or any information storage or retrieval system, or otherwise, without the prior written permission of MSKSEMI Semiconductor.
- Information (including circuit diagrams and circuit parameters) herein is for example only; it is not guaranteed for volume production. MSKSEMI Semiconductor believes information herein is accurate and reliable, but no guarantees are made or implied regarding its use or any infringements of intellectual property rights or other rights of third parties.
- Any and all information described or contained herein are subject to change without notice due to product/technology improvement, etc. When designing equipment, refer to the "Delivery Specification" for the MSKSEMI Semiconductor product that you intend to use.