

Coaxial Amplifier

ZFL-1HAD

50Ω High Isolation 10 to 500 MHz

Features

- wideband, 10 to 500 MHz
- active directivity (isolation-gain), 30 dB typ.

Applications

- VHF/UHF
- laboratory use
- receivers
- two-tone, 3rd order IM testing

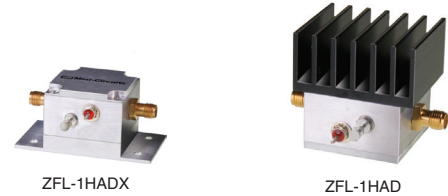

ZFL-1HADX

ZFL-1HAD

CASE STYLE: SS98

Connectors	Model
SMA	ZFL-1HAD
BRACKET (OPTION "B")	
SMA	ZFL-1HADX

Amplifier Electrical Specifications

MODEL NO.	FREQUENCY (MHz)		GAIN (dB)		MAXIMUM POWER (dBm)			DYNAMIC RANGE		VSWR (:1) Typ.		ACTIVE DIRECTIVITY ¹ (dB)				DC POWER	
	f _L	f _U	Min.	Flatness Max. Total Range	Output (1 dB Compr.)			NF (dB) Typ.	IP3 (dBm) Typ.	In ²	Out	L _w		U		Volt (V) Nom.	Current (mA) Max.
ZFL-1HAD	10	500	10	±1.0	+20	+20	+17	7.5	+30	1.3	1.35	30	20	25	18	15	115
ZFL-1HADX*	10	500	10	±1.0	+20	+20	+17	7.5	+30	1.3	1.35	30	20	25	18	15	115

* Heat sink not included

L_w= low range (f_L to f_U/2)

U= upper range (f_U/2 to f_U)

¹Active Directivity(dB)= Isolation (dB)- Gain (dB)

² Input VSWR in 10-20 MHz band increases to 1.45:1 at -20°C.

Below 50 MHz, NF increases to 11dB typ. at 10 MHz

Open load is not recommended, potentially can cause damage.

With no load derate max input power by 20 dB

To order without heat sink, add suffix X to model number. Alternative heat sinking and heat removal must be provided by the user to limit maximum temperature to 71°C, in order to ensure proper performance. For reference, this requires thermal resistance of user's external heat sink to be 15°C/W Max.

Maximum Ratings

Operating Temperature -20°C to 71°C

Storage Temperature -55°C to 100°C

DC Voltage +17V Max.

Permanent damage may occur if any of these limits are exceeded.

Outline Drawing

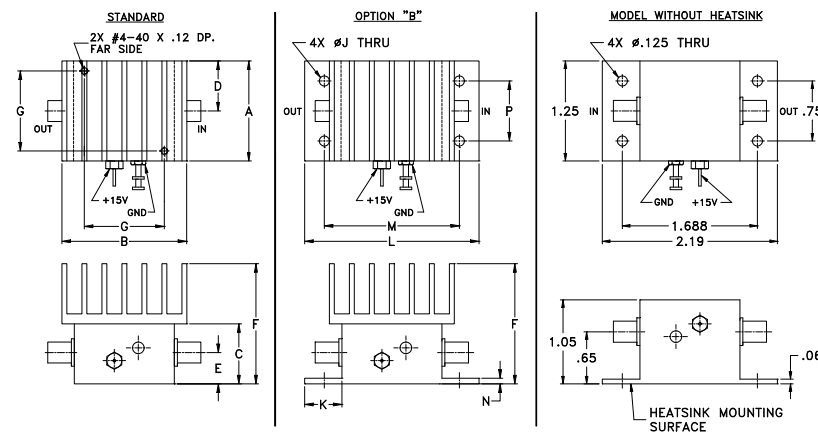

Outline Dimensions (inch/mm)

A	B	C	D	E	F	G	H	J	K	L	M	N	P	wt*
1.25	1.56	.75	.63	.39	1.50	1.000	--	.125	.46	2.19	1.688	.06	.750	grams
31.75	39.62	19.05	16.00	9.91	38.10	25.40	--	3.18	11.68	55.63	42.88	1.52	19.05	85.0
														*70 grams without heat sink

Notes

A. Performance and quality attributes and conditions not expressly stated in this specification document are intended to be excluded and do not form a part of this specification document.

B. Electrical specifications and performance data contained in this specification document are based on Mini-Circuit's applicable established test performance criteria and measurement instructions.

C. The parts covered by this specification document are subject to Mini-Circuits standard limited warranty and terms and conditions (collectively, "Standard Terms"); Purchasers of this part are entitled to the rights and benefits contained therein. For a full statement of the Standard Terms and the exclusive rights and remedies thereunder, please visit Mini-Circuits' website at www.minicircuits.com/MCLStore/terms.jsp

REV. B
M151107
ZFL-1HAD
151005



Typical Performance Data/Curves

ZFL-1HAD

FREQUENCY (MHz)	GAIN (dB)			DIRECTIVITY (dB)			VSWR (:1)		NOISE FIGURE (dB)	POUT at 1 dB COMPR. (dBm)
	12V	15V	16V	12V	15V	16V	IN	OUT		
10.00	11.57	11.63	11.65	27.40	27.50	27.40	1.13	1.11	6.77	20.80
19.30	11.30	11.37	11.38	30.10	30.20	30.20	1.21	1.10	6.78	22.17
46.50	11.31	11.38	11.40	31.10	31.20	31.20	1.21	1.09	6.75	22.56
111.80	11.48	11.56	11.58	31.60	31.70	31.50	1.18	1.12	6.76	22.61
198.50	11.61	11.74	11.76	32.40	32.60	32.80	1.16	1.17	6.82	22.21
248.70	11.74	11.90	11.94	32.70	33.30	33.40	1.15	1.19	6.93	21.99
311.50	11.89	12.13	12.18	31.40	32.60	33.00	1.14	1.19	7.05	21.71
374.40	12.08	12.38	12.45	28.30	29.20	29.30	1.13	1.17	7.19	21.35
437.20	12.23	12.60	12.69	25.20	25.50	25.60	1.13	1.12	7.33	21.27
500.00	12.37	12.83	12.94	21.60	21.70	21.70	1.17	1.07	7.46	21.26

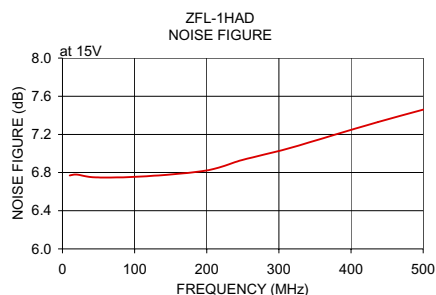
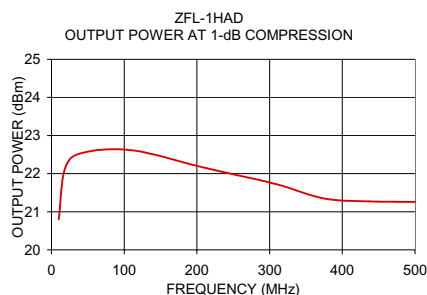
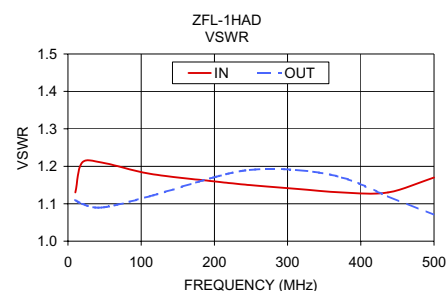
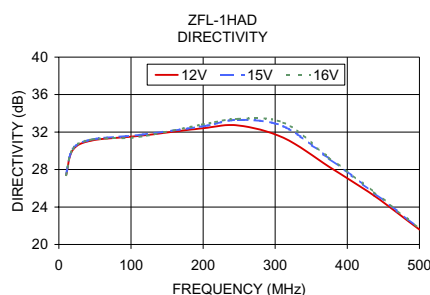
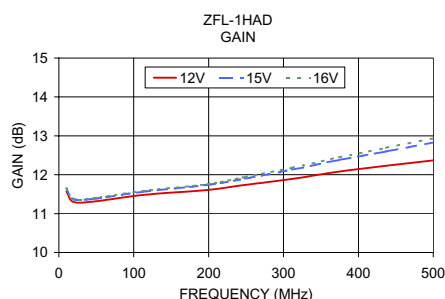

Notes

- A. Performance and quality attributes and conditions not expressly stated in this specification document are intended to be excluded and do not form a part of this specification document.
- B. Electrical specifications and performance data contained in this specification document are based on Mini-Circuit's applicable established test performance criteria and measurement instructions.
- C. The parts covered by this specification document are subject to Mini-Circuits standard limited warranty and terms and conditions (collectively, "Standard Terms"); Purchasers of this part are entitled to the rights and benefits contained therein. For a full statement of the Standard Terms and the exclusive rights and remedies thereunder, please visit Mini-Circuits' website at www.minicircuits.com/MCLStore/terms.jsp

