

Features

- Fundamental Image Reject Mixer
- 8.0 dB Conversion Loss
- 20.0 dB Image Rejection
- +25.0 dBm Input Third Order Intercept (IIP3)
- 100% On-Wafer RF Testing
- 100% Visual Inspection to MIL-STD-883 Method 2010
- RoHS* Compliant and 260°C Reflow Compatible

Description

M/A-COM Tech's 12.0-40.0 GHz GaAs MMIC fundamental image reject mixer can be used as an up- or down-converter. The device has a conversion loss of 8.0 dB with a 20.0 dB image rejection across the band. I and Q mixer outputs are provided and an external 90 degree hybrid is required to select the desired sideband. This MMIC uses M/A-COM Tech's GaAs PHEMT device model technology, and is based upon electron beam lithography to ensure high repeatability and uniformity. The chip has surface passivation to protect and provide a rugged part with backside via holes and gold metallization to allow either a conductive epoxy or eutectic solder die attach process. This device is well suited for Millimeter-wave Point-to-Point Radio, LMDS, SATCOM and VSAT applications.

Ordering Information

Part Number	Package
XM1001-BD-000V	"V" - vacuum release gel paks
XM1001-BD-EV1	evaluation module

Chip Device Layout

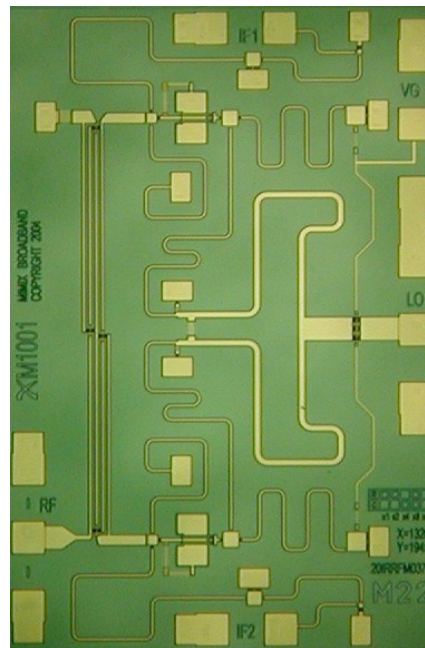

Absolute Maximum Ratings

Parameter	Absolute Max.
Gate Bias Voltage (Vg)	+0.3 VDC
Input Power (RF Pin)	+20.0 dBm
Input Power (IF Pin)	+20.0 dBm
Storage Temperature (Tstg)	-65 °C to +165 °C
Operating Temperature (Ta)	-55 °C to +125 °C

XM1001-BD



Image Reject Mixer
12.0-40.0 GHz

Rev. V1
MimiX Broadband

Electrical Specifications: 12-40 GHz (Upper Side Band) (Ambient Temperature T = 25°C)

Parameter	Units	Min.	Typ.	Max.
Frequency Range (RF) Lower Side Band	GHz	12.0	-	38.0
Frequency Range (LO)	GHz	8.0	-	42.0
Frequency Range (IF)	GHz	DC	-	4.0
RF Return Loss (S11)	dB	-	10.0	-
IF Return Loss (S22)	dB	-	TBD	-
LO Return Loss (S33)	dB	-	TBD	-
Conversion Loss (S21)	dB	-	8.0	-
LO Input Drive (P _{LO})	dBm	-	+12.0	-
Image Rejection	dBc	-	20.0	-
Isolation LO/RF	dB	-	16.0	-
Isolation LO/IF	dB	-	TBD	-
Isolation RF/IF	dB	-	TBD	-
Input Third Order Intercept (IIP3)	dBm	-	+25.0	-
Gate Bias Voltage (Vg1)	VDC	-2.0	-0.5	+0.1

ADVANCED: Data Sheets contain information regarding a product M/A-COM Technology Solutions is considering for development. Performance is based on target specifications, simulated results, and/or prototype measurements. Commitment to develop is not guaranteed.

PRELIMINARY: Data Sheets contain information regarding a product M/A-COM Technology Solutions has under development. Performance is based on engineering tests. Specifications are typical. Mechanical outline has been fixed. Engineering samples and/or test data may be available. Commitment to produce in volume is not guaranteed.

• **North America** Tel: 800.366.2266 • **Europe** Tel: +353.21.244.6400
• **India** Tel: +91.80.43537383 • **China** Tel: +86.21.2407.1588
Visit www.macomtech.com for additional data sheets and product information.

M/A-COM Technology Solutions Inc. and its affiliates reserve the right to make changes to the product(s) or information contained herein without notice.

Typical Performance Curves

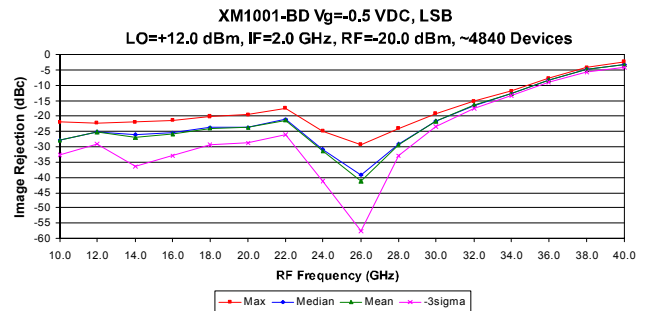
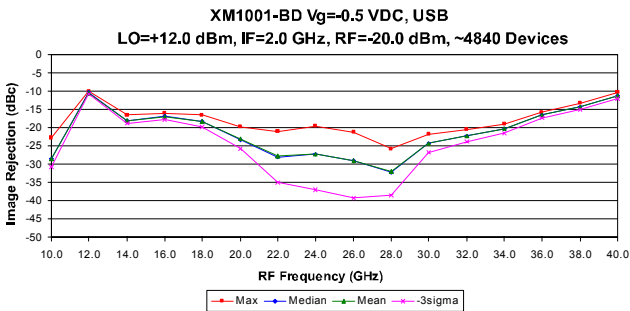
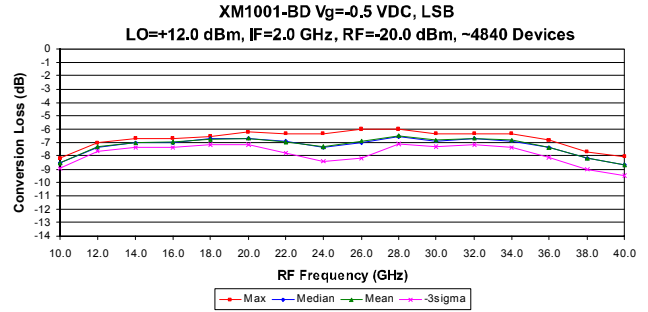
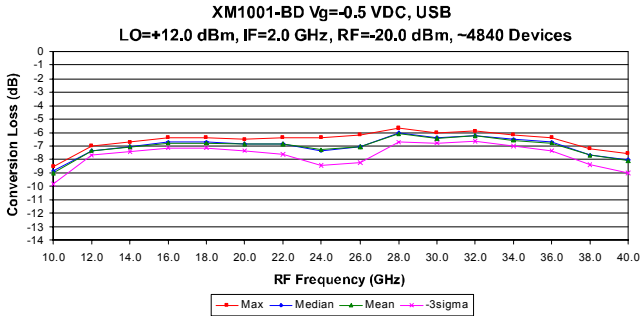

XM1001-BD



Image Reject Mixer
12.0-40.0 GHz

Rev. V1
MimiX Broadband

Typical Performance Curves (cont.)

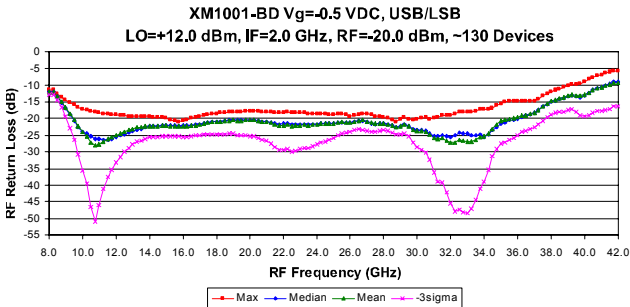
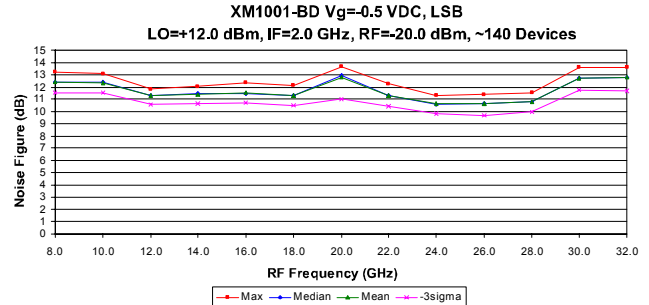
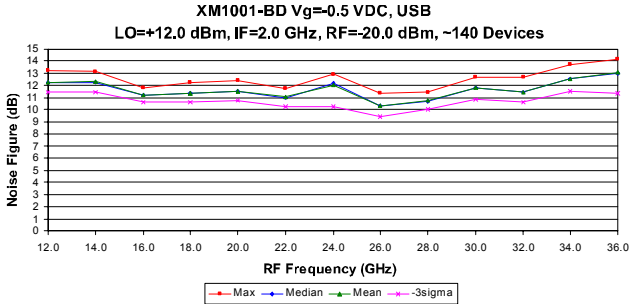

ADVANCED: Data Sheets contain information regarding a product M/A-COM Technology Solutions is considering for development. Performance is based on target specifications, simulated results, and/or prototype measurements. Commitment to develop is not guaranteed.
PRELIMINARY: Data Sheets contain information regarding a product M/A-COM Technology Solutions has under development. Performance is based on engineering tests. Specifications are typical. Mechanical outline has been fixed. Engineering samples and/or test data may be available. Commitment to produce in volume is not guaranteed.

• **North America** Tel: 800.366.2266 • **Europe** Tel: +353.21.244.6400
• **India** Tel: +91.80.43537383 • **China** Tel: +86.21.2407.1588
Visit www.macomtech.com for additional data sheets and product information.

M/A-COM Technology Solutions Inc. and its affiliates reserve the right to make changes to the product(s) or information contained herein without notice.

Image Reject Mixer 12.0-40.0 GHz

Rev. V1
MimiX Broadband

Typical Performance Curves (cont.)

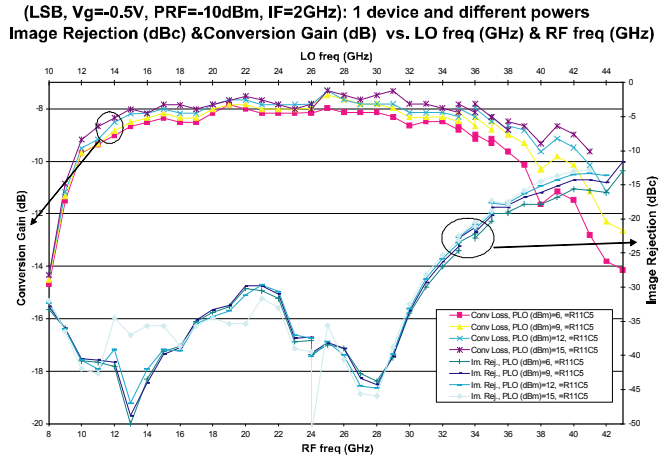
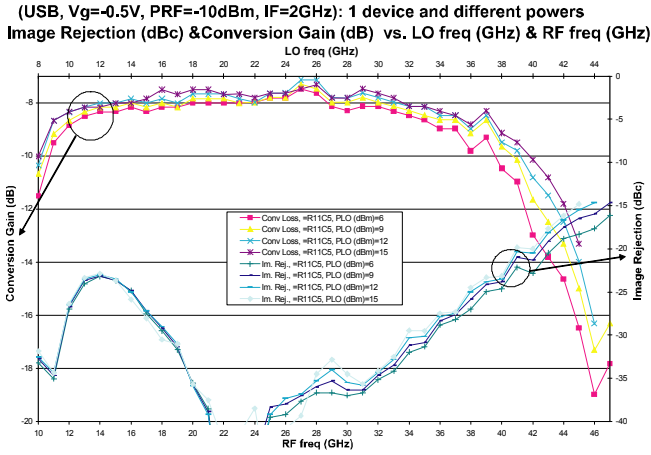
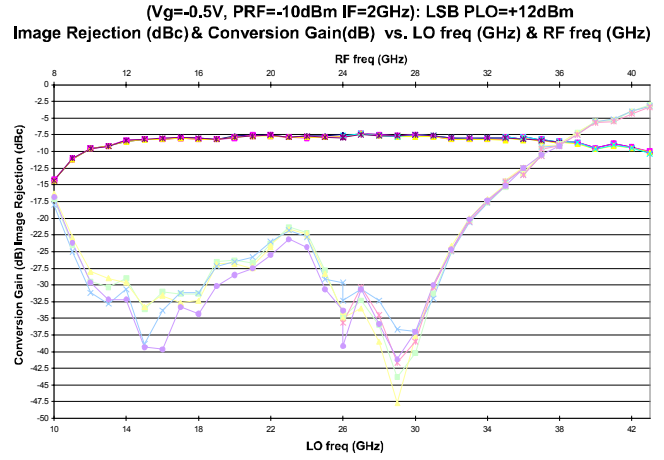
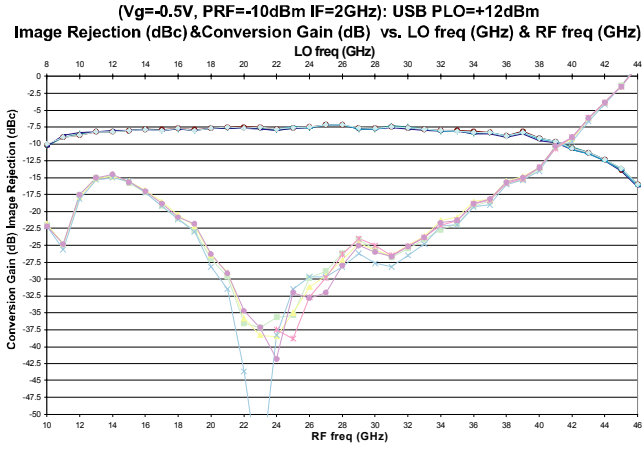

USB Conversion Gain/Image Rejection vs Frequency and for different Vg bias (-2.1V to 0.1V with 0.2V steps) PLO=+12dBm

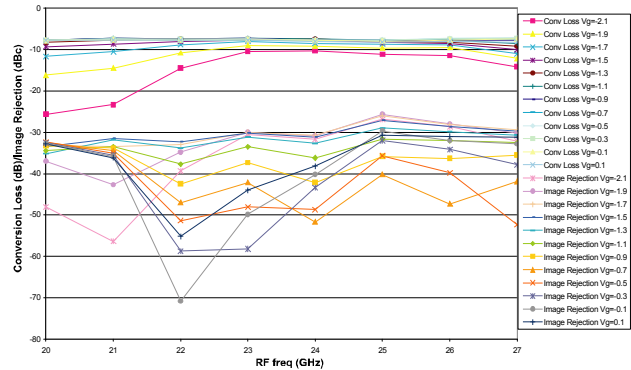

LSB Conversion Gain vs Frequency and for different Vg bias (-2.1V to 0.1V with 0.2V steps) PLO=+12dBm

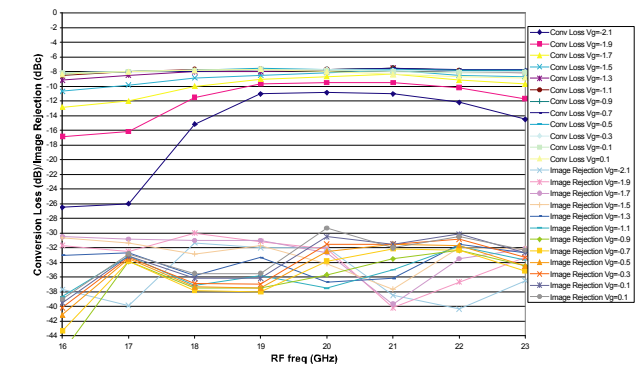

ADVANCED: Data Sheets contain information regarding a product M/A-COM Technology Solutions is considering for development. Performance is based on target specifications, simulated results, and/or prototype measurements. Commitment to develop is not guaranteed.

PRELIMINARY: Data Sheets contain information regarding a product M/A-COM Technology Solutions has under development. Performance is based on engineering tests. Specifications are typical. Mechanical outline has been fixed. Engineering samples and/or test data may be available. Commitment to produce in volume is not guaranteed.

• **North America** Tel: 800.366.2266 • **Europe** Tel: +353.21.244.6400
• **India** Tel: +91.80.43537383 • **China** Tel: +86.21.2407.1588

Visit www.macomtech.com for additional data sheets and product information.

M/A-COM Technology Solutions Inc. and its affiliates reserve the right to make changes to the product(s) or information contained herein without notice.

Typical Performance Curves (cont.)

XM1001-BD (Vg=-0.5V, IF=2GHz, USB, PLO=+6dBm): IP1 & OP1 (dBm) vs. RF & LO freq (GHz)

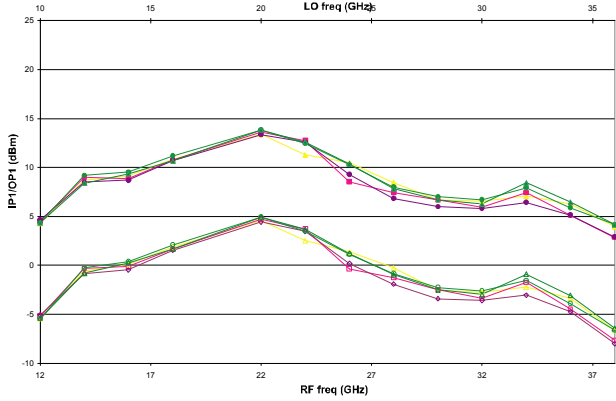

XM1001-BD (Vg=-0.5V, IF=2GHz, LSB, PLO=+6dBm): IP1 & OP1 (dBm) vs. RF & LO freq (GHz)

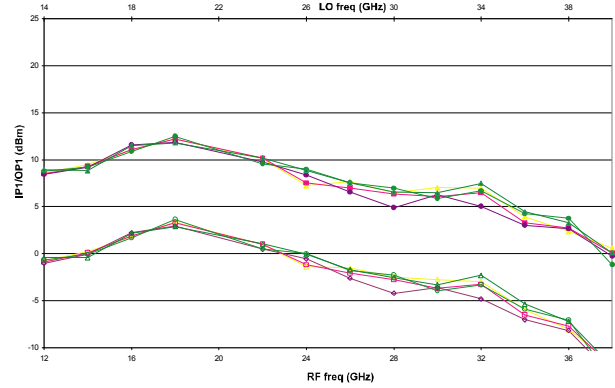

XM1001-BD (Vg=-0.5V, IF=2GHz, USB, PLO=+9dBm): IP1 & OP1 (dBm) vs. RF & LO freq (GHz)

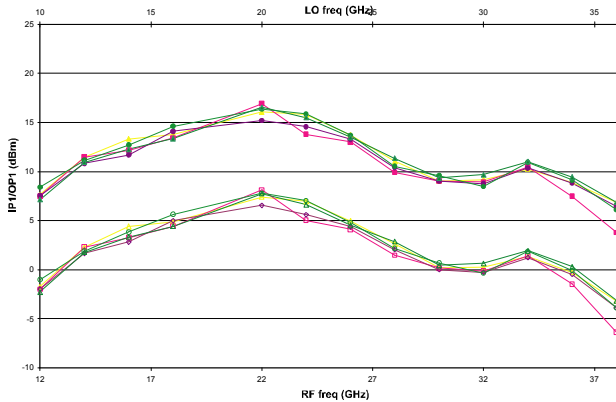

XM1001-BD (Vg=-0.5V, IF=2GHz, LSB, PLO=+9dBm): IP1 & OP1 (dBm) vs. RF & LO freq (GHz)

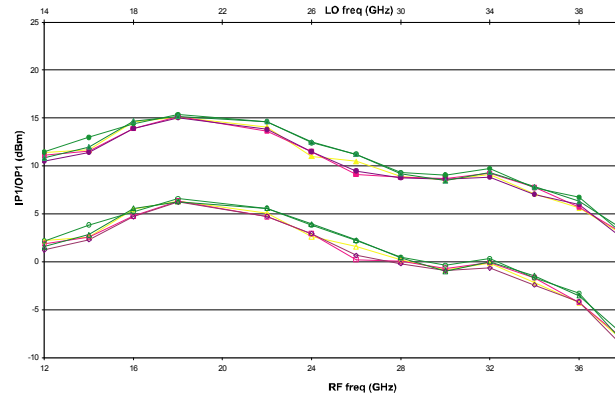

XM1001-BD (Vg=-0.5V, IF=2GHz, USB, PLO=+12dBm): IP1 & OP1 (dBm) vs. RF & LO freq (GHz)

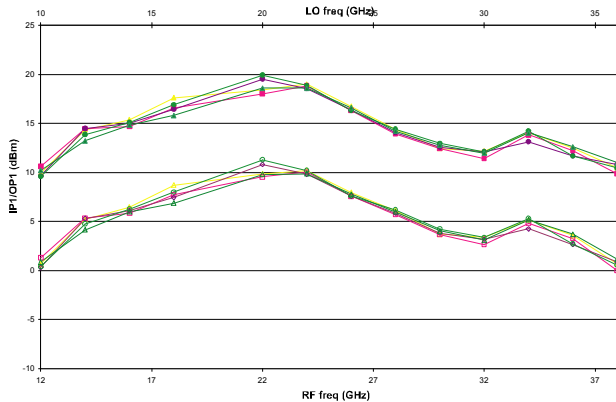

XM1001-BD (Vg=-0.5V, IF=2GHz, LSB, PLO=+12dBm): IP1 & OP1 (dBm) vs. RF & LO freq (GHz)

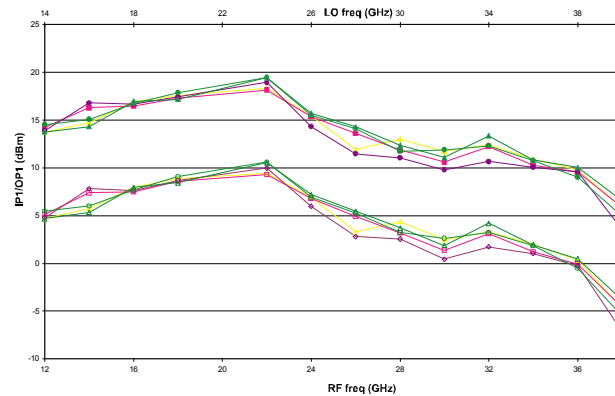

Typical Performance Curves (cont.)

XM1001-BD (Vg=-0.5V, IF=2GHz, USB, PLO=+15dBm):
IP1 & OP1 (dBm) vs. RF & LO freq (GHz)

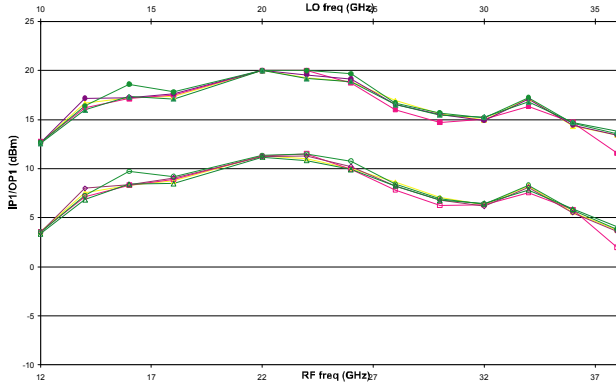

XM1001-BD (Vg=-0.5V, IF=2GHz, LSB, PLO=+15dBm):
IP1 & OP1 (dBm) vs. RF & LO freq (GHz)

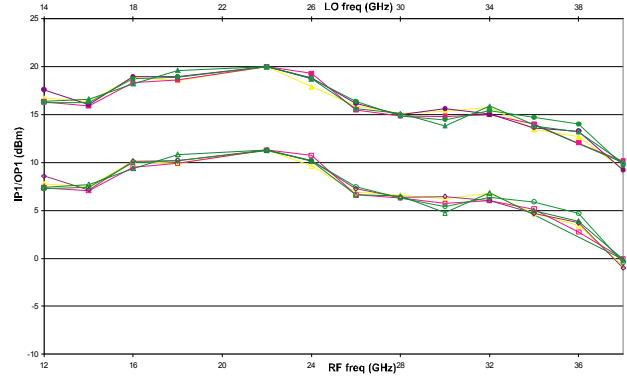

XM1001-BD (Vg=-0.5V, IF=2GHz, LO=+12dBm, IF1-IF2=100MHz, USB, Down Conversion):
IM3 avg vs RF freq f1

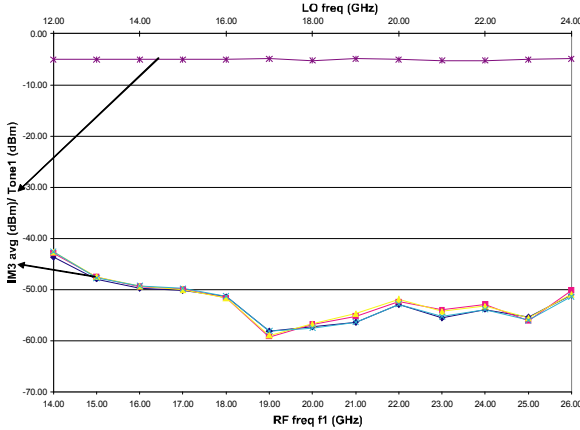

XM1001-BD (Vg=-0.5V, IF=2GHz, LO=+12dBm, IF1-IF2=100MHz, LSB, Down Conversion):
IM3 avg vs RF freq f1

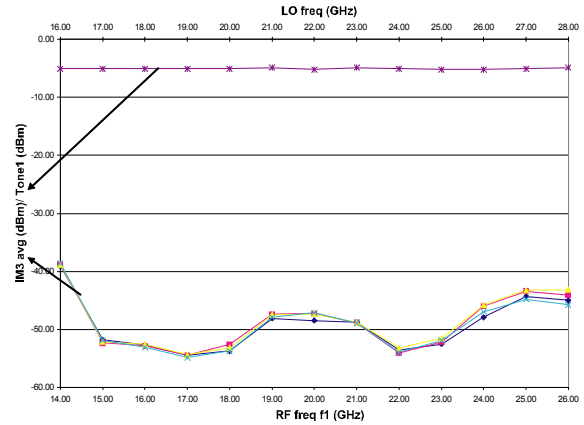

XM1001-BD (Vg=-0.5V, IF=2GHz, LO=+12dBm, IF1-IF2=100MHz, USB, Down Conversion):
OIP3 avg vs RF freq f1, IIP3 vs RF freq f1

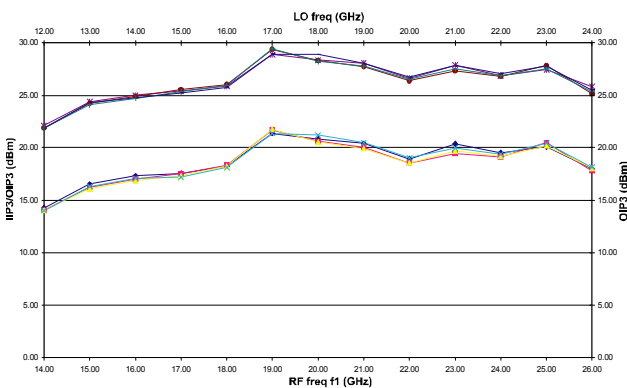

XM1001-BD (Vg=-0.5V, IF=2GHz, LO=+12dBm, IF1-IF2=100MHz, LSB, Down Conversion):
OIP3 avg vs RF freq f1, IIP3 vs RF freq f1

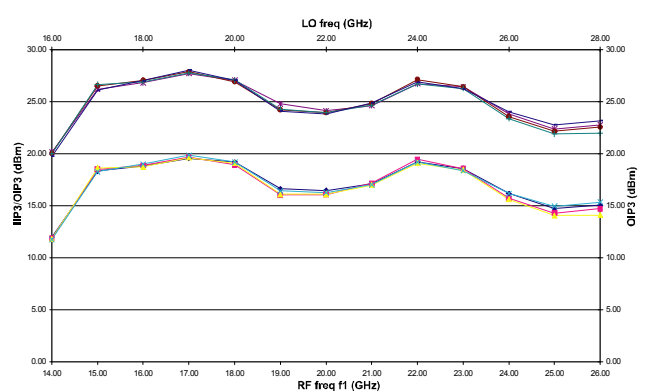

Mechanical Drawing

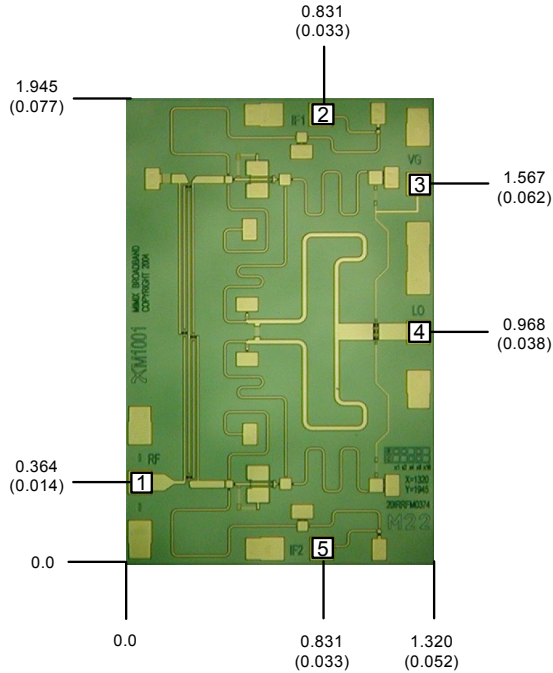

(Note: Engineering designator is 20IRRFM0374)

Units: millimeters (inches) Bond pad dimensions are shown to center of bond pad.
Thickness: 0.110 +/- 0.010 (0.0043 +/- 0.0004), Backside is ground, Bond Pad/Backside Metallization: Gold

All Bond Pads are 0.100 x 0.100 (0.004 x 0.004).
Bond pad centers are approximately 0.109 (0.004) from the edge of the chip.
Dicing tolerance: +/- 0.005 (+/- 0.0002). Approximate weight: 1.592 mg.

Bond Pad #1 (RF) Bond Pad #3 (Vg) Bond Pad #5 (IF2)
Bond Pad #2 (IF1) Bond Pad #4 (LO)

Bias Arrangement

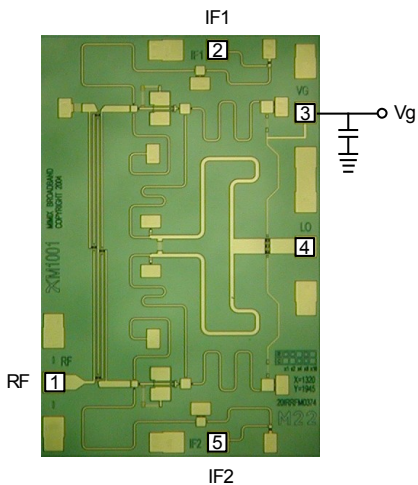

Bypass Capacitors - See App Note [2]

App Note [1] Biasing - As shown in the bonding diagram, the pHEMT mixer devices are operated using a separate gate voltage V_{g1} . Set $V_{g1} = -0.5V$ for optimum conversion loss performance.

App Note [2] Bias Arrangement - Each DC pad (V_{g1}) needs to have DC bypass capacitance ($\sim 100-200$ pF) as close to the device as possible. Additional DC bypass capacitance (~ 0.01 uF) is also recommended.

App Note [3] USB/LSB Selection -

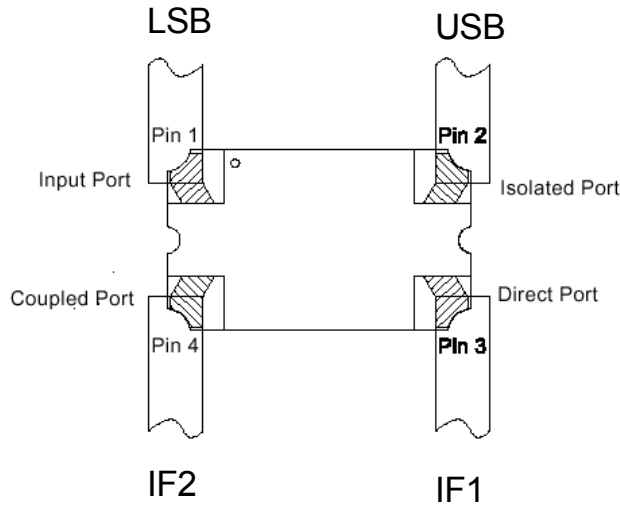

For Upper Side Band Operation (USB): With IF1 and IF2 connected to the direct port (0°) and coupled port (90°) respectively as shown in the diagram, the USB signal will reside on the isolated port. The input port must be loaded with 50 ohms.

For Lower Side Band Operation (LSB): With IF1 and IF2 connected to the direct port (0°) and coupled port (90°) respectively as shown in the diagram, the LSB signal will reside on the input port. The isolated port must be loaded with 50 ohms.

Note: The coupled port can be used as an alternative input but the port location of the Coupled and Direct ports reverse.

An alternate method of Selection of USB or LSB:

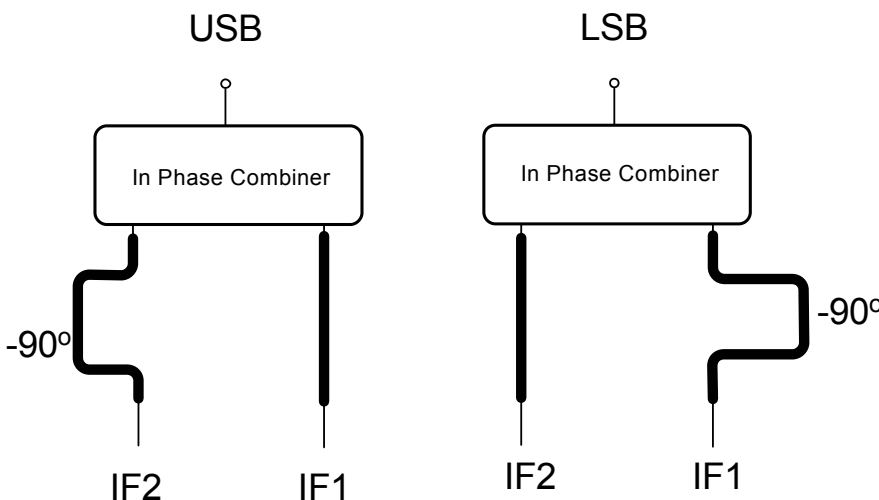

Handling Procedures

Please observe the following precautions to avoid damage:

Static Sensitivity

Gallium Arsenide Integrated Circuits are sensitive to electrostatic discharge (ESD) and can be damaged by static electricity. Proper ESD control techniques should be used when handling these class 2 devices.