

Specifications

- Current rating: 3A AC, DC
- Voltage rating: 250V AC, DC
- Temperature range: -40°C ~ +105°C
- Contact resistance: 20mΩ Max.
- Insulation resistance: 1000MΩ Min.
- Withstanding voltage: 500V AC/minute
- *Compliant with RoHS and REACH*
- *Meet the HF/Halogen Free, need to customize*
- *Contact CJT for details*

Standards



Assembly layout

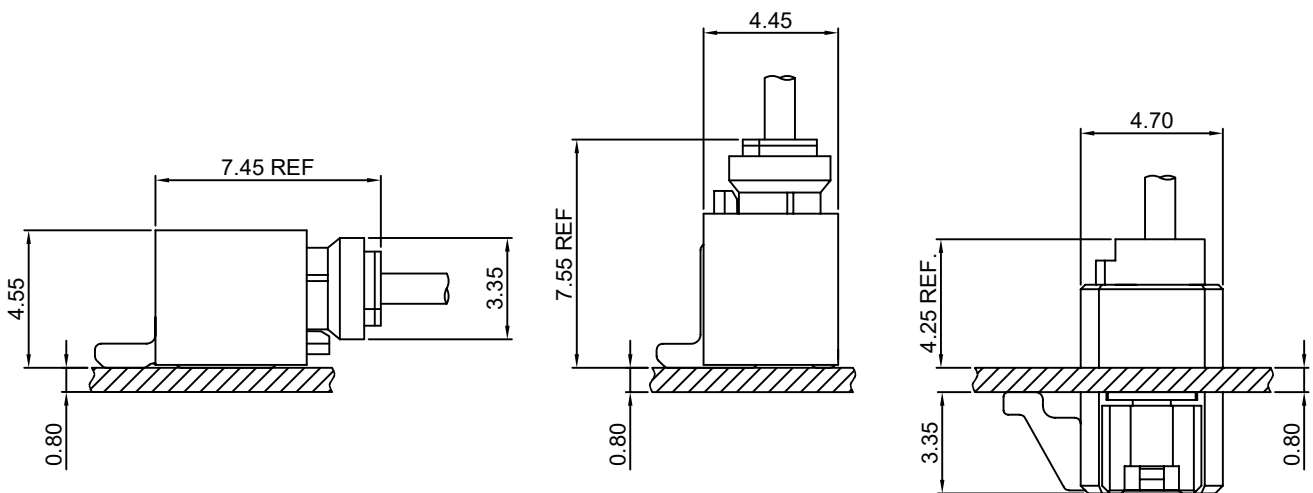

A1502-T

1.50mm pitch Crimp Terminal

Reference Informations:

*Used in CJT A1502H-XP series Housing

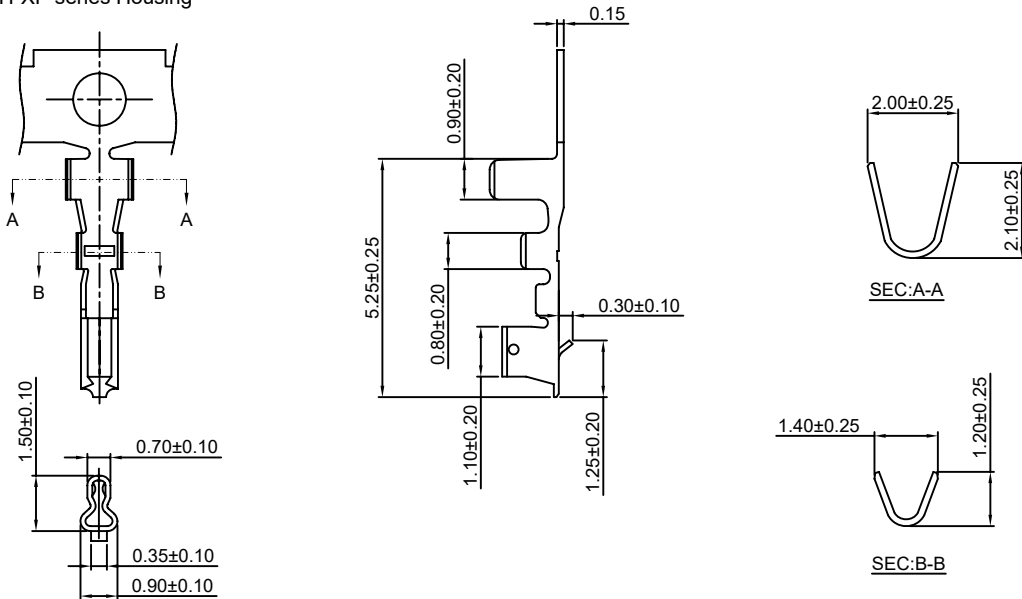

Ordering information & Specifications:

Unit:mm

Part NO.	Wire Range	Insulation O.D.	Material	Finish	Qty/reel
A1502-TP	AWG#24-#28	1.10mm(max)	Phosphor Bronze	Tin over Nickel	10,000 PCS
A1502-GP	AWG#24-#28	1.10mm(max)	Phosphor Bronze	Gold over Nickel	10,000 PCS

Optional Gold plating available but MOQ requested

A1502-T-A

1.50mm pitch Crimp Terminal

Reference Informations:

*Used in CJT A1502HA-XP series Housing

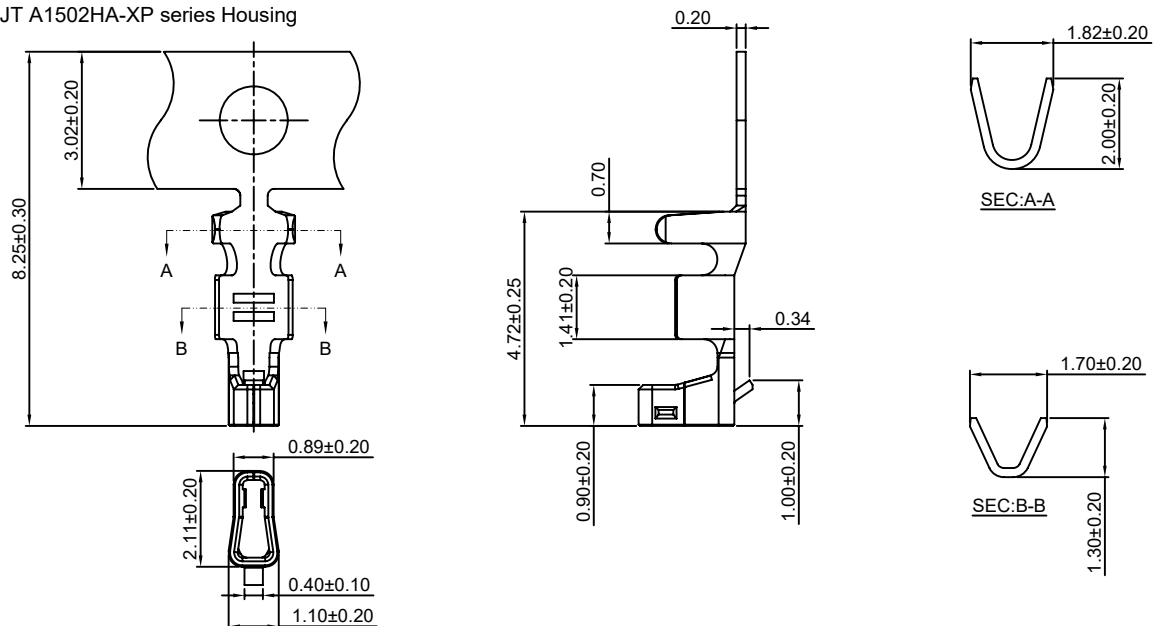

Ordering information & Specifications:

Unit:mm

Part NO.	Wire Range	Insulation O.D.	Material	Finish	Qty/reel
A1502-TP-A	AWG#24-#28	1.10mm(max)	Phosphor Bronze	Tin over Nickel	10,000 PCS
A1502-GP-A	AWG#24-#28	1.10mm(max)	Phosphor Bronze	Gold over Nickel	10,000 PCS

Optional Gold plating available but MOQ requested

A1502H-XP

1.50mm pitch Housing

Reference Informations:

- *Material:Nylon 66,UL94V-0
- *Suitable CJT A1502-T series Terminal
- *Mates with CJT A1502WV,WR,WV-S,WR-S,WVA,WRA-XP series Wafer
- *Color:White

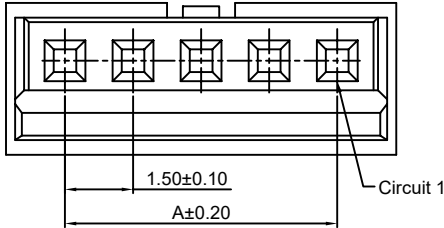

Ordering Information:

A1502H-XP - ** - ***
 1 2 3

- 1.Part No.
- 2.Color:
 (blank) : White
 BK : Black
- 3.Material:
 (Blank):Nylon 66,UL94V-0
 GWT :Nylon 66,UL94V-0 GWT 750 °C

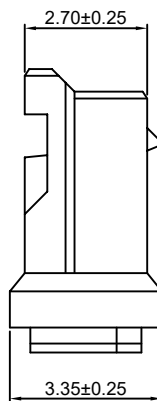
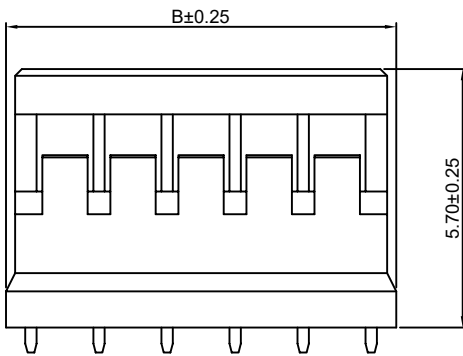
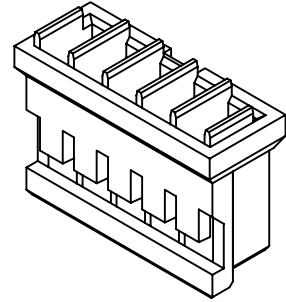

Ordering Information & Dimensions:

PART NO.	Dimensions	
	A	B
2P	1.50	4.10
3P	3.00	5.60
4P	4.50	7.10
5P	6.00	8.60
6P	7.50	10.10
7P	9.00	11.60
8P	10.50	13.10
9P	12.00	14.60
10P	13.50	16.10
11P	15.00	17.60
12P	16.50	19.10
13P	18.00	20.60
14P	19.50	22.10
15P	21.00	23.60

Unit: mm

A1502HA-XP

1.50mm pitch Housing

Reference Informations:

- *Material:Nylon 66,UL94V-0
- *Suitable CJT A1502-T-A series Terminal
- *Mates with CJT A1502WVA-IT-S-XP series Wafer
- *Color:White

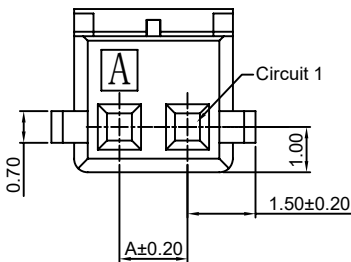

Ordering Information:

A1502HA-XP - ** - ***
 1 2 3

- 1.Part No.
- 2.Color:
 (blank) : White
 BL : Blue
- 3.Material:
 (Blank):Nylon 66,UL94V-0
 GWT :Nylon 66,UL94V-0 GWT 750 °C

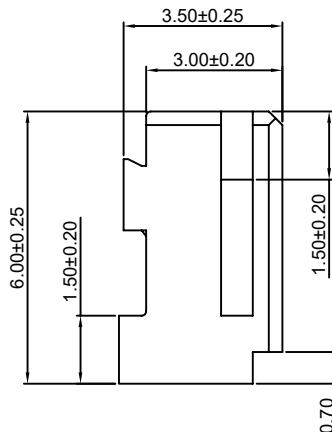
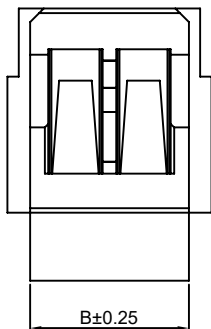
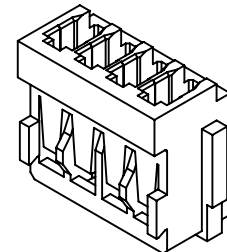

Ordering Information & Dimensions:

PART NO.	Dimensions	
	A	B
2P	1.50	3.50
3P	3.00	5.00
4P	4.50	6.50
5P	6.00	8.00
6P	7.50	9.50
7P	9.00	11.00
8P	10.50	12.50
9P	12.00	14.00
10P	13.50	15.50
11P	15.00	17.00
12P	16.50	18.50
13P	18.00	20.00
14P	19.50	21.50
15P	21.00	23.00
16P	22.50	24.50
17P	24.00	26.00
18P	25.50	27.50
19P	27.00	29.00
20P	28.50	30.50

Unit: mm

A1502WV-XP

1.50mm pitch 180° Wafer

Reference Informations:

- *Material:Pin:Brass/Tin over Nickel
Insulator:Nylon 66,UL94V-0
- *Mates with CJT A1502H-XP series Housing
- *Color:White

Ordering Information:

A1502WV-XP - *** - ** - **
1 2 3 4

- 1.Part No.
- 2.Material:
(Blank):Nylon 66,UL94V-0
GWT:Nylon 66,UL94V-0 GWT 750 °C
- 3.Color:
(blank):White
BK:Black
- 4.Finish:
(Blank):Tin over Nickel
G:Gold over Nickel

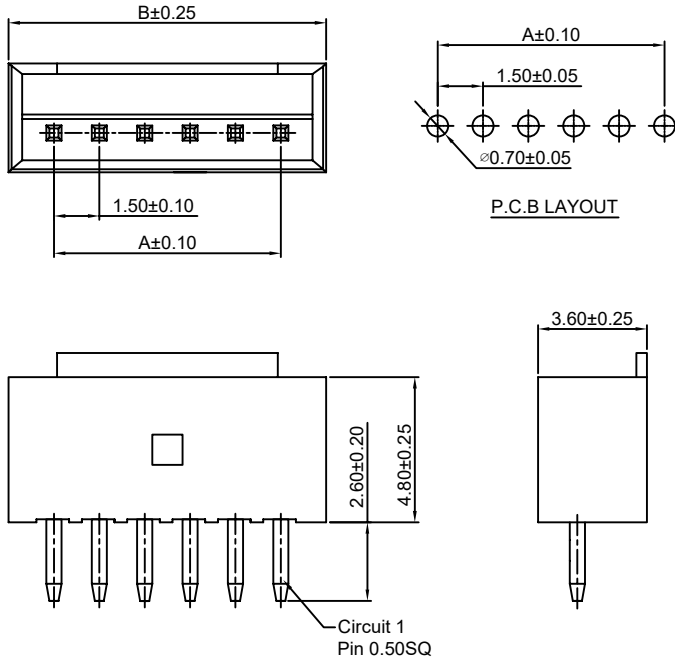

Ordering Information & Dimensions:

PART NO.	Dimensions	
	A	B
2P	1.50	4.50
3P	3.00	6.00
4P	4.50	7.50
5P	6.00	9.00
6P	7.50	10.50
7P	9.00	12.00
8P	10.50	13.50
9P	12.00	15.00
10P	13.50	16.50
11P	15.00	18.00
12P	16.50	19.50
13P	18.00	21.00
14P	19.50	22.50
15P	21.00	24.00

Unit: mm

A1502WR-XP

1.50mm pitch 90° Wafer

Reference Informations:

- *Material:Pin:Brass/Tin over Nickel
Insulator:Nylon 66,UL94V-0
- *Mates with CJT A1502H-XP series Housing
- *Color:White

Ordering Information:

A1502WR-XP - *** - ** - **
1 2 3 4

- 1.Part No.
- 2.Material:
(Blank):Nylon 66,UL94V-0
GWT:Nylon 66,UL94V-0 GWT 750 °C
- 3.Color:
(blank):White
BK:Black
- 4.Finish:
(Blank):Tin over Nickel
G:Gold over Nickel

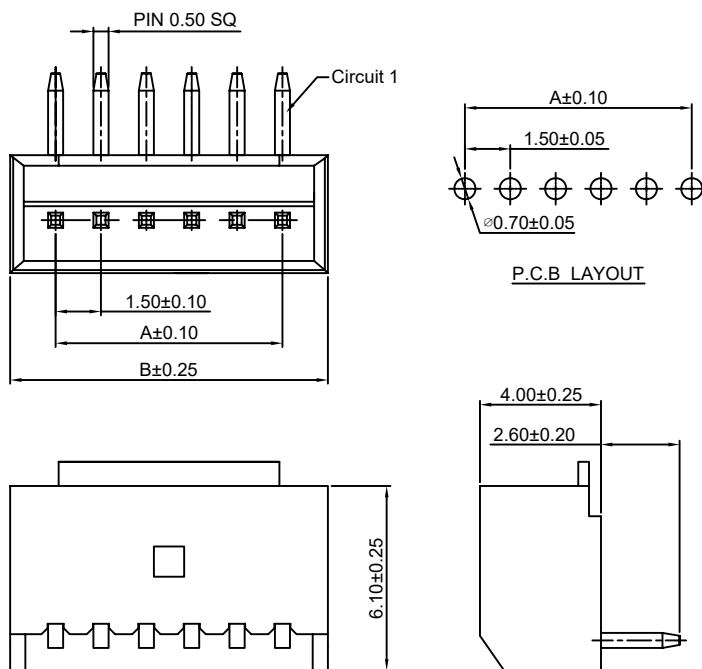

Ordering Information & Dimensions:

PART NO.	Dimensions	
	A	B
2P	1.50	4.50
3P	3.00	6.00
4P	4.50	7.50
5P	6.00	9.00
6P	7.50	10.50
7P	9.00	12.00
8P	10.50	13.50
9P	12.00	15.00
10P	13.50	16.50
11P	15.00	18.00
12P	16.50	19.50
13P	18.00	21.00
14P	19.50	22.50
15P	21.00	24.00

Unit: mm

A1502WV-S-XP

1.50mm pitch 180° Wafer-SMT TYPE

Reference Informations:

- *Material:Pin:Brass/Tin over Nickel
Insulator:Nylon 6T,UL94V-0
- *Mates with CJT A1502H-XP series Housing
- *Color:Ivory

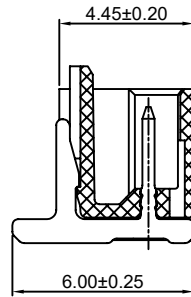
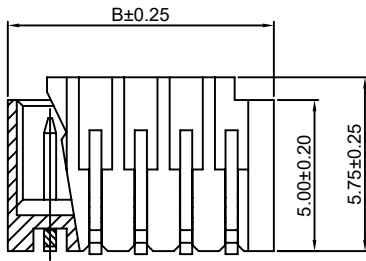
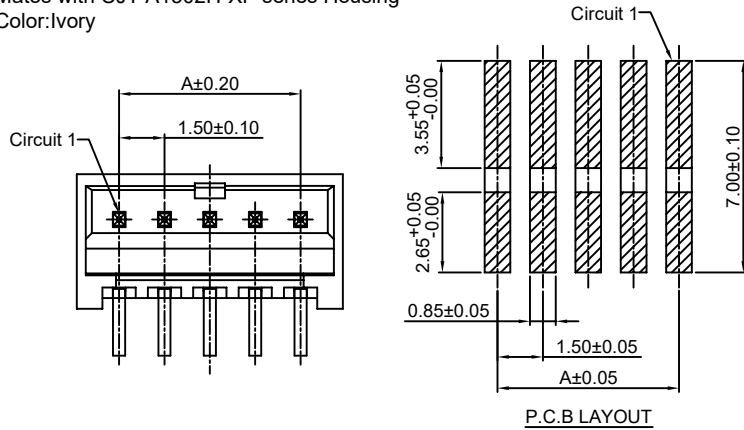

Ordering Information:

A1502WV-S-XP - ^{***}/₂ - ^{**}/₃ - ^{**}/₄

- 1.Part No.
- 2.Material:
(Blank):Nylon 66,UL94V-0
GWT:Nylon 66,UL94V-0,GWT 750°C
- 3.Color:
(blank):White
BK:Black
- 4.Finish:
(Blank):Tin over Nickel
G:Gold over Nickel

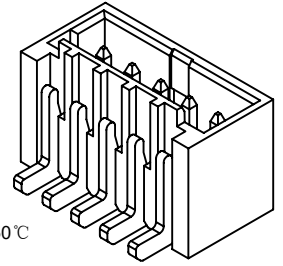

Ordering Information & Dimensions:

PART NO.	Dimensions	
	A	B
2P	1.50	4.30
3P	3.00	5.80
4P	4.50	7.30
5P	6.00	8.80
6P	7.50	10.30
7P	9.00	11.80
8P	10.50	13.30
9P	12.00	14.80
10P	13.50	16.30
11P	15.00	17.80
12P	16.50	19.30
13P	18.00	20.80
14P	19.50	22.30
15P	21.00	23.80

Unit: mm

A1502WR-S-XP

1.50mm pitch 90° Wafer-SMT TYPE

Reference Informations:

- *Material:Pin:Brass/Tin over Nickel
Insulator:Nylon 6T,UL94V-0
- *Mates with CJT A1502H-XP series Housing
- *Color:Ivory

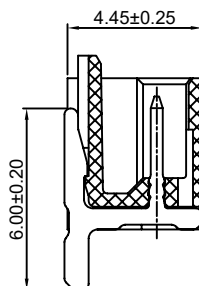
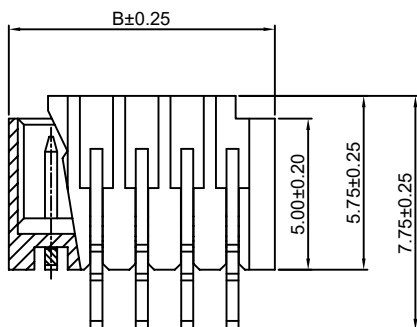
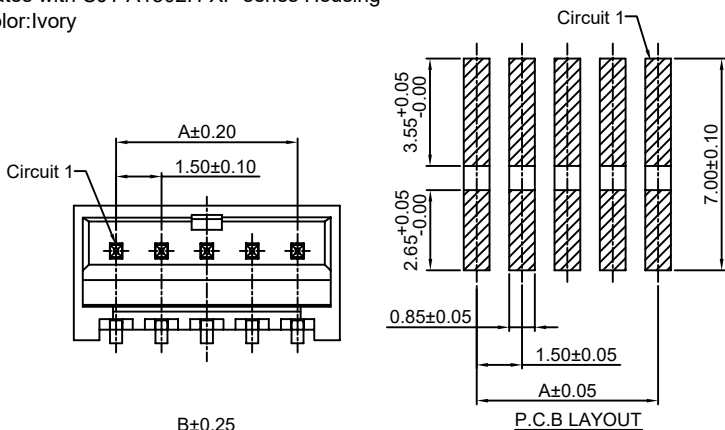

Ordering Information:

A1502WR-S-XP - ^{***}/₂ - ^{**}/₃ - ^{**}/₄

- 1.Part No.
- 2.Material:
(Blank):Nylon 66,UL94V-0
GWT:Nylon 66,UL94V-0,GWT 750°C
- 3.Color:
(blank):White
BK:Black
- 4.Finish:
(Blank):Tin over Nickel
G:Gold over Nickel

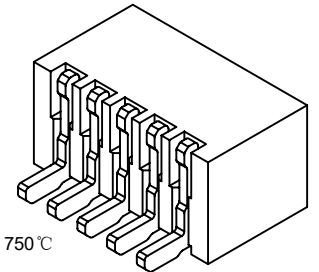

Ordering Information & Dimensions:

PART NO.	Dimensions	
	A	B
2P	1.50	4.30
3P	3.00	5.80
4P	4.50	7.30
5P	6.00	8.80
6P	7.50	10.30
7P	9.00	11.80
8P	10.50	13.30
9P	12.00	14.80
10P	13.50	16.30
11P	15.00	17.80
12P	16.50	19.30
13P	18.00	20.80
14P	19.50	22.30
15P	21.00	23.80

Unit: mm

A1502WVA-XP

1.50mm pitch 180° Wafer

Reference Informations:

- *Material:Pin:Brass/Tin over Nickel
Insulator:Nylon 66,UL94V-0
- *Mates with CJT A1502H-XP series Housing
- *Color:Gray

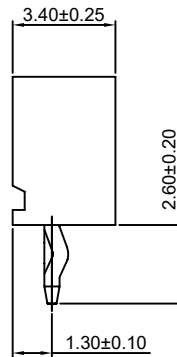
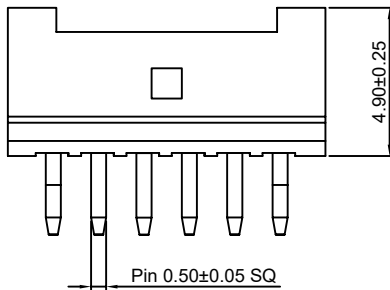
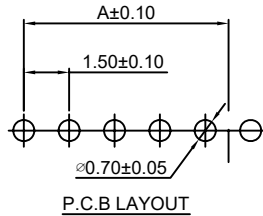
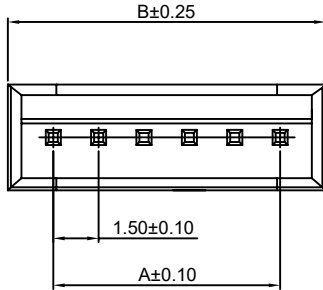

Ordering Information:

A1502WVA-XP - *** - **
1 2 3

- Part No.
- Material:
(Blank):Nylon 66,UL94V-0
GWT:Nylon 66,UL94V-0,GWT 750 °C
- Finish:
(Blank):Tin over Nickel
G:Gold over Nickel

Ordering Information & Dimensions:

PART NO.	Dimensions	
	A	B
2P	1.50	4.50
3P	3.00	6.00
4P	4.50	7.50
5P	6.00	9.00
6P	7.50	10.50
7P	9.00	12.00
8P	10.50	13.50
9P	12.00	15.00
10P	13.50	16.50
11P	15.00	18.00
12P	16.50	19.50
13P	18.00	21.00
14P	19.50	22.50
15P	21.00	24.00

Unit: mm

A1502WRA-XP

1.50mm pitch 90° Wafer

Reference Informations:

- *Material:Pin:Brass/Tin over Nickel
Insulator:Nylon 66,UL94V-0
- *Mates with CJT A1502H-XP series Housing
- *Color:Gray

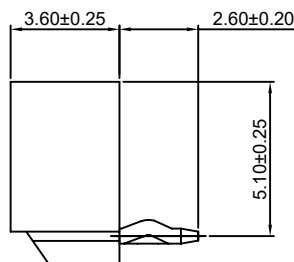
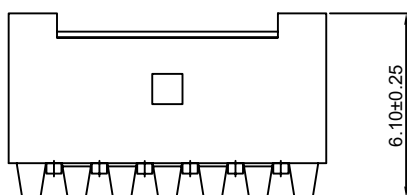
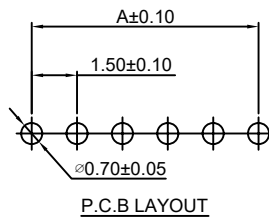
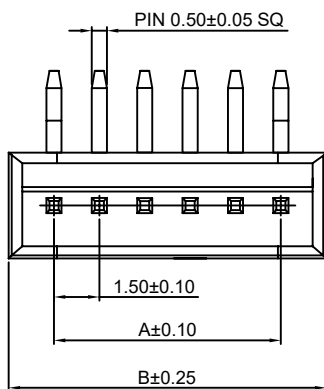

Ordering Information:

A1502WRA-XP - *** - **
1 2 3

- Part No.
- Material:
(Blank):Nylon 66,UL94V-0
GWT :Nylon 66,UL94V-0 GWT 750 °C
- Finish:
(Blank):Tin over Nickel
G:Gold over Nickel

Ordering Information & Dimensions:

PART NO.	Dimensions	
	A	B
2P	1.50	4.50
3P	3.00	6.00
4P	4.50	7.50
5P	6.00	9.00
6P	7.50	10.50
7P	9.00	12.00
8P	10.50	13.50
9P	12.00	15.00
10P	13.50	16.50
11P	15.00	18.00
12P	16.50	19.50
13P	18.00	21.00
14P	19.50	22.50
15P	21.00	24.00

Unit: mm

A1502WVA-IT-S-XP

1.50mm pitch thru board inverted SMT 180° Wafer

Reference Informations:

- *Material: Pin: Brass/Tin over Nickel
Solder Tabs: Brass/Tin over Nickel
Insulator: LCP, UL94V-0
- *Mates with CJT A1502HA-XP series Housing
- *Color: Ivory

Odering Information:

A1502WVA-IT-S-XP - *** - **
1 2 3

1. Part No.
2. Material:
(Blank): LCP, UL94V-0
GWT: LCP, UL94V-0, GWT 750 °C
3. Finish:
(Blank): Tin over Nickel
G: Gold over Nickel

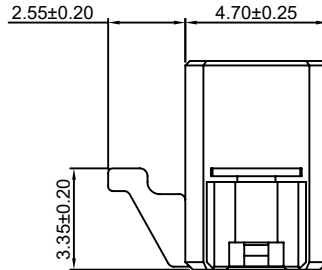
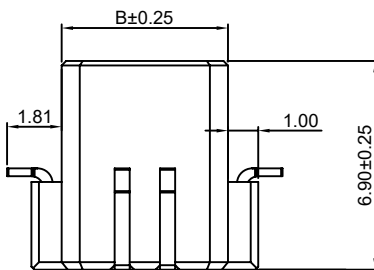
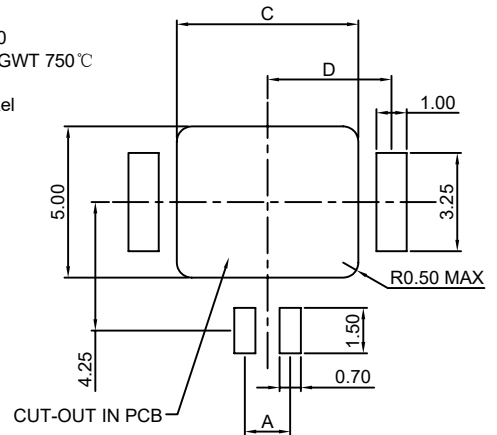
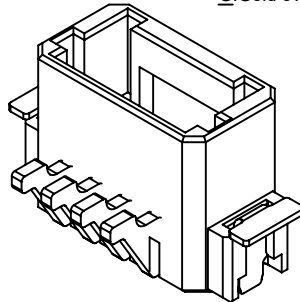
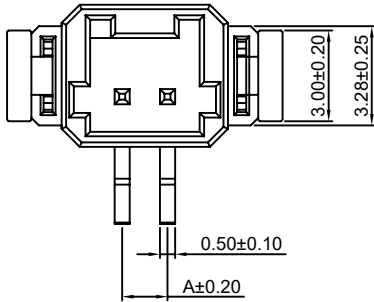

Ordering Information & Dimensions:

PART NO.	Dimensions			
	A	B	C	D
2P	1.50	5.50	6.00	4.10
3P	3.00	7.00	7.50	4.85
4P	4.50	8.50	9.00	5.60
5P	6.00	10.00	10.50	6.35
6P	7.50	11.50	12.00	7.10

Unit: mm