



CHT-LDOS

Preliminary datasheet
Version 1.0 (05/2006)

High-Temperature, 2.5V; 3.3V; 5V; 5.5V; 9V; 10V; 12V; 13V or 15V, 1A, Low-Dropout SOI-CMOS Voltage Regulator for symmetrical voltage applications.

General Description

The CHT-LDOS is a 1A, low-dropout linear voltage regulator compatible with high-temperature environments. Typical operation temperature range extends from -30°C to 225°C.

The circuit is stable throughout the whole temperature range and under a large choice of capacitive loads.

The minimum dropout voltage ($V_{in}-V_{out}$) is 2V with a 1A load current at 225°C and 1V for load currents lower than 400mA. The dropout voltage can span from 1 Volts to 20 Volts⁽¹⁾.

The circuit is a one-die solution.

CHT-LDOS is available in die and packages (currently TO-3 and TO-254) on demand.

Related documents:

- **AN-06016:** "Selecting correct CISSOID regulator depending on your application"
- **AN-06002:** "Voltage regulator short-circuit protection and associated potential startup problem".

Applications

Power supplies for high-temperature electronic systems used in Well logging, Automotive, Aeronautics or Aerospace applications.

Features

- 1V to 20V dropout Voltage @400mA⁽¹⁾
- 2V to 20V dropout Voltage @1A⁽¹⁾
- Max 1A output current @ 225°C
- 60dB input ripple rejection (0-100Hz)
- C_{load} from 100nF to 1000 μ F, large ESR range
- Available on die or in custom package on demand. (3-pins compatible)
- Stand-by mode available. (4-pins)
- Tungsten interconnects for long-term reliability
- The start-up is operative over the whole temperature range
- Latch-up free

Available voltages:

- CHT-LDOS-025: 2.5V
- CHT-LDOS-033: 3.3V
- CHT-LDOS-050: 5.0V
- CHT-LDOS-055 : 5.5V
- CHT-LDOS-090 : 9.0V
- CHT-LDOS-100 : 10.0V
- CHT-LDOS-120: 12.0V
- CHT-LDOS-130: 13.0V
- CHT-LDOS-150: 15.0V

Typical application

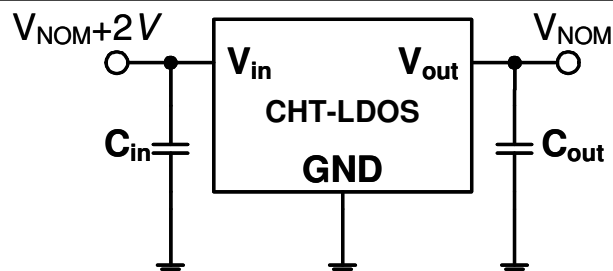

Absolute Maximum Ratings

Supply Voltage V_{in}	-0.3V...40V
Junction Temperature ⁽²⁾ (T_j)	315°C
Power dissipation ⁽³⁾	

Operating Conditions

Supply Voltage	1V to 20V dropout ⁽¹⁾
Junction temperature	-30°C to 225°C
Power Dissipation ⁽³⁾	

ESD Rating (expected)

Human Body Model	>1kV
------------------	------

Electrical Characteristics

Following table is relative to the 5V mode (CHT-LDOS-050).
For other nominal voltage, see notes under this table.

$V_{in} = V_{out} + 2V$

Parameter	Condition	Min	Typ	Max	Units	note
Output voltage accuracy	$I_L=10mA$ $-30^\circ C < T_j < 225^\circ C$	-2	0	2	%	
Output voltage T° drift	$I_L=10mA$ $25^\circ C < T_j < 225^\circ C$	0	40	80	ppm	(4)
Output voltage line regulation	dropout=2V to 15V $I_L=60mA, -30^\circ C < T_j < 225^\circ C$	-1		1	mV/V	(5)
Output voltage load regulation (i.e. R_{out})	$I_L=10mA$ to 1A @2V dropout $-30^\circ C < T_j < 225^\circ C$		0.04	0.1	V/A	(6)
(Vin-Vout) (dropout)	$I_L \leq 400mA, -30^\circ C < T_j < 225^\circ C$	1			V	
	$I_L=1A, -30^\circ C < T_j < 225^\circ C$	2			V	
Quiescent Ground Pin current	$0 < I_L < 1A$ $-30^\circ C$ $225^\circ C$		3.2 2.9		mA	(7)
Power supply rejection ratio	$f=0Hz \dots 100Hz$ $I_{load}=100mA$	tbd			dB	(8)
Foldback current			2.5		A	
Short-circuit current	$20^\circ C < T_j < 225^\circ C$		300		mA	
Output noise	10Hz-10kHz $I_L=100mA, -30^\circ C < T_j < 225^\circ C$		tbd		μV_{RMS}	

Notes:

- (1) $V_{in} \max=30V$
- (2) Above 225°C (T_j), a minimum load current of few mA could be required.
- (3) Max Power dissipation depends on packaging. CHT-LDOS in TO-3 or TO-254 packages presents a "junction-to-case" thermal resistance of maximum 5°C/W (R_{th}).
- (4) ppm are defined as $[d(V_{out})/d(T)]/V_{out}$. For 5V mode, 40ppm corresponds to 200 $\mu V/^\circ C$.
- (5) Defining "x" as the nominal voltage, the line regulation is better than x/5 mV/V.
- (6) This includes the packaging parasitic resistor.
- (7) Defining "x" as the nominal voltage, the typical quiescent current at 2V dropout can be approximated as 2.8+x/13 mA @ -30°C and 2.5+x/13 mA at 225°C.
- (8) Defining "x" as the nominal voltage, the minimum power supply rejection ratio is ...(tbd)....

Output Load, recommended specifications

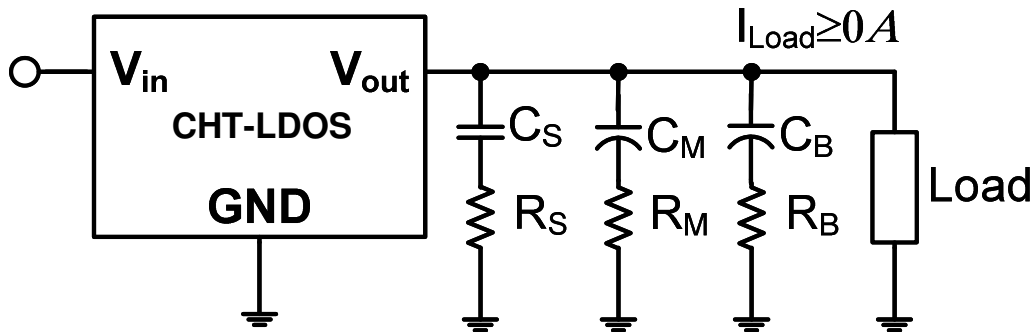

Resistances in series with capacitors represent the internal ESR of these capacitors.

For large capacitors:

$$C_B = 0 \text{ to } 1000\mu\text{F}$$

$$R_B = 0.2 \text{ to } \infty \Omega$$

For medium capacitors:

$$C_M = 0 \text{ to } 6\mu\text{F}$$

$$R_M = 0.1 \text{ to } 1 \Omega$$

For small Capacitors:

$$C_S = 100\text{n} \text{ to } 220\text{nF}$$

$$R_S = 10\text{m} \text{ to } 50\text{m} \Omega$$

Start-up conditions

The start-up is operative over the whole temperature range.

Refer to our application note for more details when using symmetrical voltages.

- **AN-06016:** "Selecting correct CISSOID regulator depending on your application"
- **AN-06002:** "Voltage regulator short-circuit protection and associated potential startup problem".

Measurements (CHT-LDOS-150)

Note: Temperatures hereafter are ambient temperatures, not junction temperatures.

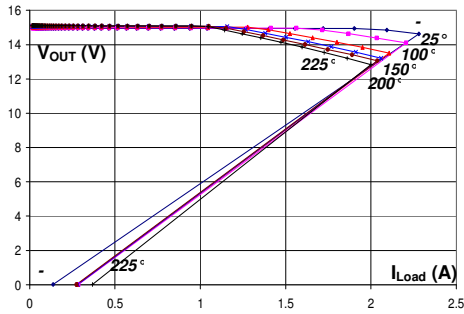

Figure 1: V_{out} vs. I_{Load} @ 2V dropout

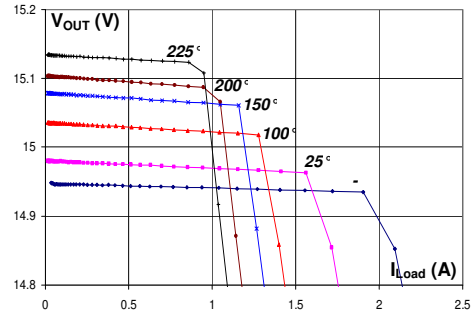

Figure 2: Zoom on figure 1

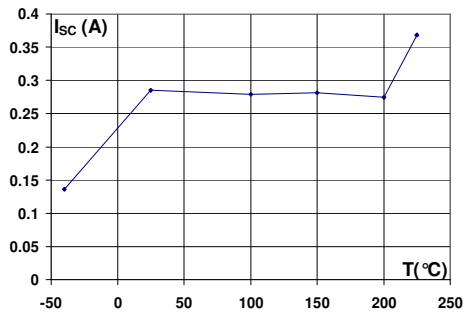

Figure 3: Typical short-circuit current vs. T°

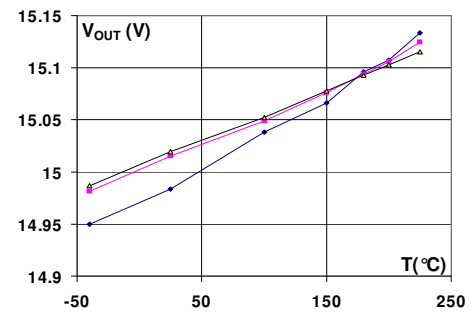

Figure 4: V_{out} vs. T° (2V dropout, 3 samples)

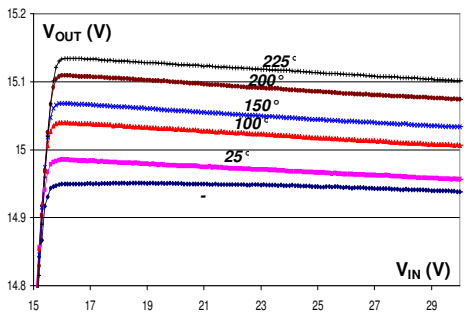

Figure 5: V_{out} vs. V_{in} over T°

Tbd
Should be very similar to CHT-LDO datasheet

Figure 6: Input ripple rejection

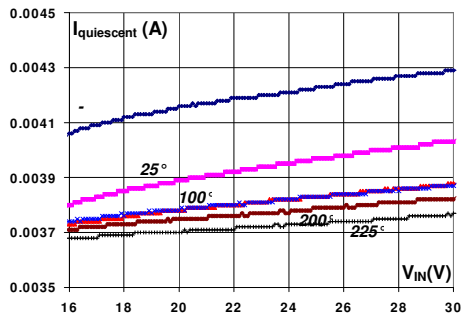

Figure 7: $I_{Quiescent}$ vs. V_{in} over T°

Tbd
Should be very similar to CHT-LDO datasheet

Figure 8: $S_{Vout}(V^2/Hz)$ @25°C, $I_{Load}=100mA$

Tbd

Should be very similar to CHT-LDO datasheet

Figure 9: Typical max load current over T° vs. dropout

AC rejection, noise and maximum load current vs. dropout measurements have not been performed yet on CHT-LDOS family. However, based on simulation results, measurements result should be very similar to those presented in our CHT-LDO family datasheet.

Available packaging and pinout.

TO-3: (Bottom View)

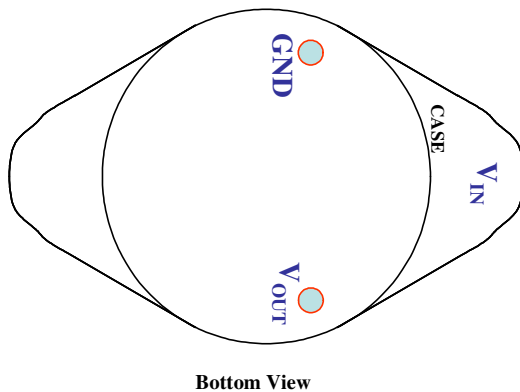

TO-254:

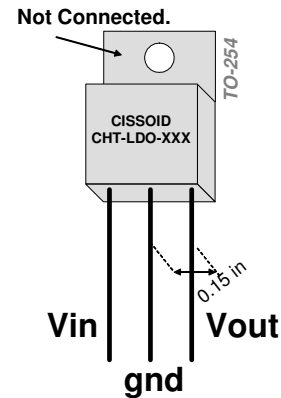

Contact & Ordering

CISSOID S.A.
Chemin du Cyclotron 6
1348 Louvain-la-Neuve
Belgium
Tel : +3210489210 sales@cissoid.com
Fax : +3210489219 <http://www.cissoid.com>

Product Reference : CHT-LDOS-XXX-YYYY

XXX= Output voltage. Example : 3.3V=033 ; 5V =050 ; 15V=150

YYYY=Package. TO3 or TO254 or DIE

Ex: CHT-LDOS-050-TO3 = 5V voltage regulator with TO3 package

Disclaimer

Neither CISSOID, nor any of its directors, employees or affiliates make any representations or extend any warranties of any kind, either express or implied, including but not limited to warranties of merchantability, fitness for a particular purpose, and the absence of latent or other defects, whether or not discoverable. In no event shall CISSOID, its directors, employees and affiliates be liable for direct, indirect, special, incidental or consequential damages of any kind arising out of the use of its circuits and their documentation, even if they have been advised of the possibility of such a damage. The circuits are provided "as is". CISSOID has no obligation to provide maintenance, support, updates, or modifications.