

INTEGRATED CONNECTOR MODULES

2 x n Multi-port Gigabit belStack™ with LEDs

BM02833

- Multi-port shielded RJ-45 connector with integrated Gigabit Ethernet magnetics
- Compatible with a variety of Gigabit Ethernet transceiver ICs and 10/100Base-TX transceiver ICs
- Operating temperature 0° to +70° C
- Storage temperature -40° to +85° C
- Complies with IEEE 802.3ab standards and all Gigabit Ethernet specifications
- Integrated design conserves valuable board space
- Minimum interwinding breakdown voltage of 1500 Vrms
- Adaptable, modular design provides higher reliability

ELECTRICAL SPECIFICATIONS AT 25° C

Part Number	Insertion Loss dB max	Return Loss dB min		Common to Differential Mode Rejection dB min	Common to Common Mode Rejection dB min	Crosstalk dB min	Hipot Vrms min
	0.1MHz to 100MHz	0.5MHz to 40MHz	40MHz to 100MHz	100KHz to 100MHz	100KHz to 100MHz		
0863-2H4R-54	-1.0	-18	12 - 20 log (f/80 MHz)	-35	-30	33 - 20 log (f/100MHz)	1500
0863-2H6R-54	-1.0	-18	12 - 20 log (f/80 MHz)	-35	-30	33 - 20 log (f/100MHz)	1500
0863-2H8R-54	-1.0	-18	12 - 20 log (f/80 MHz)	-35	-30	33 - 20 log (f/100MHz)	1500

Available Options

- Various transformer turns ratios
- Various high voltage capacitor values
- Various LED color combinations

BM02833

SCHEMATIC

0863-2H4R-54
 0863-2H6R-54
 0863-2H8R-54

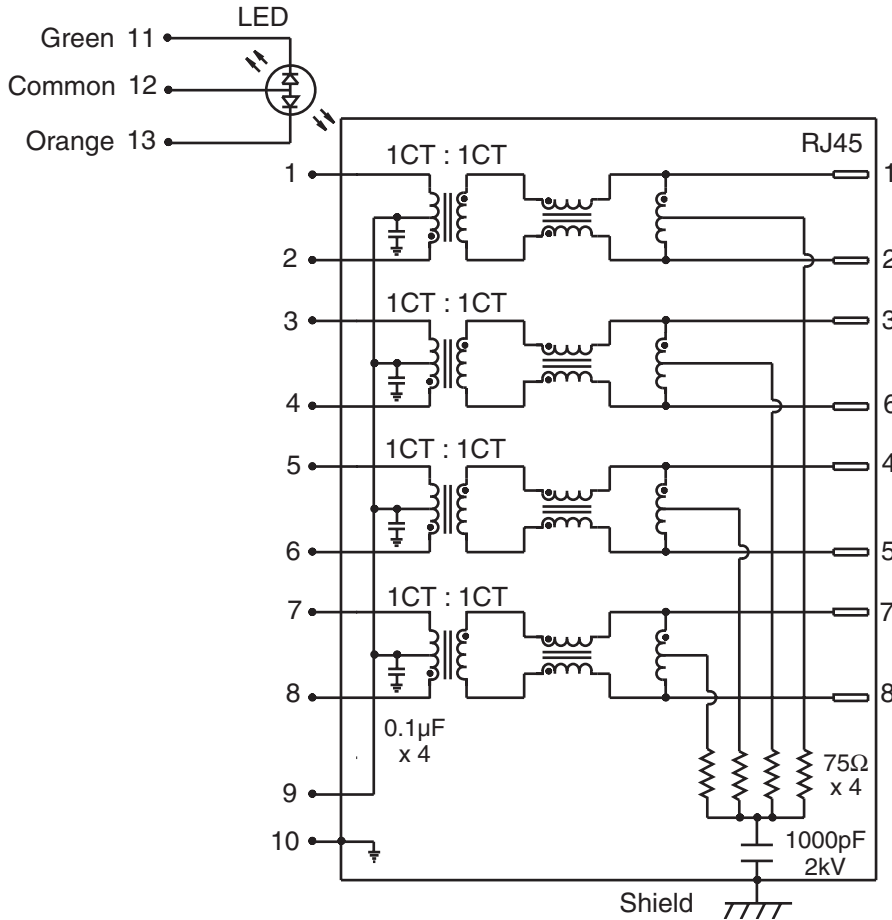

INTEGRATED CONNECTOR MODULES

2 x n Multi-port Gigabit belStack™ with LEDs

BM02833

MECHANICAL

0863-2H4R-54

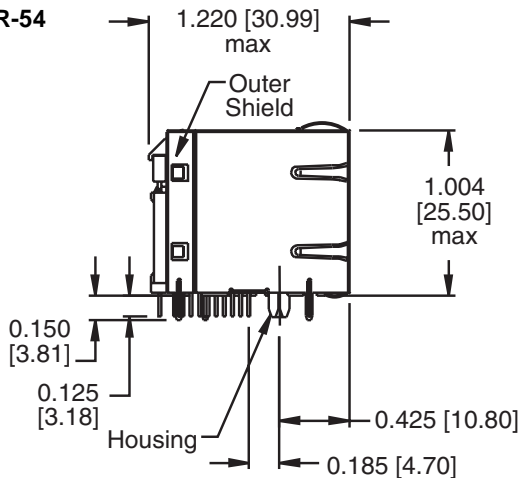

Dimensions are in inches [millimeters].
Standard dimension tolerance is ± 0.010 [0.25] unless otherwise noted.

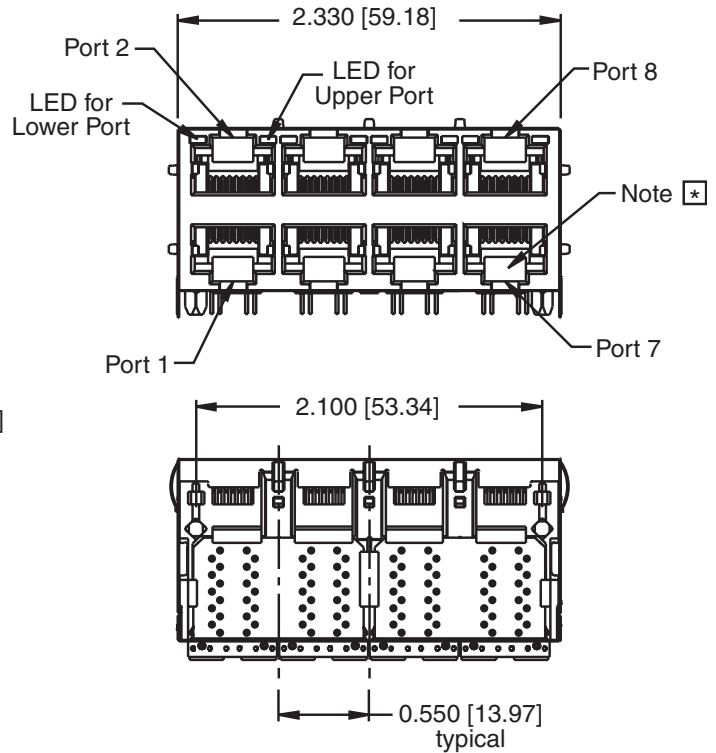

Notes

Plastic Housing	Thermoplastic, flammability rating UL 94V-0
Contacts	50 micro-inch hard gold plating
Pins	Tin-coated copper wire, DIA 0.018" [0.46]
Solderability	Per MIL Std. 202, Method 208
Metal Shield	Nickel plated copper alloy

Packing Quantity

20 pieces finished goods per tray
7 trays per carton box for a total of
140 pieces of finished goods

*Jack cavity conforms to FCC rules and regulations, part 68, subpart F.

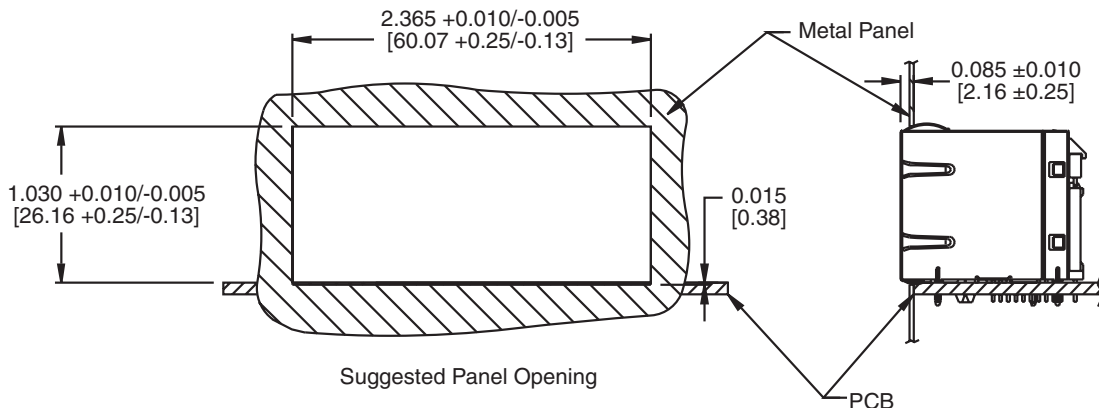

INTEGRATED CONNECTOR MODULES 2 x n Multi-port Gigabit belStack™ with LEDs

BM02833

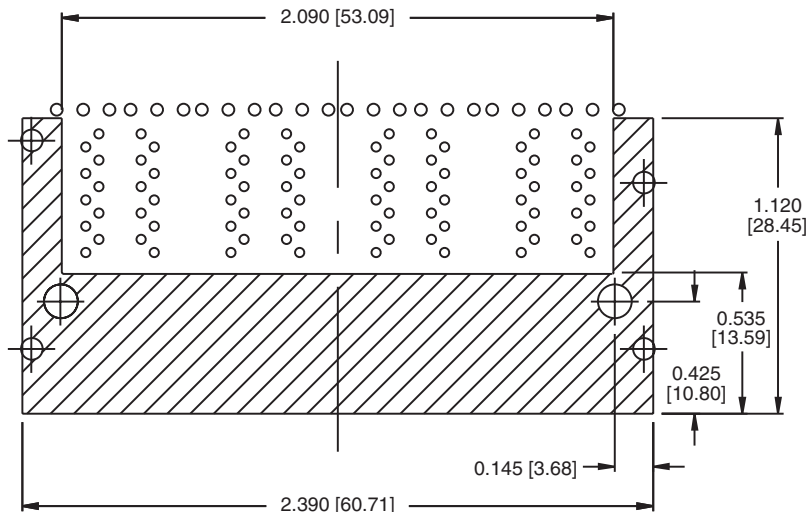
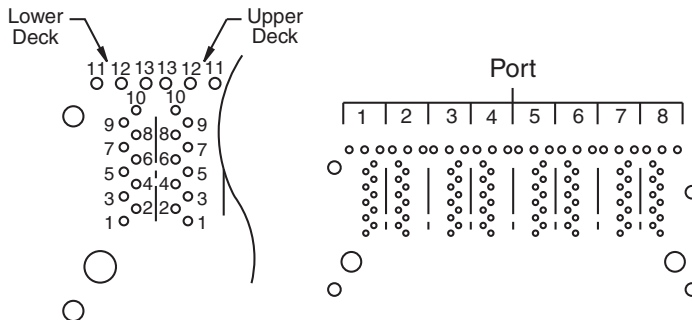
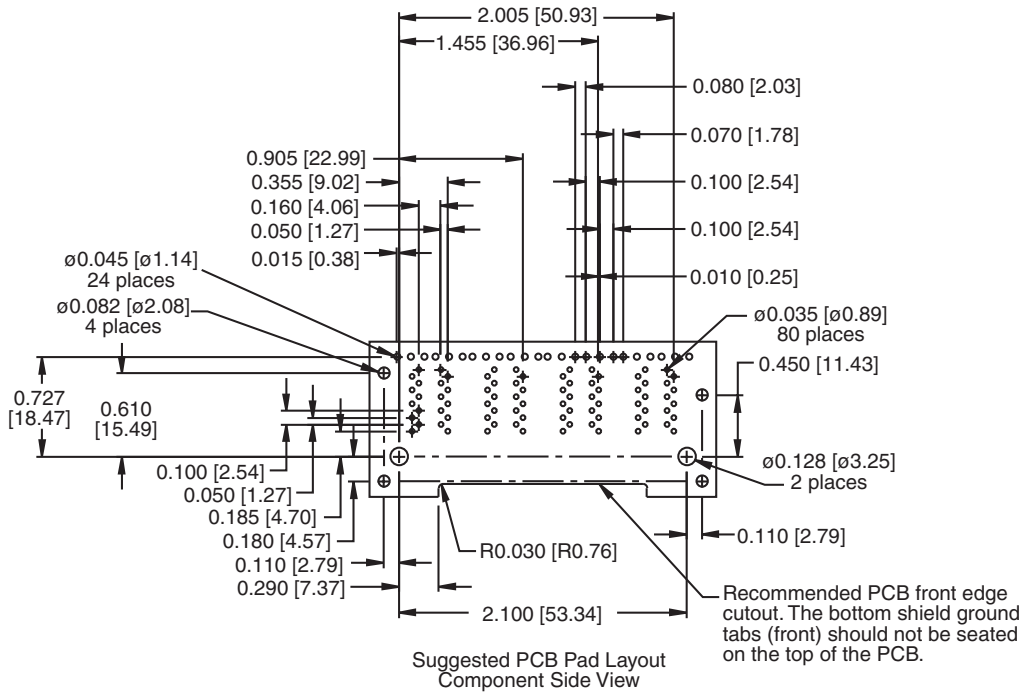

INTEGRATED CONNECTOR MODULES

2 x n Multi-port Gigabit belStack™ with LEDs

BM02833

MECHANICAL

0863-2H6R-54

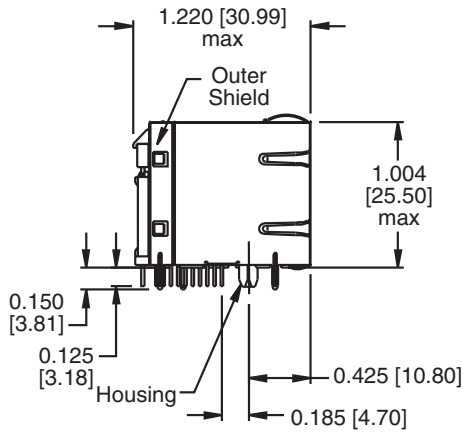

Dimensions are in inches [millimeters].
Standard dimension tolerance is ± 0.010 [0.25] unless otherwise noted.

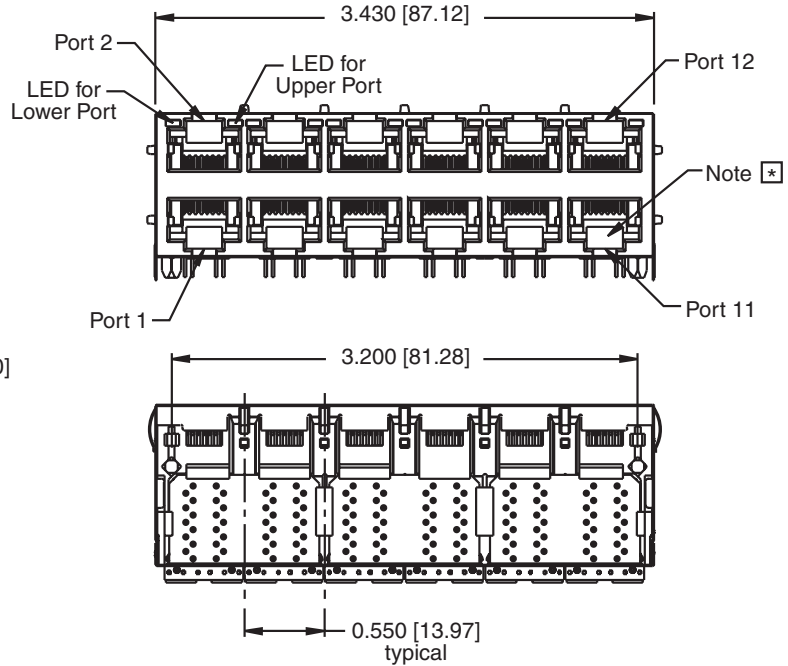

Notes

Plastic Housing	Thermoplastic, flammability rating UL 94V-0
Contacts	50 micro-inch hard gold plating
Pins	Tin-coated copper wire, DIA 0.018" [0.46]
Solderability	Per MIL Std. 202, Method 208
Metal Shield	Nickel plated copper alloy

Packing Quantity

15 pieces finished goods per tray
7 trays per carton box for a total of
105 pieces of finished goods

*Jack cavity conforms to FCC rules and regulations, part 68, subpart F.

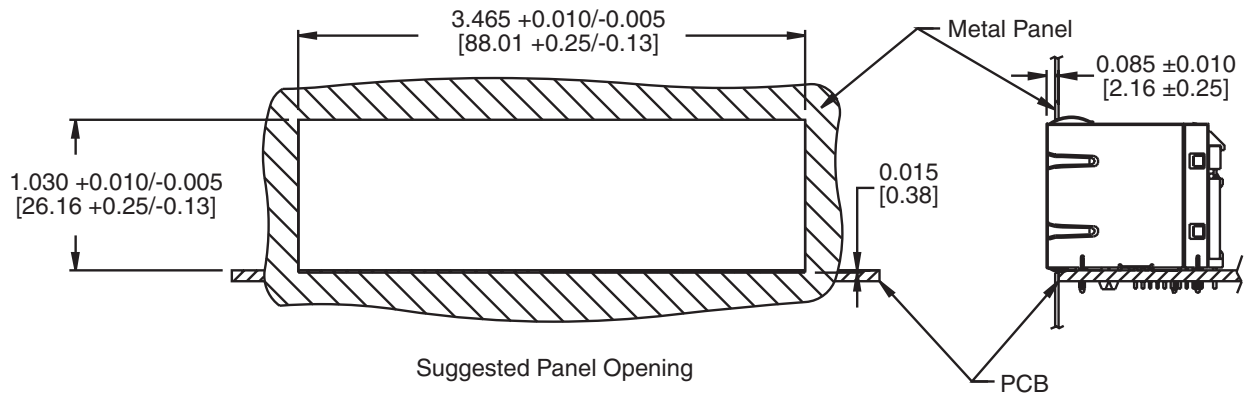

BM02833

PAD LAYOUT

0863-2H6R-54

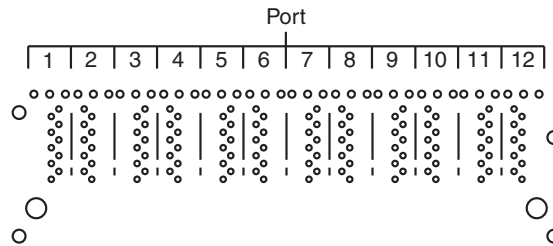
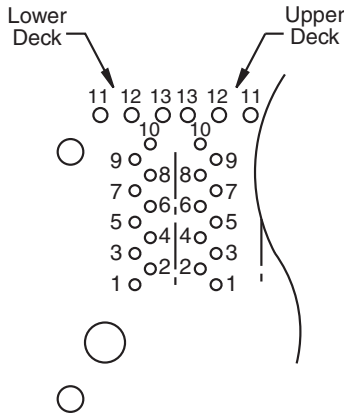
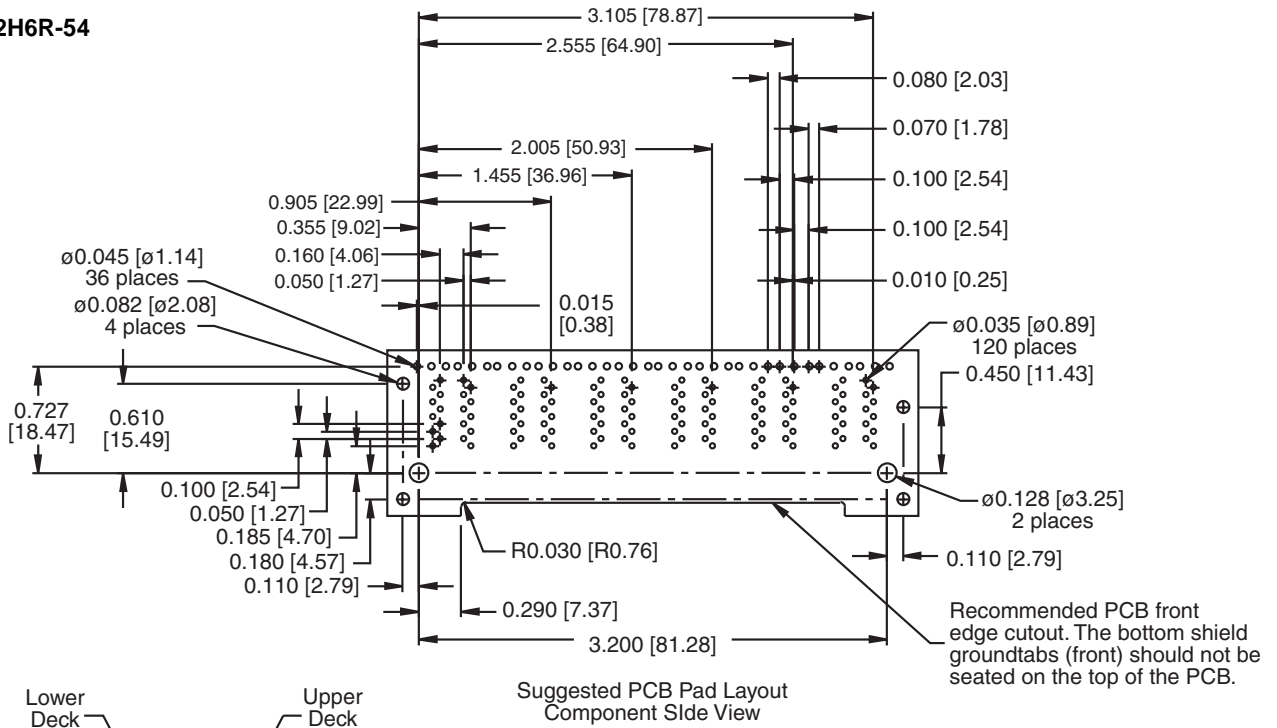

Notes

The shaded area of bottom side of part may be covered by metal shield.

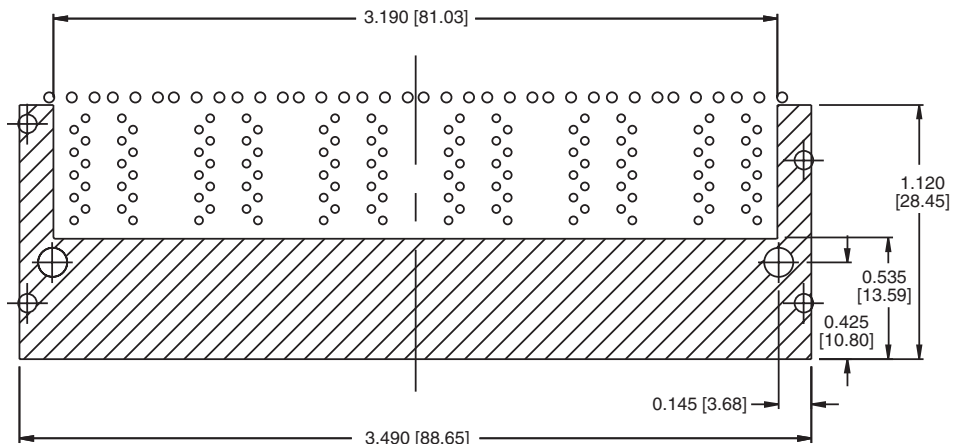

INTEGRATED CONNECTOR MODULES

2 x n Multi-port Gigabit belStack™ with LEDs

BM02833

MECHANICAL

0863-2H8R-54

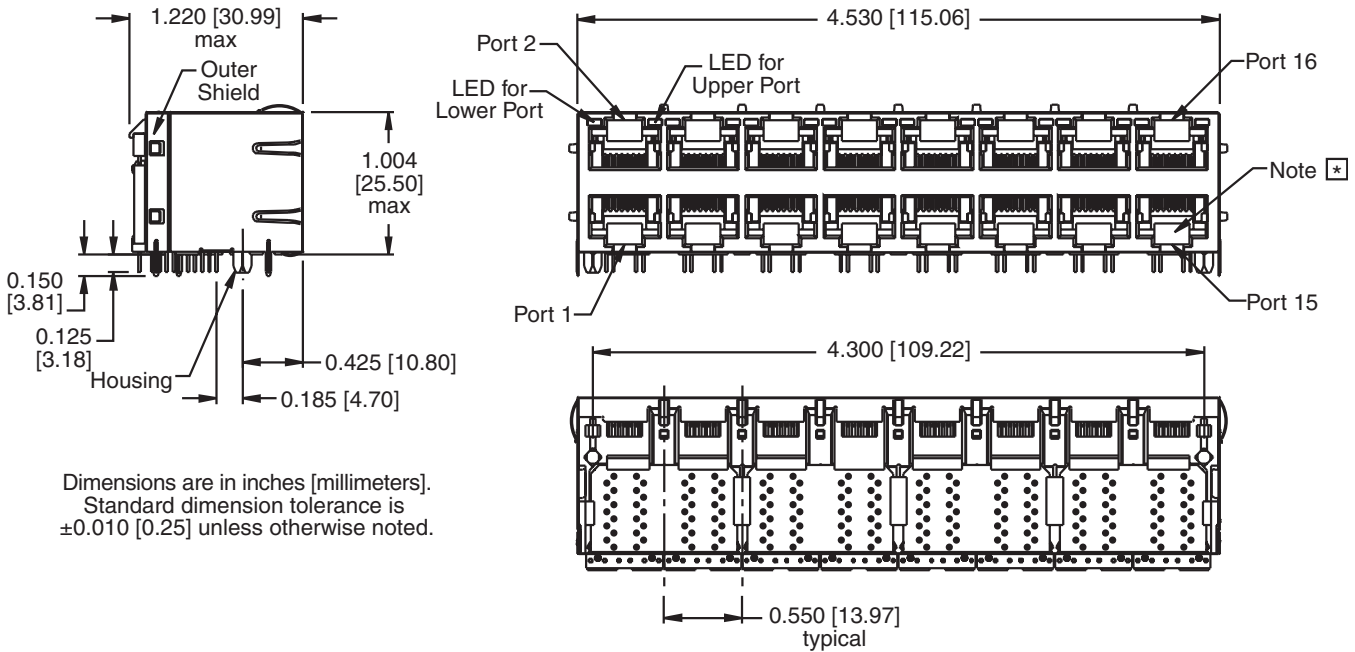

Dimensions are in inches [millimeters].
Standard dimension tolerance is ± 0.010 [0.25] unless otherwise noted.

Notes

Plastic Housing	Thermoplastic, flammability rating UL 94V-0
Contacts	50 micro-inch hard gold plating
Pins	Tin-coated copper wire, DIA 0.018" [0.46]
Solderability	Per MIL Std. 202, Method 208
Metal Shield	Nickel plated copper alloy

Packing Quantity

10 pieces finished goods per tray
7 trays per carton box for a total of
70 pieces of finished goods

* Jack cavity conforms to FCC rules and regulations, part 68, subpart F.

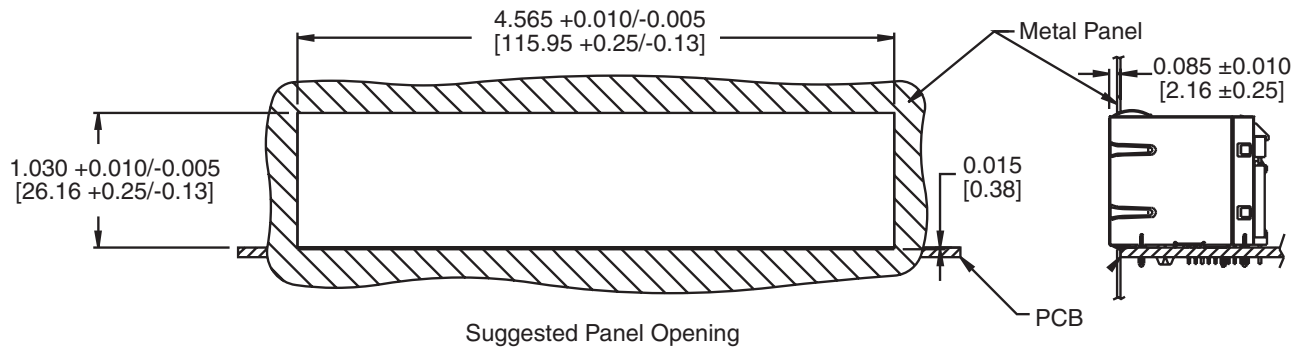

BM02833

PAD LAYOUT

0863-2H8R-54

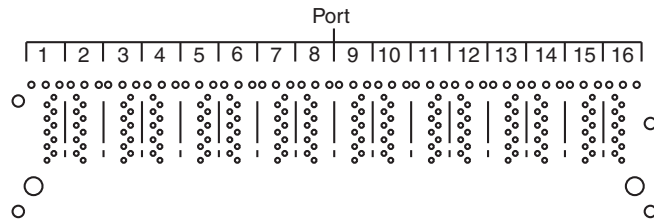
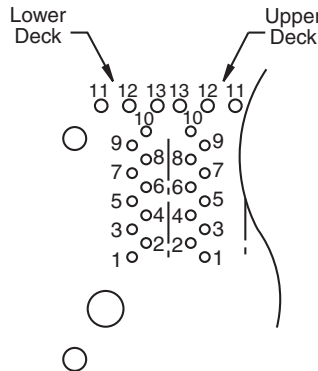
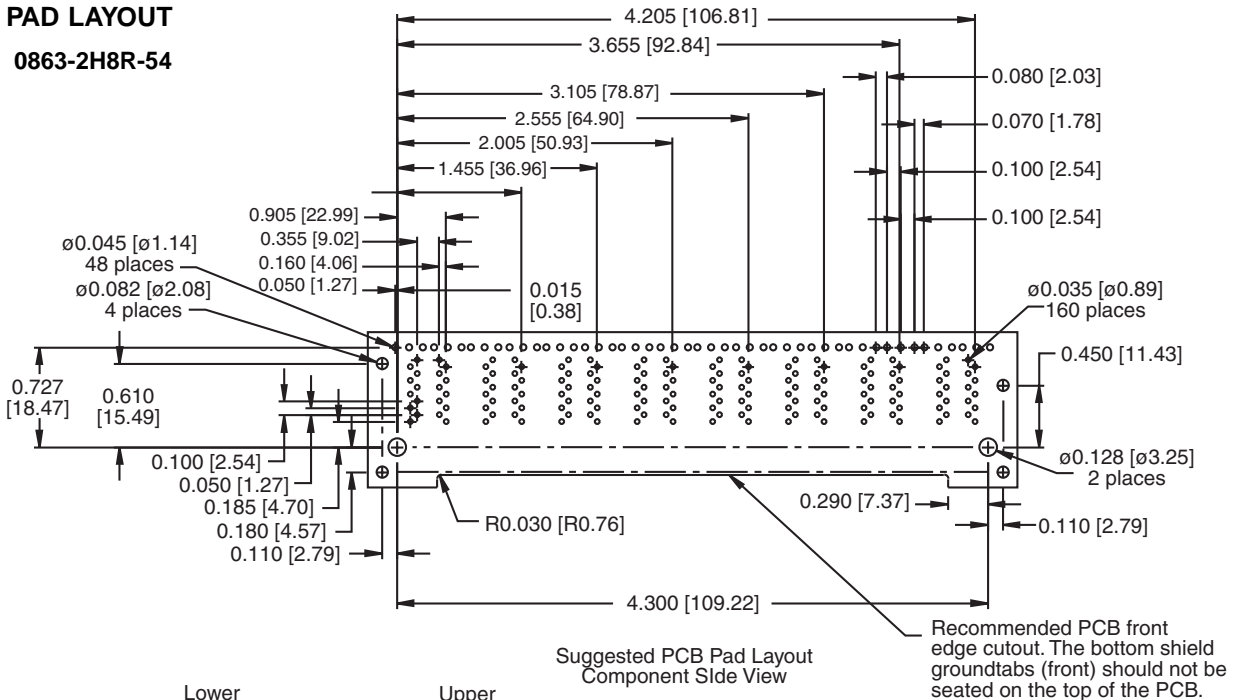

Notes

The shaded area of bottom side of part may be covered by metal shield.

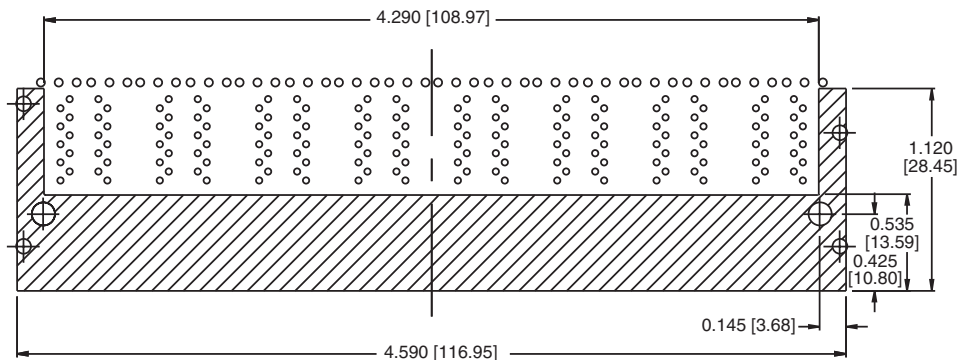

©2002 Bel Fuse Inc. Specifications subject to change without notice. 06.02

CORPORATE

Bel Fuse Inc.
206 Van Vorst Street
Jersey City, NJ 07302
Tel 201-432-0463
Fax 201-432-9542
www.belfuse.com

FAR EAST

Bel Fuse Ltd.
8F / 8 Luk Hop Street
San Po Kong
Kowloon, Hong Kong
Tel 852-2328-5515
Fax 852-2352-3706
www.belfuse.com

EUROPE

Bel Fuse Europe Ltd.
Preston Technology Management Centre
Marsh Lane, Suite G7, Preston
Lancashire, PR1 8UD, U.K.
Tel 44-1772-556601
Fax 44-1772-888366
www.belfuse.com