

■ Features

- Small Package
- Complementary to MMBT3906T

MARKING

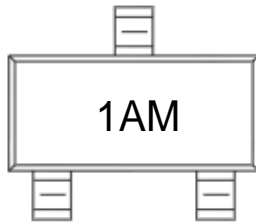

SOT - 23

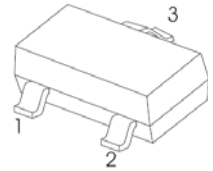

- 1. BASE
- 2. EMITTER
- 3. COLLECTOR

■ Absolute Maximum Ratings Ta = 25°C

Parameter	Symbol	Rating	Unit
Collector - Base Voltage	V _{CB0}	60	V
Collector - Emitter Voltage	V _{CE0}	40	
Emitter - Base Voltage	V _{EB0}	6	
Collector Current - Continuous	I _c	200	mA
Collector Power Dissipation	P _c	150	mW
Thermal Resistance, Junction to Ambient	R _{θJA}	833	°C/W
Junction Temperature	T _J	150	°C
Storage Temperature Range	T _{stg}	-55 to 150	

■ Electrical Characteristics Ta = 25°C

Parameter	Symbol	Test Conditions	Min	Typ	Max	Unit
Collector- base breakdown voltage	V _{CB0}	I _c = 100 μA, I _E = 0	60			V
Collector- emitter breakdown voltage	V _{CEO}	I _c = 1 mA, I _B = 0	40			
Emitter - base breakdown voltage	V _{EBO}	I _E = 100 μA, I _C = 0	6			
Collector-base cut-off current	I _{CBO}	V _{CB} = 60 V, I _E = 0			100	nA
Collector cut-off current	I _{CEx}	V _{CE} = 30 V, V _{EB(off)} =3V			50	
Emitter cut-off current	I _{EBO}	V _{EB} = 5V, I _C =0			100	
Collector-emitter saturation voltage	V _{CE(sat)}	I _C =10 mA, I _B =1mA			0.2	V
		I _C = 50 mA, I _B = 5mA			0.3	
Base - emitter saturation voltage	V _{BE(sat)}	I _C =10 mA, I _B =1mA	0.65		0.85	
		I _C = 50 mA, I _B = 5mA			0.95	
DC current gain	h _{FE(1)}	V _{CE} = 10V, I _C = 0.1mA	40			
	h _{FE(2)}	V _{CE} = 10V, I _C = 1mA	70			
	h _{FE(3)}	V _{CE} = 10V, I _C = 10mA	100		300	
	h _{FE(4)}	V _{CE} = 10V, I _C = 50mA	60			
Delay time	t _d	V _{CC} =3V, V _{BE(off)} =-0.5V I _C =10mA, I _{B1} =1mA			35	nS
Rise time	t _r				35	
Storage time	t _s	V _{CC} =3V, I _C =10mA, I _{B1} =I _{B2} =1mA			200	
Fall time	t _f				50	
Collector output capacitance	C _{ob}	V _{CB} = 5V, I _E = 0, f=1MHz			4	pF
Base input capacitance	C _{ib}	V _{EB} =0.5V, I _C =0, f=1MHz			8	
Transition frequency	f _T	V _{CE} = 20V, I _C = 10mA, f=100MHz	300			MHz

■ Typical Characteristics

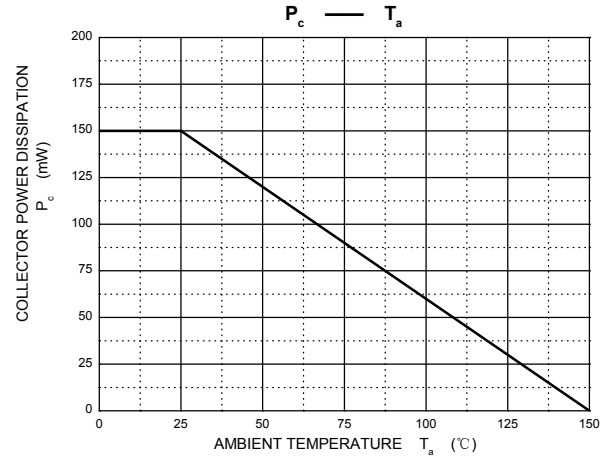
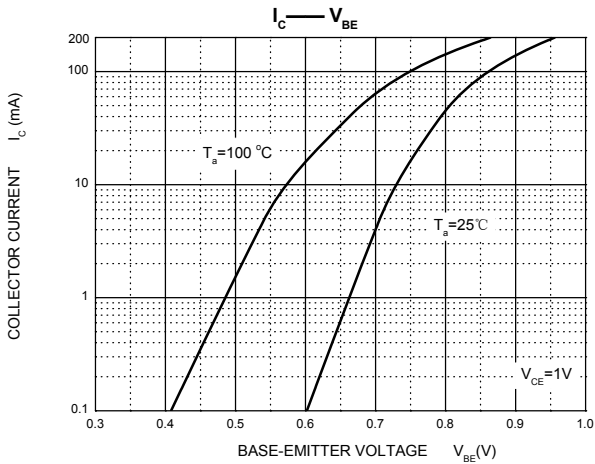
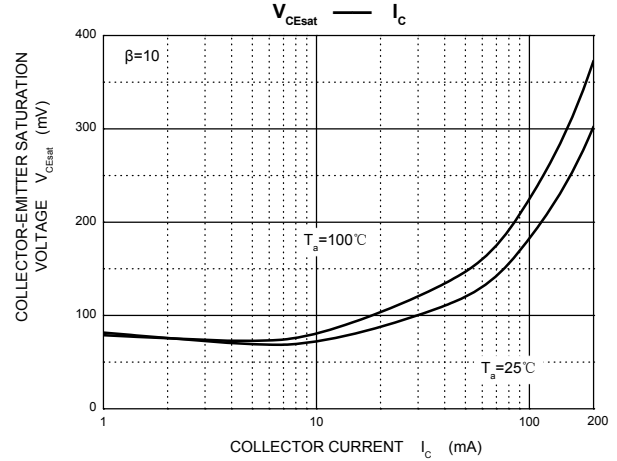
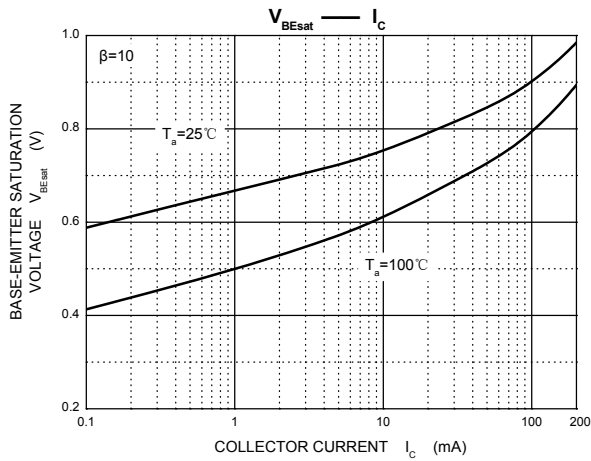
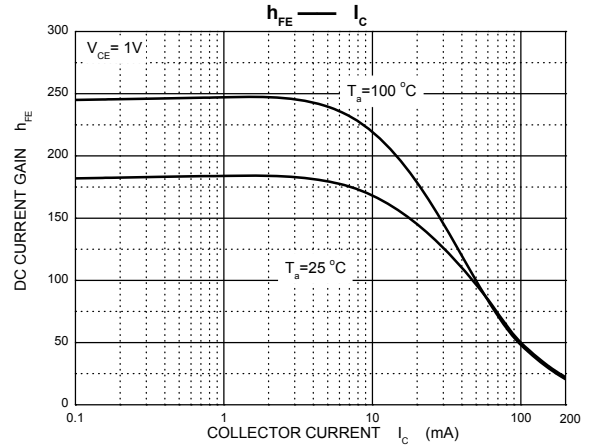
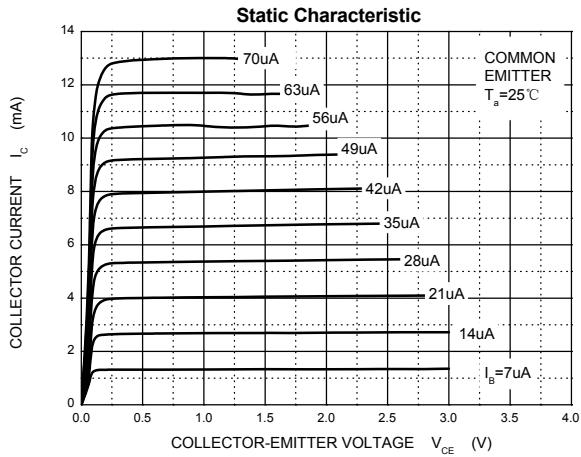

SOT-23 PACKAGE OUTLINE DIMENSIONS

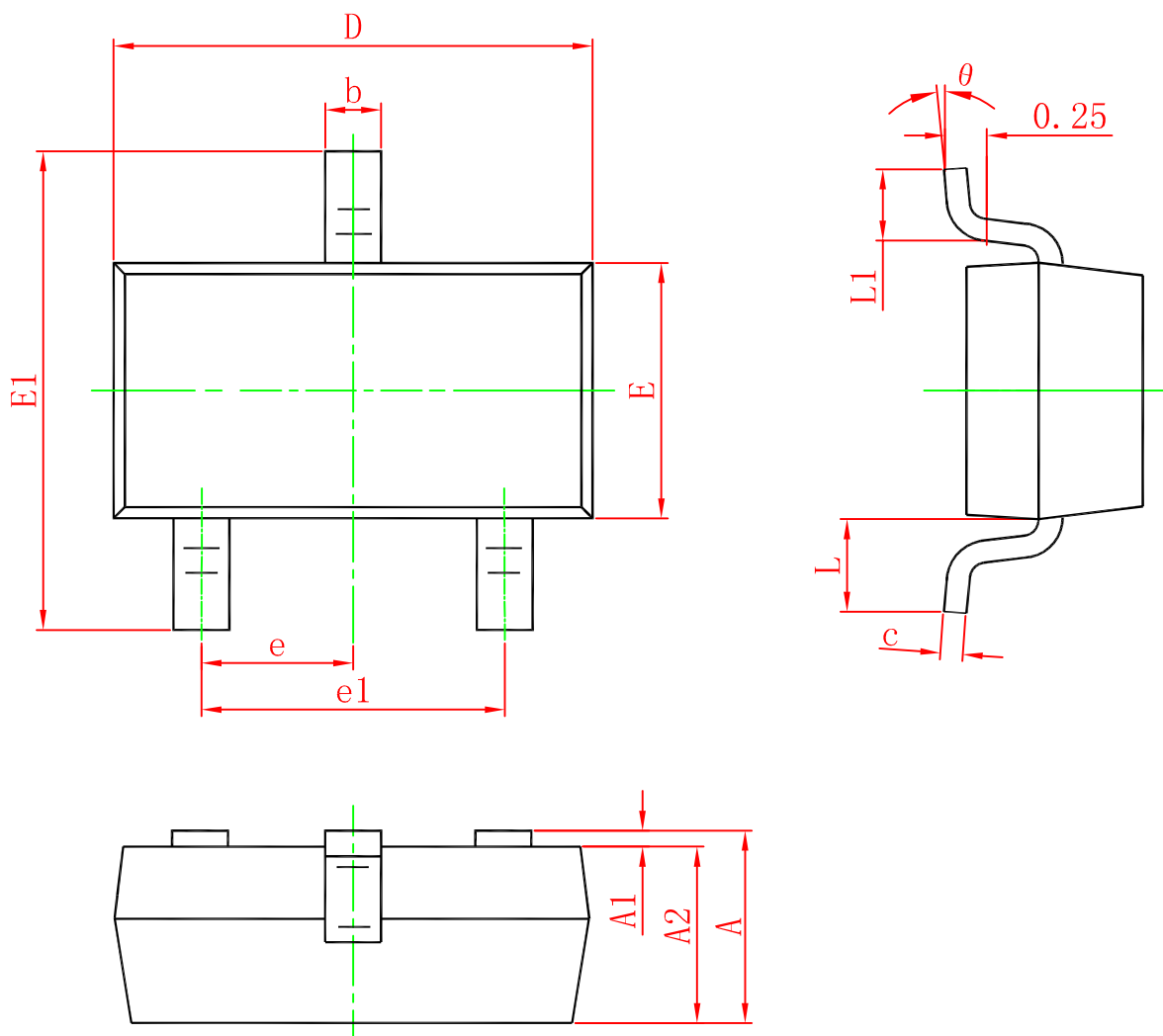

Symbol	Dimensions In Millimeters		Dimensions In Inches	
	Min.	Max.	Min.	Max.
A	0.900	1.150	0.035	0.045
A1	0.000	0.100	0.000	0.004
A2	0.900	1.050	0.035	0.041
b	0.300	0.500	0.012	0.020
c	0.080	0.150	0.003	0.006
D	2.800	3.000	0.110	0.118
E	1.200	1.400	0.047	0.055
E1	2.250	2.550	0.089	0.100
e	0.950 TYP.		0.037 TYP.	
e1	1.800	2.000	0.071	0.079
L	0.550 REF.		0.022 REF.	
L1	0.300	0.500	0.012	0.020
θ	0°	8°	0°	8°