

0.25-6 GHz High Dynamic Range Driver Amplifier

Features

- ✕ 17 dBm @ EVM = 2%
- ✕ 39 dBm Output IP3
- ✕ 25 dBm P1dB
- ✕ 10 dB Gain @ 5.8 GHz
- ✕ Single Supply Voltage, 5V ~ 8V
- ✕ 120 mA Current
- ✕ Single Input Matching
- ✕ 3X3mm QFN Package
- ✕ Ideal for WiMAX Applications @ 5.8 GHz

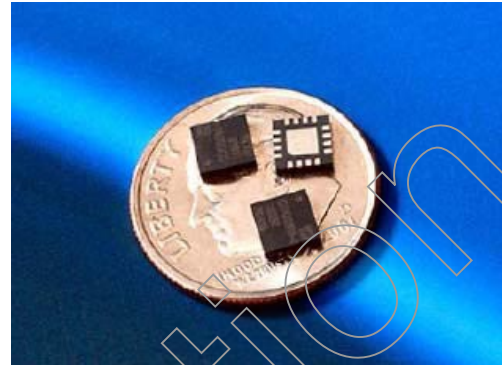

General Description

The XB1012-QT is a high dynamic range driver amplifier for applications within the 0.25 to 6 GHz frequency range. It is an ideal solution as a driver amplifier for the XP1044 in WiMAX applications at 5.8 GHz where excellent linear performance is desired. The XB1012-QT requires single positive supply only and minimum external matching. The device can be biased between 8V and 5V, yielding power levels at 1 dB compression between 23 dBm and 25 dBm.

Absolute Maximum Ratings

Supply Voltage	+9.0V
RF Input Power	+18 dBm
Storage Temperature	-55°C to 125°C
Junctions Temperature	175°C
Operating Temperature	-40°C to 85°C
Thermal Resistance	55°C/W

Operating this device beyond any of these parameters may cause permanent damage.

Electrical Characteristics (T=25 °C, Voltage Supply=8V, 5.8 GHz)

Unless otherwise specified, the following specifications are guaranteed at room temperature in a Mimix test fixture

Parameter	Condition	Units	Min	Typ	Max
Frequency Range		GHz	0.1		6.0
Power Gain		dB	10.0	10.5	
Linear Power	@ EVM = 2.0%, OFDM, 802.16 PAR = 9 dB	dBm	16.0	17.0	
Input Return Loss		dB	-10.0		
Output IP3 @ 5 dBm/Tone		dBm	38.0	39.0	
Noise Figure		dB		4.0	
Output P1 dB		dBm		25.0	
Operating Current Range		mA		120	
Supply Voltage		V	5.0	8.0	

0.25-6 GHz High Dynamic Range Driver Amplifier

December 2007 - Rev 20-Dec-07

Typical Performance (5.8 GHz)

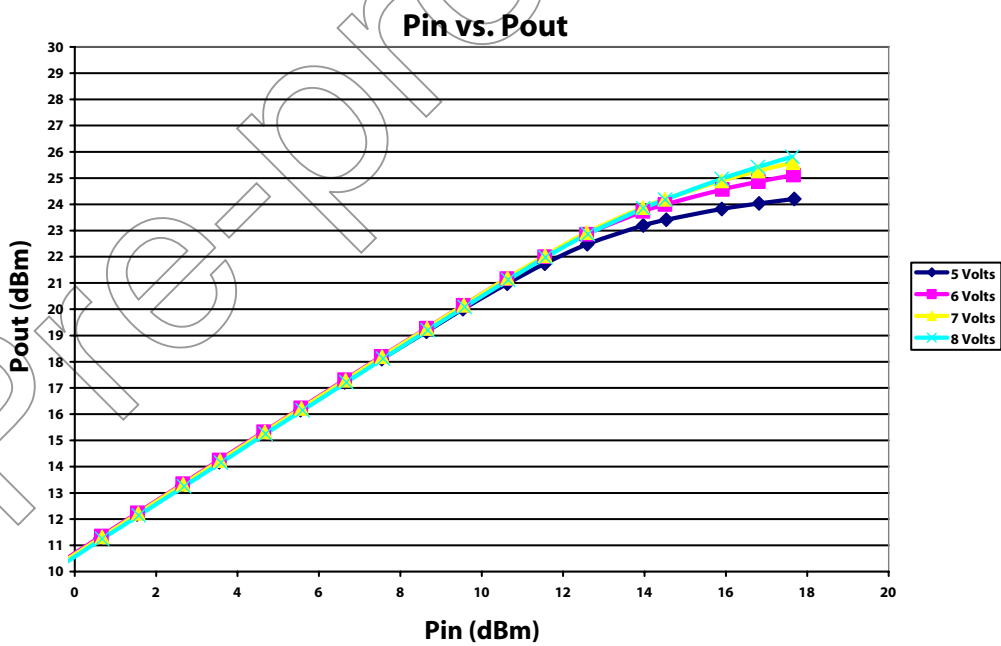
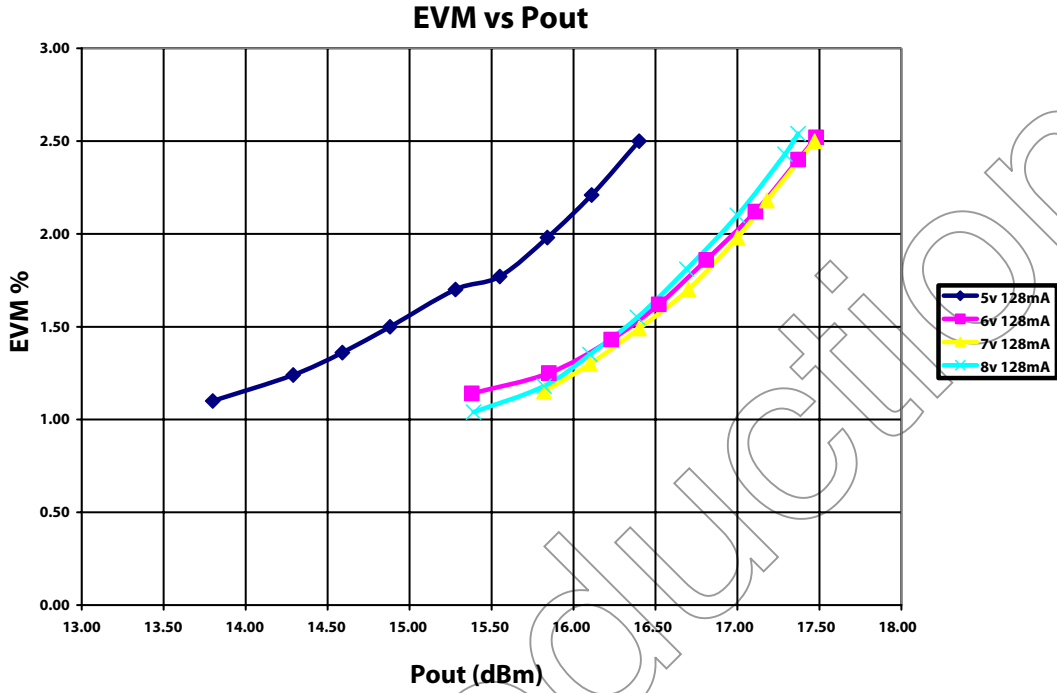

0.25-6 GHz High Dynamic Range Driver Amplifier

December 2007 - Rev 20-Dec-07

Typical Performance (5.8 GHz) (cont.)

Noise Figure

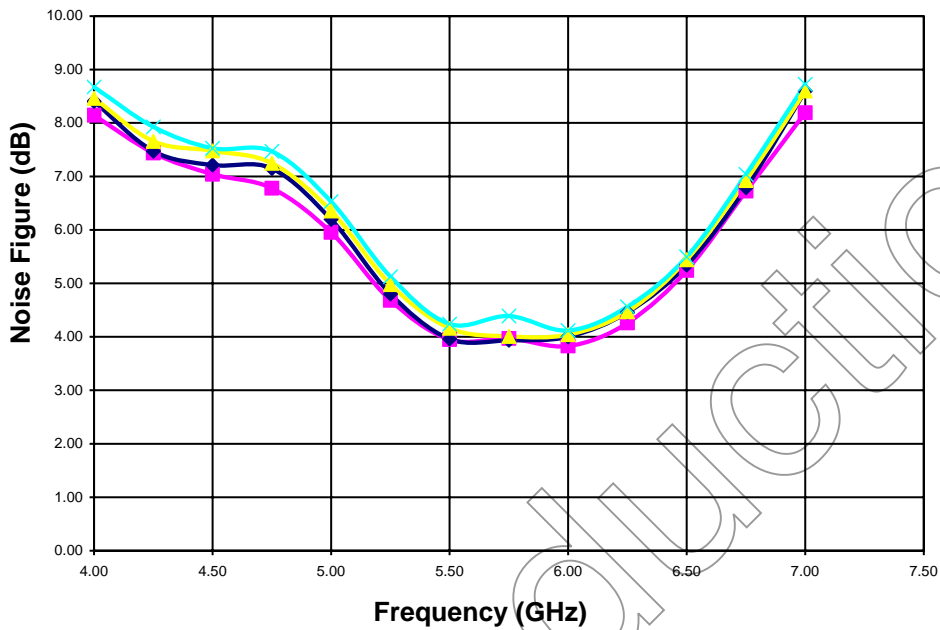

OIP3 vs. Pout

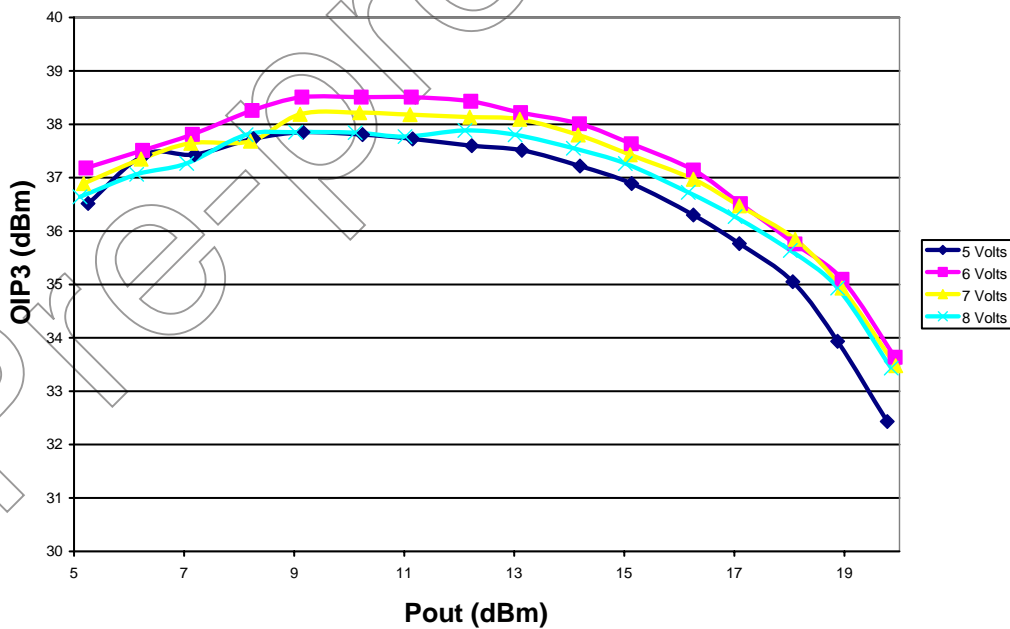

0.25-6 GHz High Dynamic Range Driver Amplifier

December 2007 - Rev 20-Dec-07

Physical Dimensions

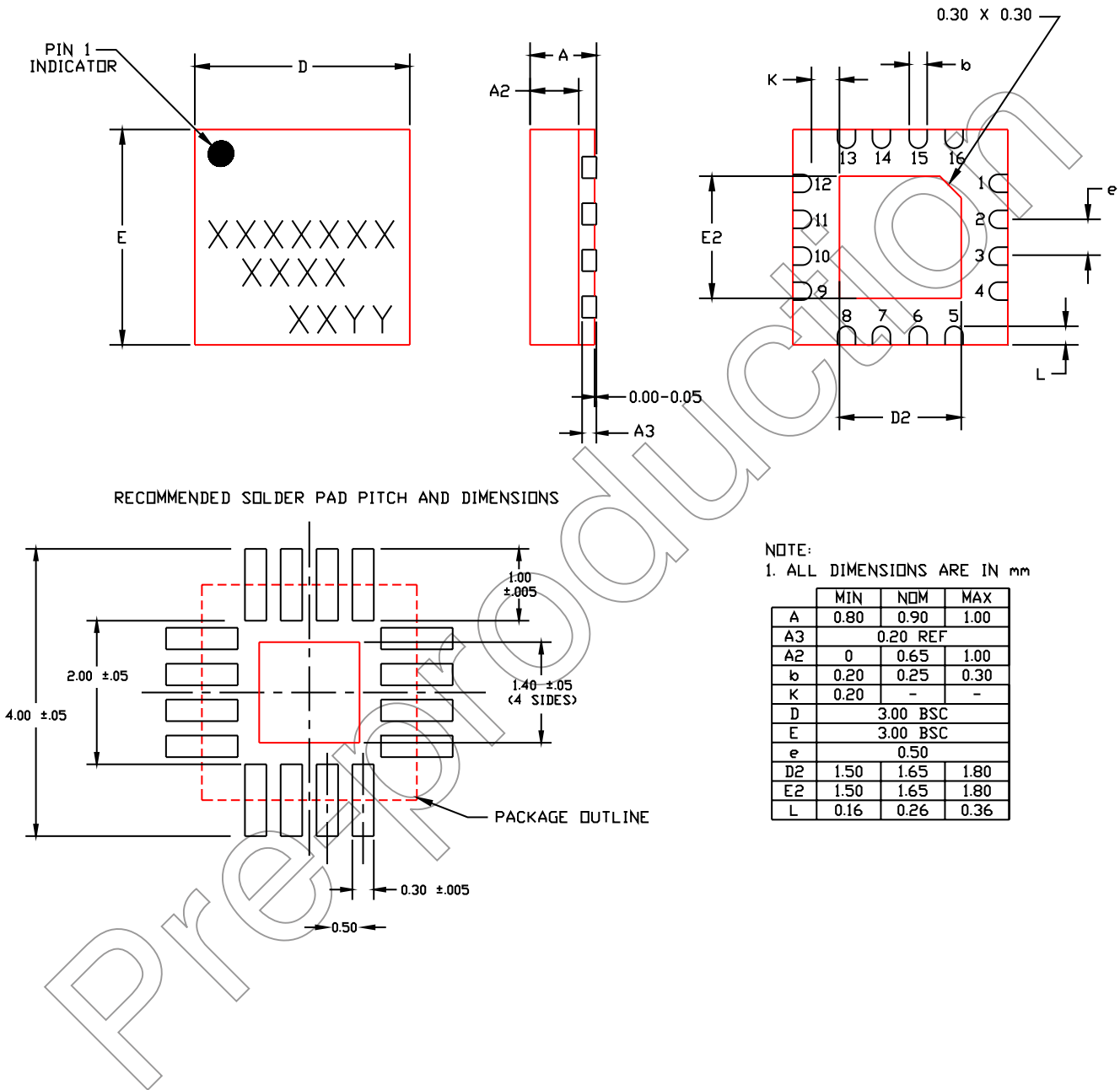

0.25-6 GHz High Dynamic Range Driver Amplifier

Application Circuit Schematic @ 5.8 GHz

Component List	
C1	0.3pf AVX ACCU-P 0402
C2	0.3pf AVX ACCU-P 0402
C3	0.3pf AVX ACCU-P 0402
C4	1000pF Murata 0402
C5	1uf Murata 0603
L1	6.8nH Murata LQW 0402

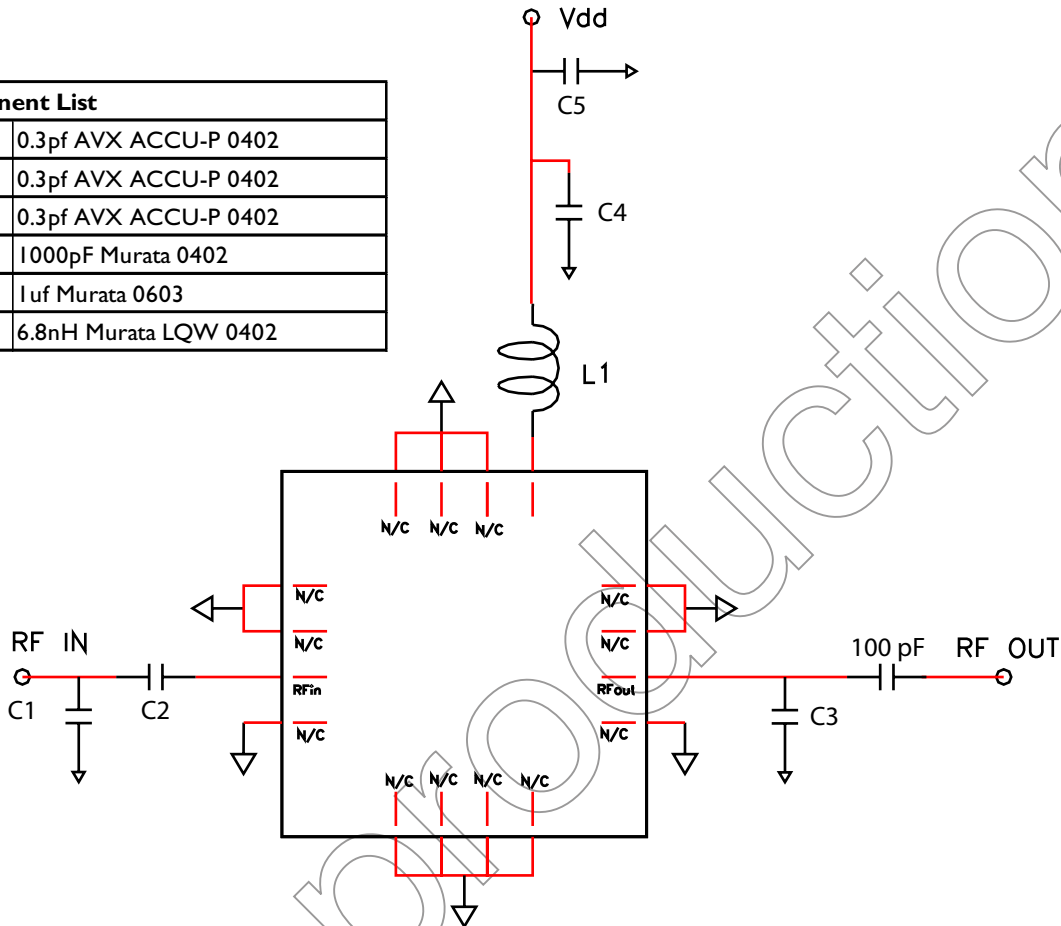

0.25-6 GHz High Dynamic Range Driver Amplifier

December 2007 - Rev 20-Dec-07

Handling and Assembly Information

CAUTION! - Mimix Broadband MMIC Products contain gallium arsenide (GaAs) which can be hazardous to the human body and the environment. For safety, observe the following procedures:

- Do not ingest.
- Do not alter the form of this product into a gas, powder, or liquid through burning, crushing, or chemical processing as these by-products are dangerous to the human body if inhaled, ingested, or swallowed.
- Observe government laws and company regulations when discarding this product. This product must be discarded in accordance with methods specified by applicable hazardous waste procedures.

Life Support Policy - Mimix Broadband's products are not authorized for use as critical components in life support devices or systems without the express written approval of the President and General Counsel of Mimix Broadband. As used herein: (1) Life support devices or systems are devices or systems which, (a) are intended for surgical implant into the body, or (b) support or sustain life, and whose failure to perform when properly used in accordance with instructions for use provided in the labeling, can be reasonably expected to result in a significant injury to the user. (2) A critical component is any component of a life support device or system whose failure to perform can be reasonably expected to cause the failure of the life support device or system, or to affect its safety or effectiveness.

Package Attachment - This packaged product from Mimix Broadband is provided as a rugged surface mount package compatible with high volume solder installation. Care should be taken not to apply heavy pressure to the top or base material to avoid package damage. Vacuum tools or other suitable pick and place equipment may be used to pick and place this part. Care should be taken to ensure that there are no voids or gaps in the solder connection so that good RF, DC and ground connections are maintained. Voids or gaps can eventually lead not only to RF performance degradation, but reduced reliability and life of the product due to thermal stress.

Mimix Lead-Free RoHS Compliant Program - Mimix has an active program in place to meet customer and governmental requirements for eliminating lead (Pb) and other environmentally hazardous materials from our products. All Mimix RoHS compliant components are form, fit and functional replacements for their non-RoHS equivalents. Lead plating of our RoHS compliant parts is 100% matte tin (Sn) over copper alloy and is backwards compatible with current standard SnPb low-temperature reflow processes as well as higher temperature (260°C reflow) "Pb Free" processes.

Ordering Information

Part Number	Description
XB1012-QT-0G00	Matte Tin plated RoHS compliant 3x3 QFN package in bulk quantity
XB1012-QT-0G0T	Matte Tin plated RoHS compliant 3x3 QFN package in tape and reel
XB1012-QT-EV1	Evaluation Board @ 5.8 GHz



Proper ESD procedures should be followed when handling this device.

Mimix Broadband, Inc., 10795 Rockley Rd., Houston, Texas 77099
Tel: 281.988.4600 Fax: 281.988.4615 mimixbroadband.com

Page 6 of 6