

NEW

High Current, High Density, Power Connectors

MCN51 Series

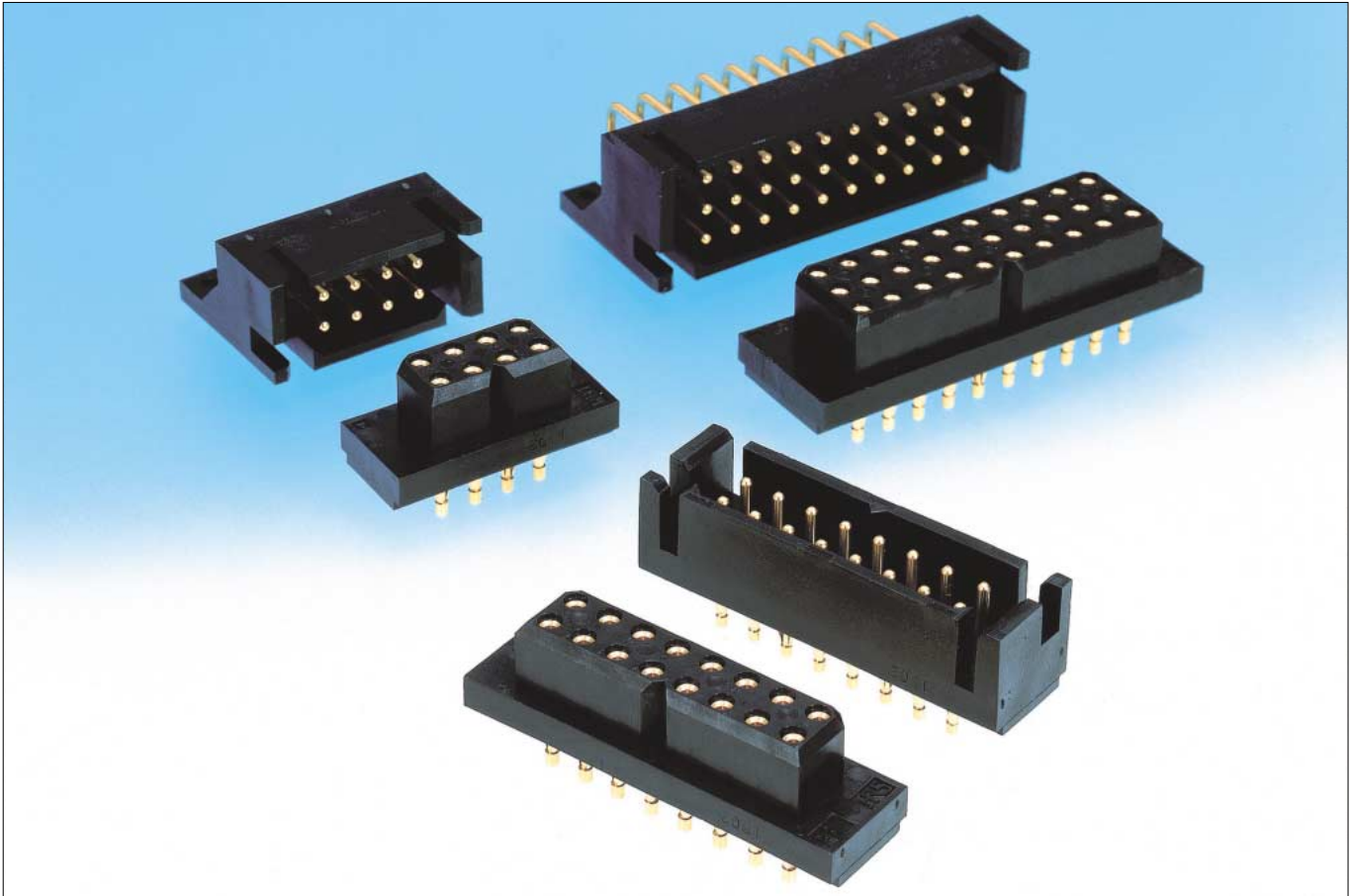

■ Features

1. High Current Applications

Board-to-board connectors are UL certified for 27 A per contact.

2. Hirose's Unique Compliant Press-fit connection to the PCB (patents pending)

The compliant section is designed to provide reliable and damage free connection with the Plated-Through-hole, reducing stresses to the PCB.

3. Multiple Contacts in a Variety of Configurations

offered with 8, 16 and 30 contacts in vertical, right angle, solder and compliant press-fit terminations.

4. UL Recognized, CSA Certified

UL File No. E52653

CSA File No. LR95109



■ Applications

Telecom, LAN and Data storage equipment, high-end servers, and a wide variety of power supply devices.

View of the Compliant Press-Fit section application

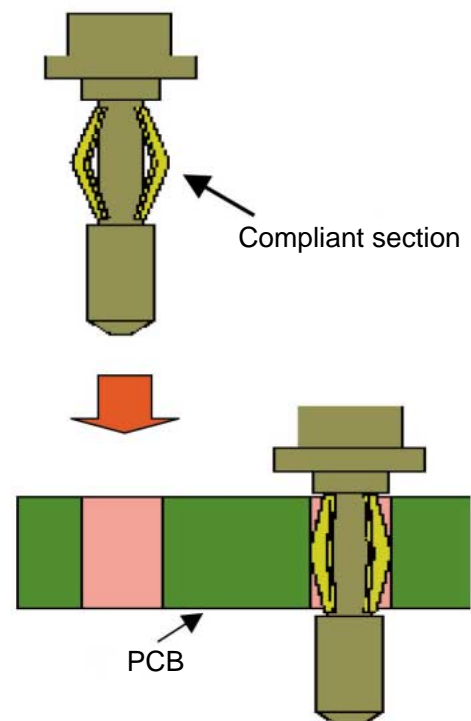

Min.PCB thickness = 3.2 mm

Product Specifications

Ratings	Current rating 27 A max. (Note 1)	Operating temperature range -55°C to +125°C (Note 2)	Storage temperature range -10°C to +60°C (Note 3)
	Voltage rating 600 V AC	Operating humidity level Relative humidity 95% max. (provided there is no condensation)	Storage humidity range 40% to +70%

Item	Specification	Conditions
1. Insulation resistance	5000M ohms min.	500 V DC
2. Withstanding voltage	No flashover or insulation breakdown.	2000V AC applied /one minute
3. Contact resistance	3m ohms max. (initial value)	25 A DC
4. Vibration	No electrical discontinuity of 1 ms or more No damage, cracks, or parts dislocation.	Frequency of 10 to 2,000 Hz, overall amplitude of 1.5 mm Or, acceleration of 196 m/s ² for 2 hours in each of 3 directions.
5. Heat resistance	Contact resistance: 7m ohms max.	Expose to a temperature of +125°C for 96 hours.
6. Cold resistance	Contact resistance: 7m ohms max.	Expose to a temperature of -55°C for 96 hours.
7. Temperature cycle	Contact resistance: 7m ohms max. Insulation resistance: 5000M ohms min. No damage, cracks, or parts dislocation.	(-55°C: 30 minutes => 15 to 30°C: 5 minutes max. => 125°C: 30 minutes => 15 to 30°C: 5 minutes max.) 20 cycles
8. Humidity resistance	Contact resistance: 7m ohms max. Insulation resistance: 5000 M ohms min.	56 days at temperature of 40°C±2°C and humidity of 90% to 95%
9. High temperature exposure	Contact resistance: 7m ohms max.	1500 hours at temperature of 85°C
10. Operating life	Contact resistance: 7m ohms max.	1000 cycles
11. Sulfur dioxide gas	Contact resistance: 7m ohms max.	Leave for 96 hours in an atmosphere of 25 ppm concentration sulfur dioxide gas.

Note1: Refer to "Current-Temperature De-rating Curve" (IEC 512-3, Test 5b) and "Temperature Rise Curve" (IEC 512-3 Test 5a) on Page 3.

Note2: The term "storage" refers to products stored for long period of time prior to mounting and use. Operating Temperature Range and Humidity range covers non- conducting condition of installed connectors in storage, shipment or during transportation.

Materials

Product	Part	Material	Finish	Remarks
Pin headers	Insulator	PBT	Black	UL94V-0
	Contacts	Copper alloy	Gold plating	-----
Receptacles	Insulator	PBT	Black	UL94V-0
	Contacts	Copper alloy	Gold plating	-----

Ordering Information

MCN 51 - 30 P 3 - DS

① ② ③ ④ ⑤

① Series name : MCN51	④ Rows 2: 2 rows 3: 3 rows
② Number of contacts : 8, 16, 30	⑤ Contact type PFA : Press-fit (through-hole diameter 2.03 mm) DS : Right-angle through-hole type
③ Connector type P : Pin header S : Socket Receptacle	

◆ Current - Temperature De-rating Curve

●(IEC 512-3, Test 5b)

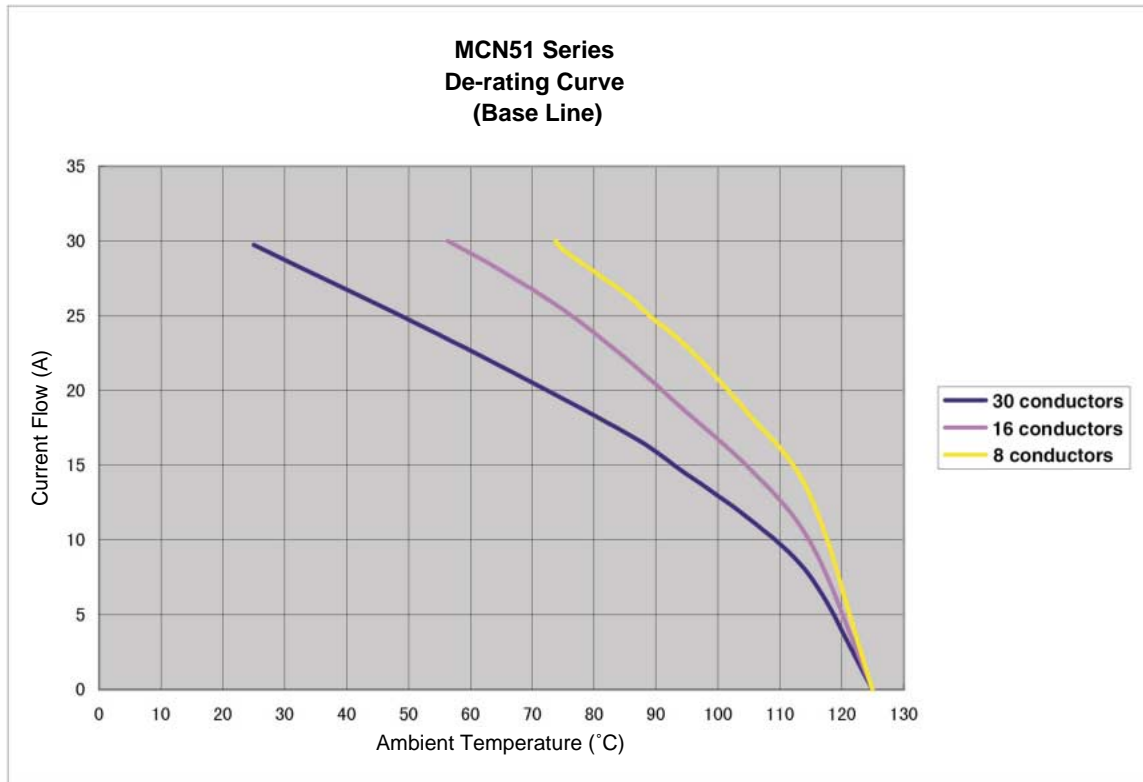

Measurements were made with 12 AWG wire connected in series to all contacts.

◆ Temperature Rise Curve

●(IEC 512-3, Test 5a)

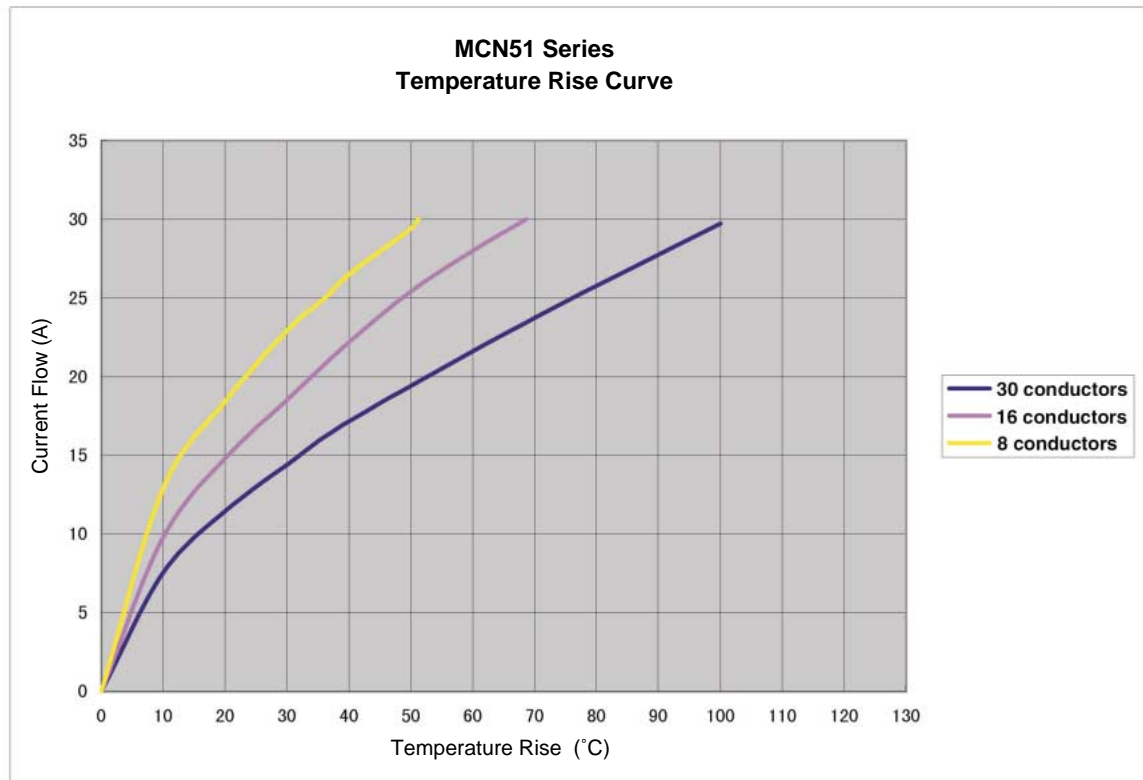

Measurements were made with 12 AWG wire connected in series to all contacts.

■Receptacle: Straight, Press-Fit

●2-row type

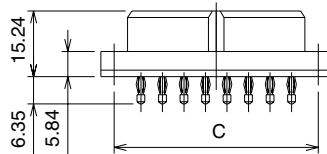
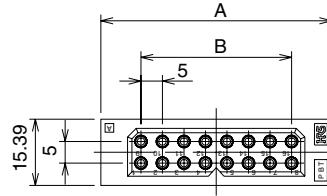
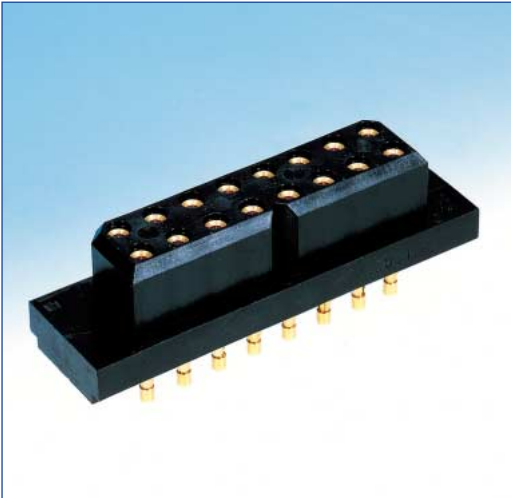

PCB mounting pattern

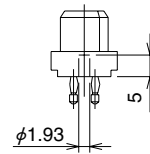
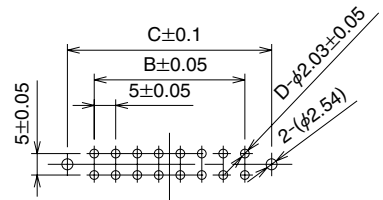

Copper plating thickness : $70 \pm 10 \mu\text{m}$
 Solder plating thickness : $5 \text{ to } 10 \mu\text{m}$
 Board thickness : 3.2 mm min.

Fasten to the board being sure to use (American type) #2 tapping screws.
 Recommended Through-Hole Diameter
 Finished hole : $2.03 \text{ dia.} \pm 0.05 \text{ mm}$
 Drill diameter : $2.185 \text{ dia.} \pm 0.025 \text{ mm}$

Part Number	CL No.	A	B	C	No.of Contacts(D)
MCN51-8S2-PFA	589-0200-6	33.63	15	27.43	8
MCN51-16S2-PFA	589-0199-9	53.64	35	47.45	16

●3-row type

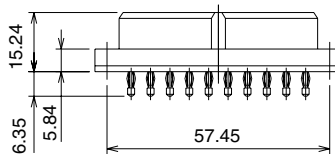
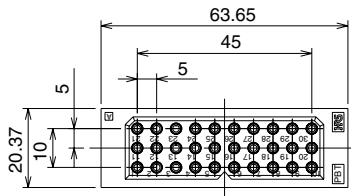
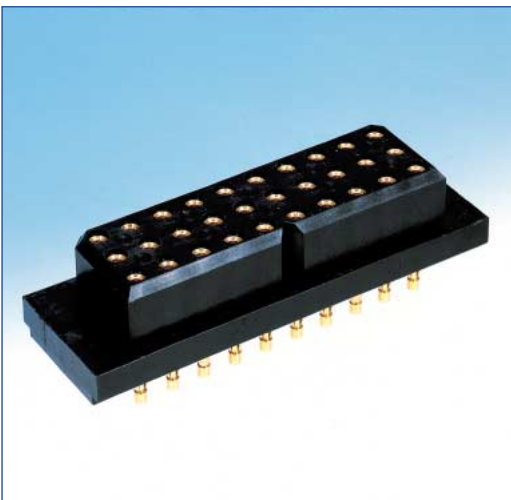

PCB mounting pattern

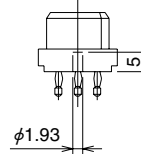
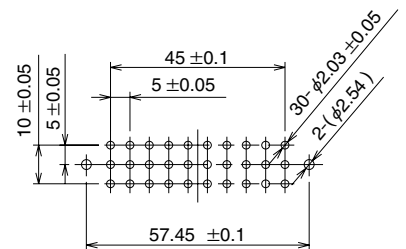

Copper plating thickness : $70 \pm 10 \mu\text{m}$
 Solder plating thickness : $5 \text{ to } 10 \mu\text{m}$
 Board thickness : 3.2 mm min.

Fasten to the board being sure to use (American type) #2 tapping screws.
 Recommended Through-Hole Diameter
 Finished hole : $2.03 \text{ dia.} \pm 0.05 \text{ mm}$
 Drill diameter : $2.185 \text{ dia.} \pm 0.025 \text{ mm}$

Part Number	CL No.	No. of Contacts
MCN51-30S3-PFA	589-0196-0	30

Pin Header: Right-Angle Through-hole

●2-row type

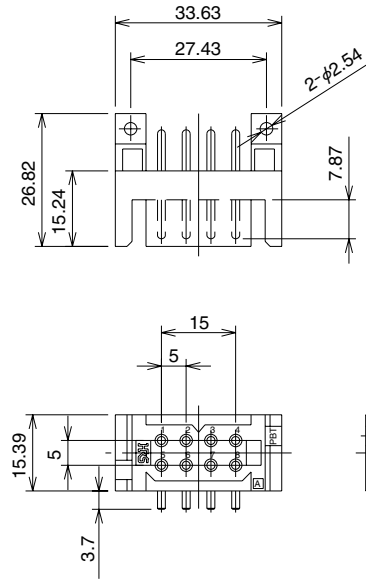
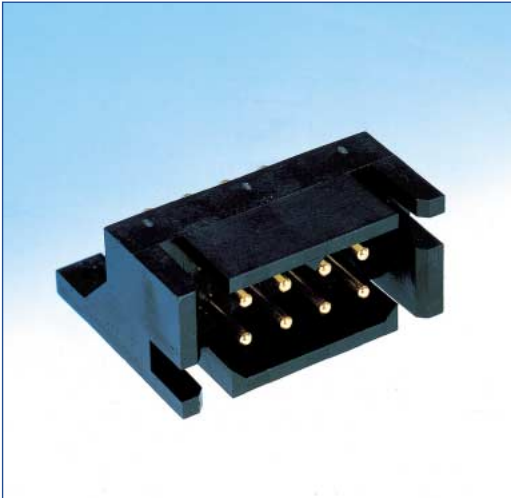

PCB mounting pattern

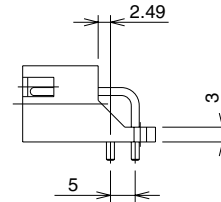
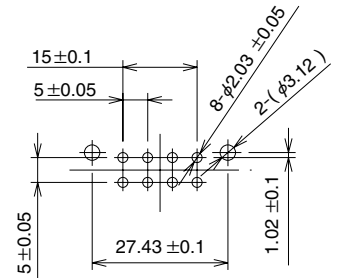

Part Number	CL No.	No. of Contacts
MCN51-8P2-DS	589-0202-1	8

●3-row type

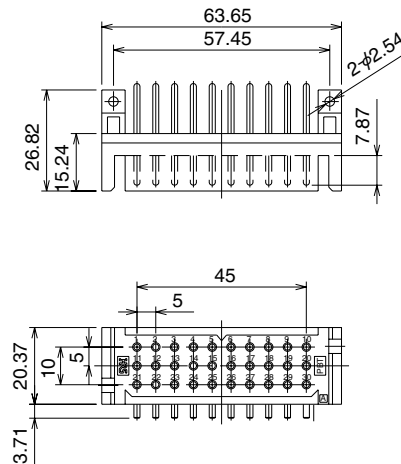

PCB mounting pattern

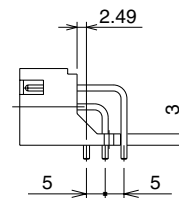
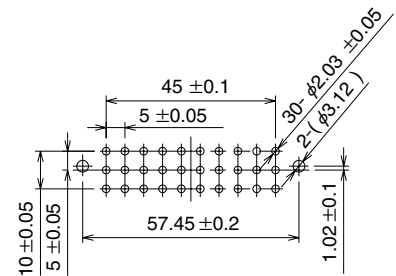

Part Number	CL No.	No. of Contacts
MCN51-30P3-DS	589-0195-8	30

■Pin Header: Straight, Press-Fit

●2-row type

PCB mounting pattern

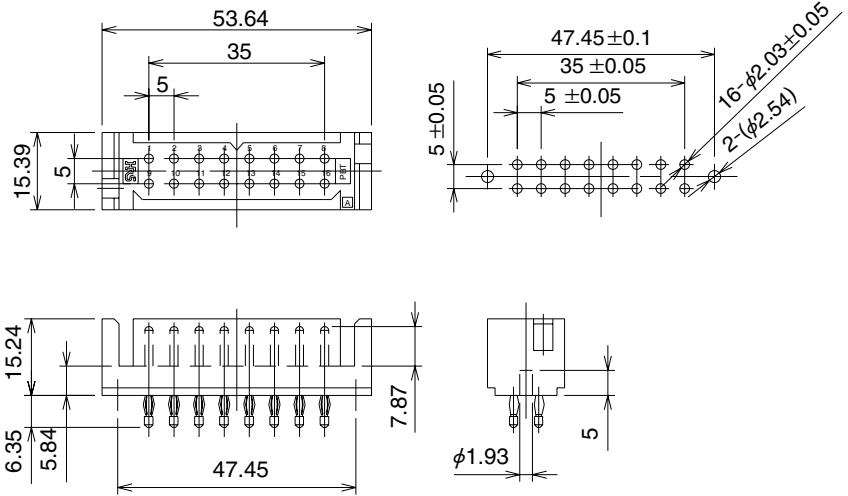
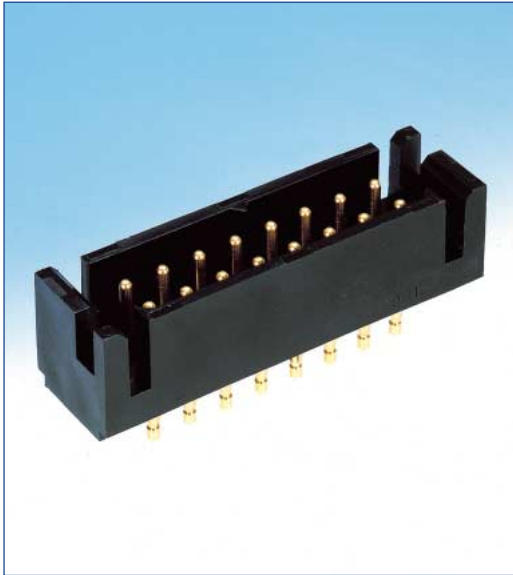

Copper plating thickness : $70 \pm 10 \mu\text{m}$
 Solder plating thickness : 5 to $10 \mu\text{m}$
 Board thickness : 3.2 mm min.

Fasten to the board being sure to use (American type) #2 tapping screws.
 Recommended Through-Hole Diameter
 Finished hole : 2.03 dia. ± 0.05 mm
 Drill diameter : 2.185 dia. ± 0.025 mm

Part Number	CL No.	No. of Contacts
MCN51-16P2-PFA	589-0201-9	16