

## 400-mA Smart Regulator for Network Interface Card

### FEATURES

- Single Fixed 3.3-V Output
- Linear Regulator for 5-V Power Input
- Auxilliary Input Can Be Bypassed
- Automatically Switches Between Linear Regulator and Bypass Mode
- Linear Regulator: 3.3-V  $\pm$ 3% Output at 400-mA Current; 600-mA Peak Output Current
- Low Bypass Switch Voltage-Drop: <55-mV at 150 mA
- Built-in Short Circuit and Thermal Shutdown Protection

- Low Supply Current
- SOIC-8 Package

### APPLICATIONS

- Network Interface Cards (NIC)
- PCMCIA Cards
- Cardbus
- Desktop Computers/Workstations

### DESCRIPTION

The Si91861 provides a constant 3.3-V output with multiple inputs. This function is required in many power interface applications, such as the Network Interface Card (NIC). The Si91861 is offered in small SOIC-8 package with up to 2-W power handling capability. The complete application circuit uses only three external components.

$5 V_{IN} > 3.3 V_{AUX}$ , where the selection is done internally and automatically by the Si91861. The power handling capability is as such as to carry at least 400-mA continuous load current for any power input condition.

The linear regulator steps down from the 5-V supply ( $5 V_{IN}$ ) to 3.3 V. A 200-m $\Omega$  bypass switch is integrated to connect the 3.3- $V_{AUX}$  input to the output. The power drawn priority is

In order to satisfy the stringent ambient temperature requirements in many applications, the Si91861 is rated for the industrial temperature range of  $-40^{\circ}\text{C}$  to  $85^{\circ}\text{C}$ .

The Si91861 is available in both standard and lead (Pb)-free packages.

### FUNCTIONAL BLOCK DIAGRAM

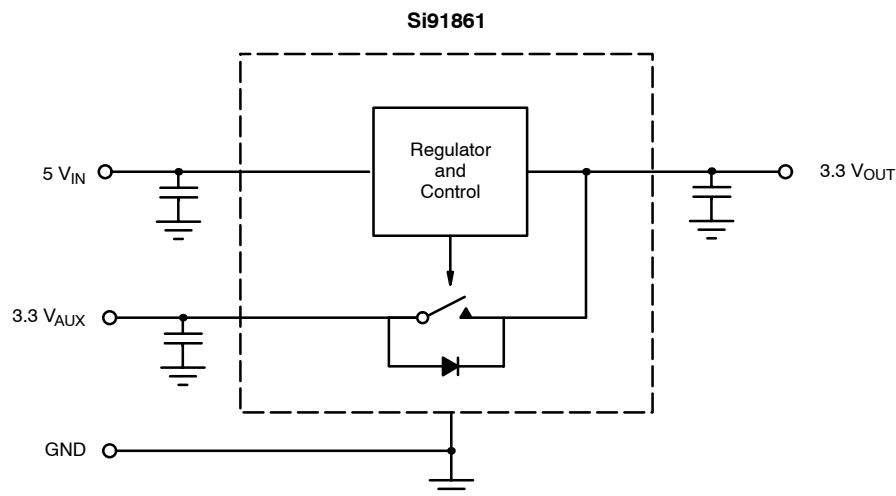

### ABSOLUTE MAXIMUM RATINGS

Pin 2, 4 Voltage	-0.3 V to 6 V
Linear Regulator Output Current	600 mA
Bypass Switch Current	600 mA
Maximum Junction Temperature, $T_{J(max)}$	150°C
Storage Temperature, $T_{STG}$	-55°C to 150°C
ESD (Human Body Model)	2 kV

Package Power Dissipation <sup>b</sup>	
$P_D$	2W (internally limited via thermal shutdown)
Thermal Impedance ( $\theta_{JA}$ ) <sup>a</sup>	62.5°C/W

## Notes

- Device mounted with all leads soldered or welded to PC board.
- Derate 16 mW/°C above  $T_A = 25^\circ\text{C}$

Stresses beyond those listed under "Absolute Maximum Ratings" may cause permanent damage to the device. These are stress ratings only, and functional operation of the device at these or any other conditions beyond those indicated in the operational sections of the specifications is not implied. Exposure to absolute maximum rating conditions for extended periods may affect device reliability.

### RECOMMENDED OPERATING RANGE

5- $V_{IN}$	4.5 V to 5.5 V	3.3 $V_{OUT}$ Loading	1 mA to 400 mA
3.3- $V_{AUX}$	3 V to 3.6 V	Operating Ambient Temperature, $T_A$	-40°C to 85°C

SPECIFICATIONS							
Parameter	Symbol	Test Conditions Unless Otherwise Specified 5 $V_{IN} = 5\text{ V}$ , 3.3 $V_{AUX} = 3.3\text{ V}$ $I_{OUT} = 1\text{ mA}$ , $C_{IN} = 4.7\text{ }\mu\text{F}$ , $C_{OUT} = 2.2\text{ }\mu\text{F}$	Temp <sup>a</sup>	Limits -40 to 85°C			Unit
				Min <sup>b</sup>	Typ <sup>c</sup>	Max <sup>b</sup>	
<b>Regulator Mode</b>							
Output Voltage (Regulator)	$V_{O(reg)}$	0 mA < $I_{OUT}$ < 400 mA, 5 $V_{IN} > 4.5\text{ V}$	Full	3.201	3.3	3.399	V
5 $V_{IN}$ Select		Rising Edge of Hysteresis	Threshold	Full		4.30	4.475
			Hysteresis	Full		230	
Ground Pin Current In Regulator Mode <sup>d</sup>	$I_{GND}$	$I_O = 0\text{ mA}$	Full		0.3	0.8	mA
		$I_O = 400\text{ mA}$	Full		0.7	1.6	
Peak Output Current (Regulator)	$I_O$	$t_{PW} = 2\text{ ms}$	Full	600			
Output Noise Voltage (Regulator)	$e_N$	BW = 50 Hz to 100 kHz, $I_{OUT} = 150\text{ mA}$	Room		300		$\mu\text{V}_{rms}$
Ripple Rejection (Regulator)	$\Delta 3.3 V_{OUT} / \Delta 5 V_{IN}$	$I_{OUT} = 150\text{ mA}$	1 kHz	Room		60	dB
			10 kHz	Room		40	
			100 kHz	Room		30	
Dynamic Line Regulation	$\Delta V_{O(line)}$	$V_{IN} = 4.5\text{ V} \cdot 5.5\text{ V}$ $t_R/t_F = 2\text{ }\mu\text{s}$ , $I_{OUT} = 150\text{ mA}$	Room		10		mV
Dynamic Load Regulation	$\Delta V_{O(load)}$	$I_{OUT}: 1\text{ mA to }150\text{ mA}$ , $t_R/t_F = 2\text{ }\mu\text{s}$	Room		20		
$V_{OUT}$ Turn-On-Time	$t_{ON}$		Room		15		$\mu\text{s}$
Thermal Shutdown Junction Temperature	$T_{J(sd)}$		Full		165		°C
Thermal Hysteresis	$T_{HYST}$		Full		20		
Short Circuit Current	$I_{SC}$	3.3 $V_{OUT} = 0\text{ V}$	Room		900		mA
<b>Bypass Mode (5 <math>V_{IN} = GND</math>)</b>							
Output Voltage	$V_{O(BP)}$	0 mA < $I_{OUT}$ < 150 mA	Full	3.247			V
Bypass Switch On-Resistance	$r_{DS(on)}$	3.0 V $\leq V_{AUX} \leq 3.6\text{ V}$	Full		0.2	0.35	$\Omega$
Ground Current <sup>d</sup>	$I_{GND}$	0 mA < $I_{OUT}$ < 400 mA	Full		200	400	$\mu\text{A}$

## Notes

- Room = 25°C, Full = -40 to 85°C.
- The algebraic convention whereby the most negative value is a minimum and the most positive a maximum.
- Typical values are for DESIGN AID ONLY, not guaranteed nor subject to production testing. Typical values at 25°C ambient.
- Ground pin current includes the IC supply current and the current to drive the linear regulator or bypass switch.

**TIMING WAVEFORMS**

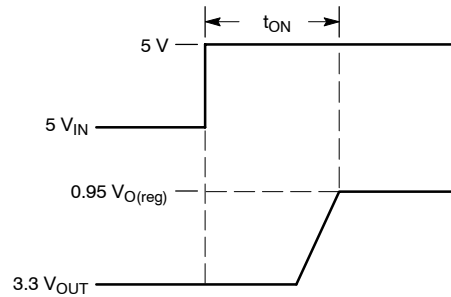

**FIGURE 1.** Timing Diagram

**PIN CONFIGURATION**

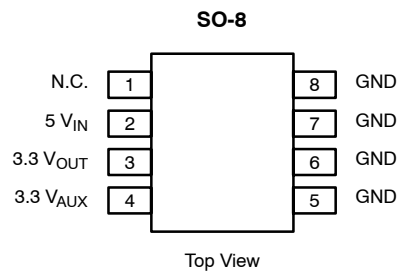

<b>PIN DESCRIPTION</b>		
<b>Pin Number</b>	<b>Name</b>	<b>Function</b>
1	N.C.	Not connected. No effect to device operation
2	$5 V_{IN}$	Power input for the Regulator
3	$3.3 V_{OUT}$	Output 3.3 V
4	$3.3 V_{AUX}$	Power input for the bypass function
5, 6, 7, 8	GND	Ground



ORDERING INFORMATION		
Part Number	Temperature Range	Package
Si91861DY-T1	-40 to 85°C	Tape and Reel
Si91861DY-T1—E3		
Si91861DY		Bulk
Eval Kit	Temperature Range	Board Type
Si91861DB	-40 to 85°C	Surface Mount

**TYPICAL CHARACTERISTICS**

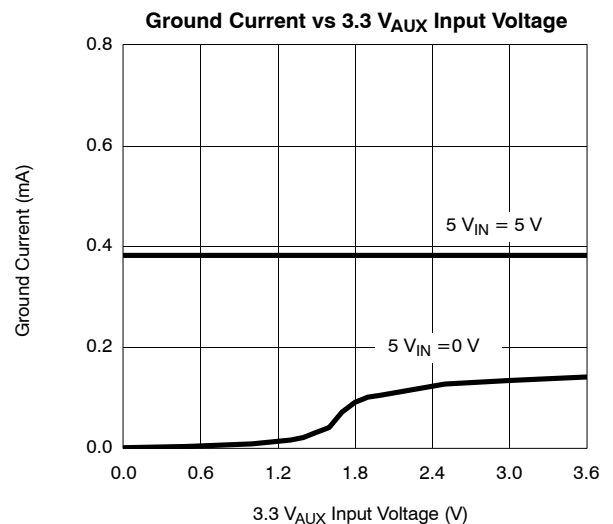
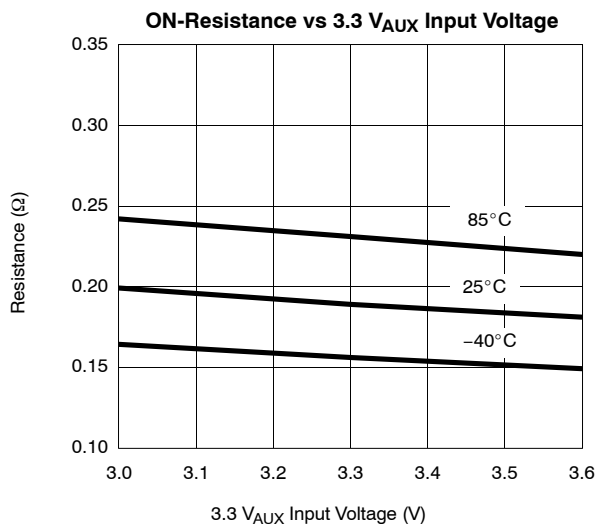
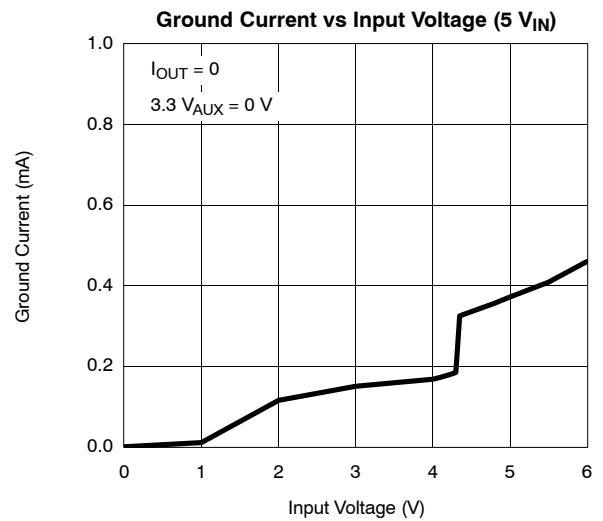
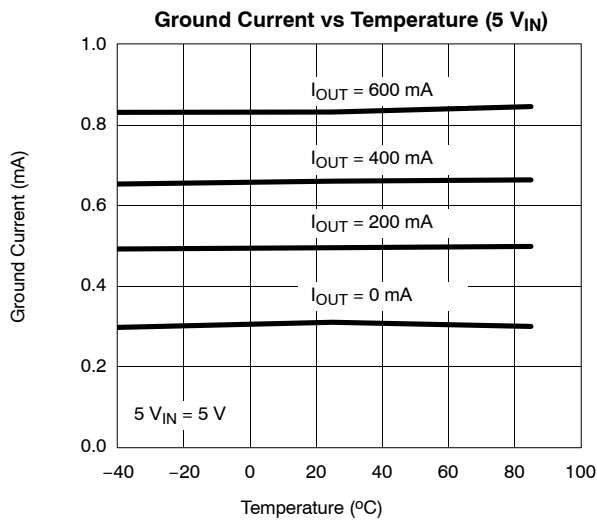

**TYPICAL WAVEFORMS**

**Load Transient Response-1**

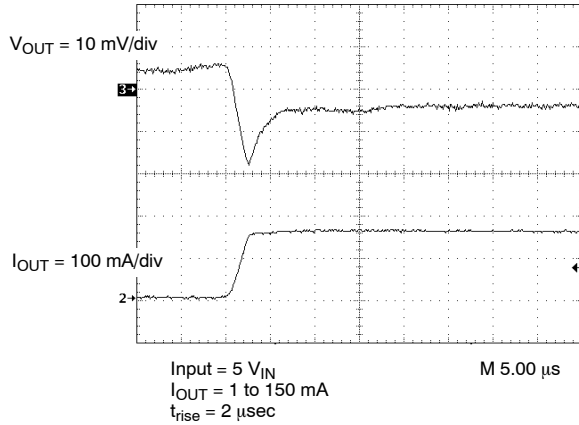

**Load Transient Response-2**

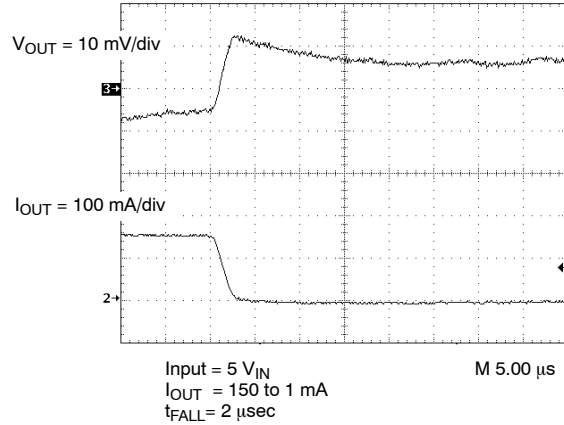

**Load Transient Response-3**

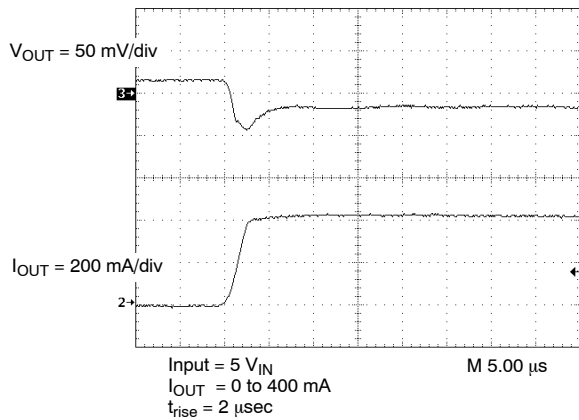

**Load Transient Response-4**

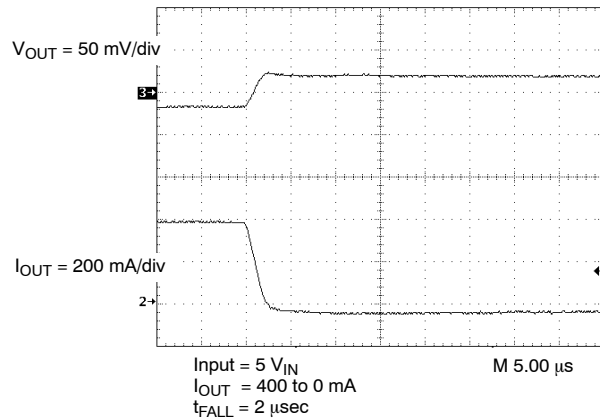

**5- $V_{IN}$  Power Up**

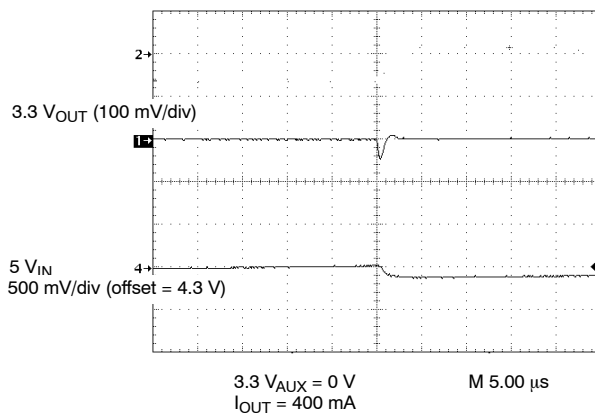

**5- $V_{IN}$  Power Down**

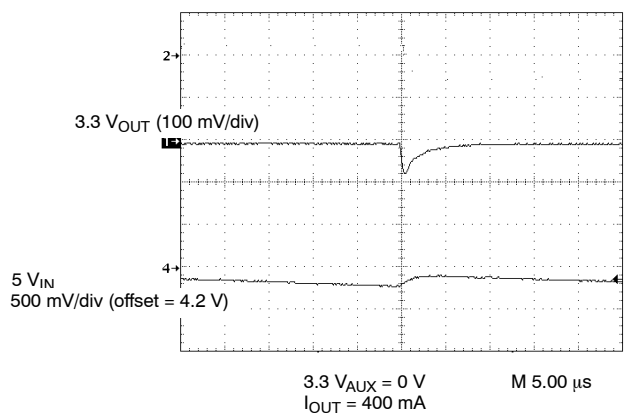



**TYPICAL WAVEFORMS**

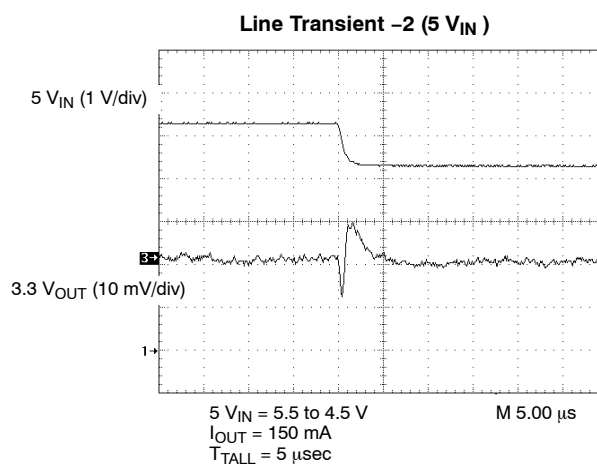
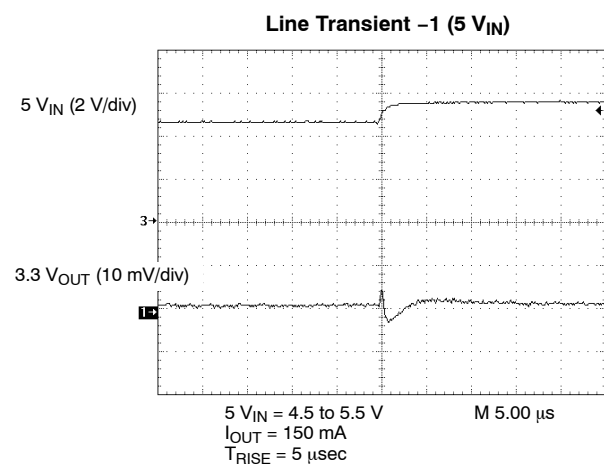
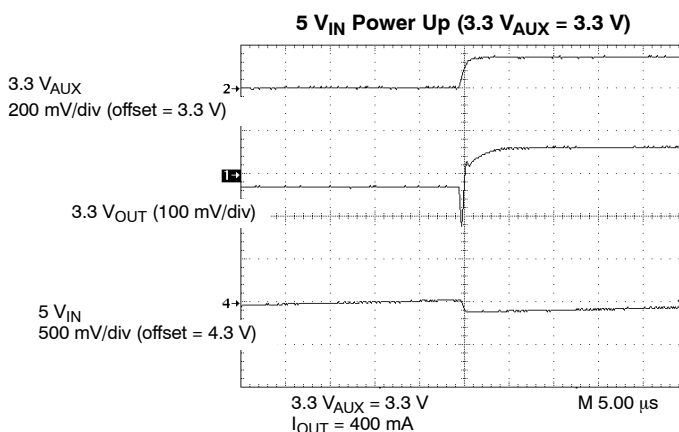
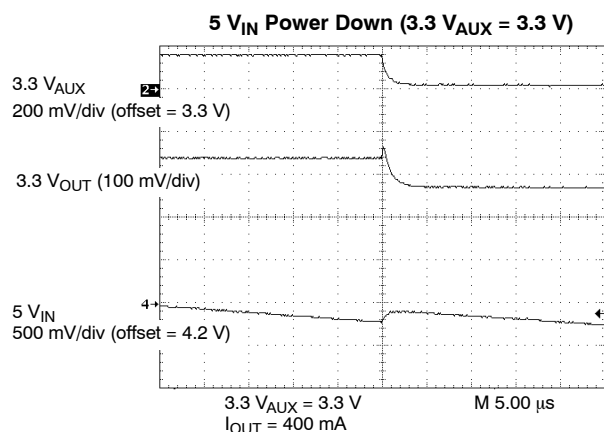

**Power Supply Ripple Rejection vs. Frequency**

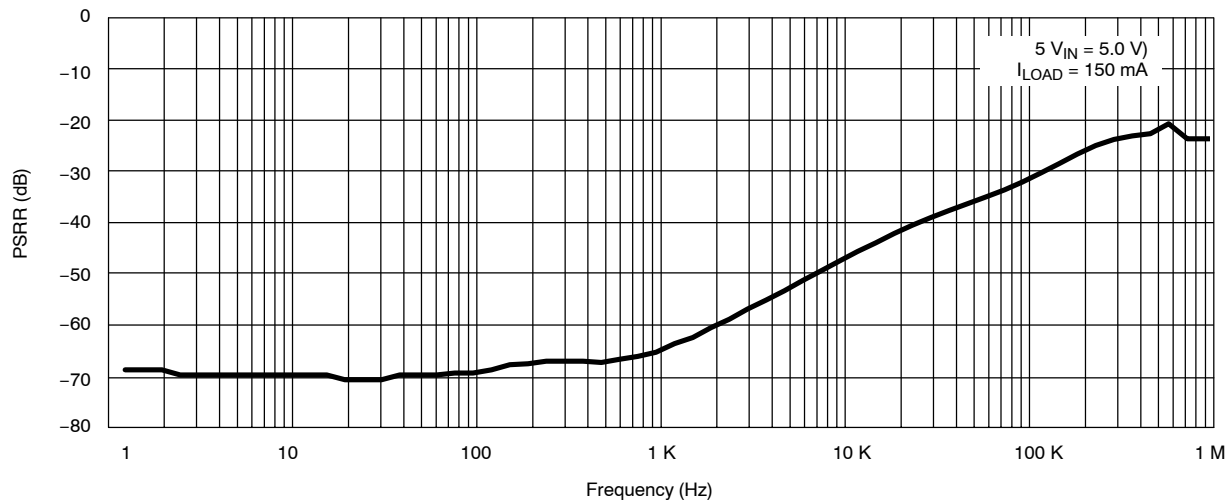

**BLOCK DIAGRAMS AND TYPICAL APPLICATION CIRCUIT**

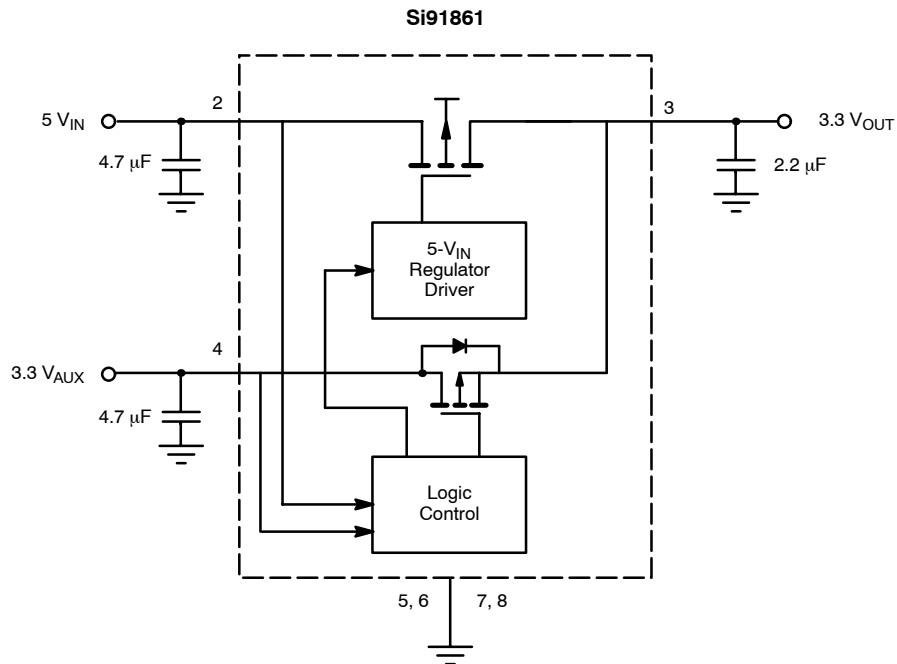

**DETAIL DESCRIPTION**

During normal operation, the 5- $V_{IN}$  input powers the fixed 3.3-V output (3.3  $V_{OUT}$ ) through an internal linear regulator. If 5  $V_{IN}$  falls below 4.07 V, the output (3.3  $V_{OUT}$ ) is powered from 3.3- $V_{AUX}$  input. The power drawn sequence is from 5  $V_{IN}$ , then 3.3  $V_{AUX}$ . The device prevents reverse current from flowing from the output to any unbiased or low voltage input.

**Linear Regulator Mode**

The output is regulated at 3.3 V when the 5- $V_{IN}$  pin is more than 4.30 V. The linear regulator will regulate the output until the 5- $V_{IN}$  pin fall below 4.07 V.

**Bypass Mode**

When the 5- $V_{IN}$  pin falls below 4.07 V, the output is powered by 3.3  $V_{AUX}$  through a 0.2- $\Omega$  internal switch.

**Thermal and Over-current Protection**

Thermal protection limits total power dissipation in the device. It safeguards the device in the event of fault conditions. When the junction temperature exceeds 165°C, the device turns off. The device turns back on once its junction temperature cools down by approximately 20°C. The device has overcurrent protection (typically at 900 mA) when it operates in linear regulator mode. A continuous short at output pin (3.3  $V_{OUT}$ ) will result in a pulsed output as the thermal protection circuitry cycles the device on and off. For continuous operation, do not exceed the junction rating of 150°C. In bypass mode, the device is not current limited.