

ESD132-B1-W0201

Bi-directional TVS device, 5.5 V, 0.45 pF, 0201

- Order now
- Technical documents
- Simulation
- Support

Product description

This Infineon transient voltage suppressor (TVS) device has a bi-directional and symmetric I/V characteristic for optimized design and assembly.

Feature list

- ESD / transient protection according to:
 - IEC61000-4-2 (ESD): ± 30 kV (air) / ± 30 kV (contact)
 - IEC61000-4-4 (EFT): ± 4 kV / ± 80 A (5/50 ns)
 - IEC61000-4-5 (Surge): ± 9 A (8/20 μ s)
- Bi-directional maximum working voltage: $V_{WM} = \pm 5.5$ V
- Line capacitance: $C_L = 0.45$ pF at $f = 1$ MHz
- Clamping voltage: $V_{cl} = 7$ V at $I_{TLP} = 16$ A with $R_{dyn} = 0.2 \Omega$
- Very low leakage current: $I_L = 100$ nA (max.)
- Small form factor SMD size 0201, low profile (0.58 x 0.28 x 0.15 mm³) [\[2\]](#)



Potential applications

- USB 3.0 / 3.1 / 3.2 Gen 1
- DVI, HDMI, Display Port
- Ethernet

Product validation

Qualified for industrial applications according to the relevant tests of JEDEC47/20/22.

Device information

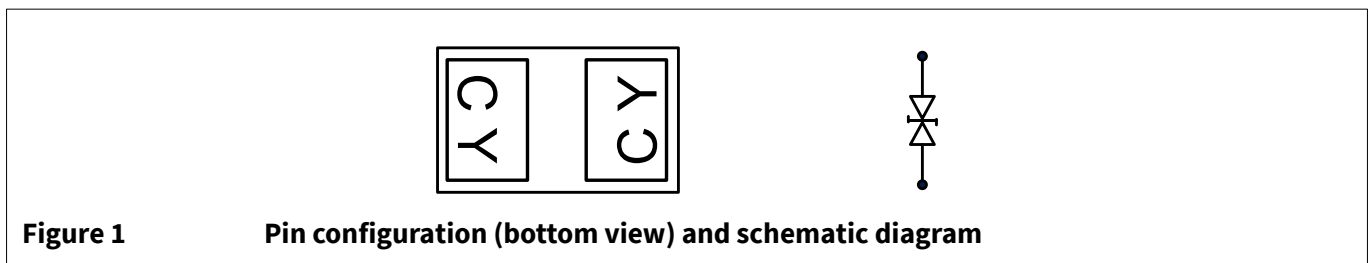

Figure 1 Pin configuration (bottom view) and schematic diagram

Table 1 Part information

Product name / Ordering code	Package	Pin configuration	Marking	Pieces / Reel
ESD132-B1-W0201 / ESD132B1W0201E6327XTSA1	WLL-2-3	1 line, bi-directional	CY	15 k

Table of contents

	Product description	1
	Feature list	1
	Potential applications	1
	Product validation	1
	Device information	1
	Table of contents	2
1	Absolute maximum ratings	3
2	Electrical characteristics	4
3	Typical characteristic diagrams	6
4	Package information WLL-2-3	13
5	References	14
	Revision history	14
	Disclaimer	15

Absolute maximum ratings

1 Absolute maximum ratings

Table 2 Absolute maximum ratings at $T_A = 25\text{ °C}$, unless otherwise specified

Parameter	Symbol	Values		Unit	Note or test condition
		Min.	Max.		
Maximum working voltage	V_{WM}	-5.5	+5.5	V	
ESD discharge	V_{ESD} (contact)	-30	+30	kV	Discharge network: $R = 330\ \Omega$, $C = 150\ \text{pF}$ ¹⁾
	V_{ESD} (air)	-30	+30		
Peak pulse power	P_{PK}	–	63	W	Stress pulse: 8/20 μs current waveform ²⁾
Peak pulse current	I_{PP}	-9	+9	A	Stress pulse: 8/20 μs current waveform ²⁾
Operating temperature range	T_{op}	-55	+125	°C	
Storage temperature	T_{stg}	-65	+150		

Attention: *Stresses above the maximum values listed here may cause permanent damage to the device. Exposure to absolute maximum rating conditions for extended periods may affect device reliability. Exceeding only one of these values may cause irreversible damage to the component.*

¹ Based on IEC61000-4-2.

² Based on IEC61000-4-5.

Electrical characteristics

2 Electrical characteristics

Note: $T_A = 25\text{ }^\circ\text{C}$, unless otherwise specified. Device is electrically symmetrical.

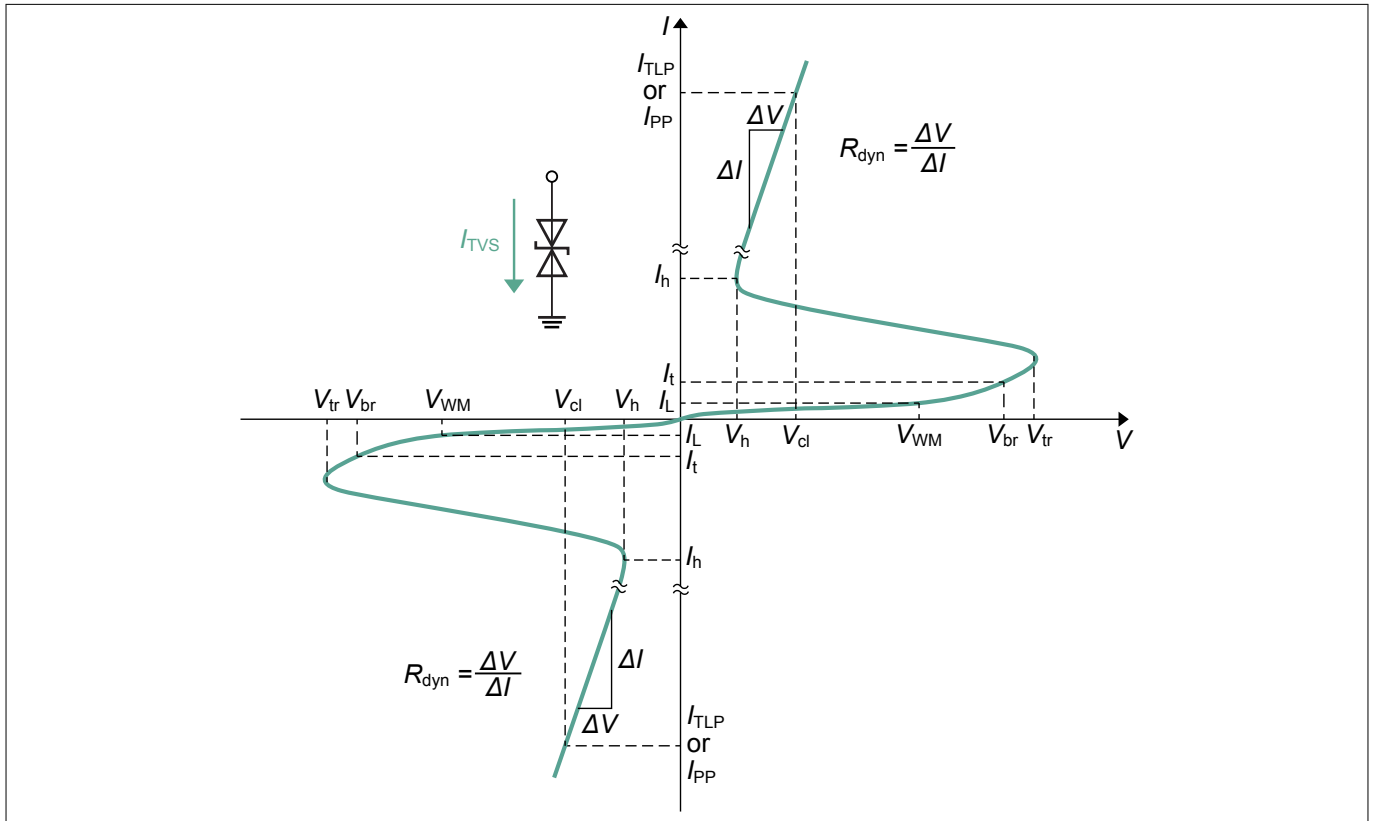

Figure 2 Definitions of electrical characteristics

Table 3 Electrical parameters

Symbol	Parameter
R_{dyn}	Dynamic resistance
V_{WM}	Maximum working voltage
V_{cl}	Clamping voltage
V_{TLP}	TLP voltage
I_{TLP}	TLP current
V_t	Test voltage
I_t	Test current
V_h	Holding voltage
I_h	Holding current
V_{br}	Breakdown voltage
V_{tr}	Trigger voltage
I_L	Leakage current
V_{ESD}	Maximum electrostatic discharge voltage, based on IEC61000-4-2
I_{PP}	Peak pulse current, based on IEC61000-4-5

Electrical characteristics

Table 4 DC characteristics

Parameter	Symbol	Values			Unit	Note or test condition
		Min.	Typ.	Max.		
Breakdown voltage	V_{br}	6.1	8.5	–	V	$I_t = 1 \text{ mA}$
Holding voltage	V_h	–	1.8	–		$I = I_h$
Holding current	I_h	–	30	–	mA	$V = V_h$
Leakage current	I_L	–	–	100	nA	$V_{WM} = \pm 5.5 \text{ V}$

Table 5 AC characteristics

Parameter	Symbol	Values			Unit	Note or test condition
		Min.	Typ.	Max.		
Line capacitance	C_L	–	0.45	0.55	pF	$V_t = 0 \text{ V}, f = 1 \text{ MHz}$

Table 6 ESD and surge characteristics

Parameter	Symbol	Values			Unit	Note or test condition
		Min.	Typ.	Max.		
Clamping voltage (TLP) ³⁾	V_{cl}	–	5.5	–	V	$I_{TLP} = 8 \text{ A}$
		–	7	–		$I_{TLP} = 16 \text{ A}$
		–	9.5	–		$I_{TLP} = 30 \text{ A}$
Clamping voltage (8/20) ⁴⁾		–	3	–		$I_{PP} = 1 \text{ A}$
		–	6	8		$I_{PP} = 8 \text{ A}$
Dynamic resistance ³⁾	R_{dyn}	–	0.2	–	Ω	

³⁾ TLP parameters: $Z_0 = 50 \Omega$, $t_p = 100 \text{ ns}$, $t_r = 0.6 \text{ ns}$. Refer to application note AN210 [1].

⁴⁾ $t_p = 8/20 \mu\text{s}$. Stress pulse based on IEC61000-4-5.

Typical characteristic diagrams

3 Typical characteristic diagrams

Note: $T_A = 25\text{ }^\circ\text{C}$, unless otherwise specified.

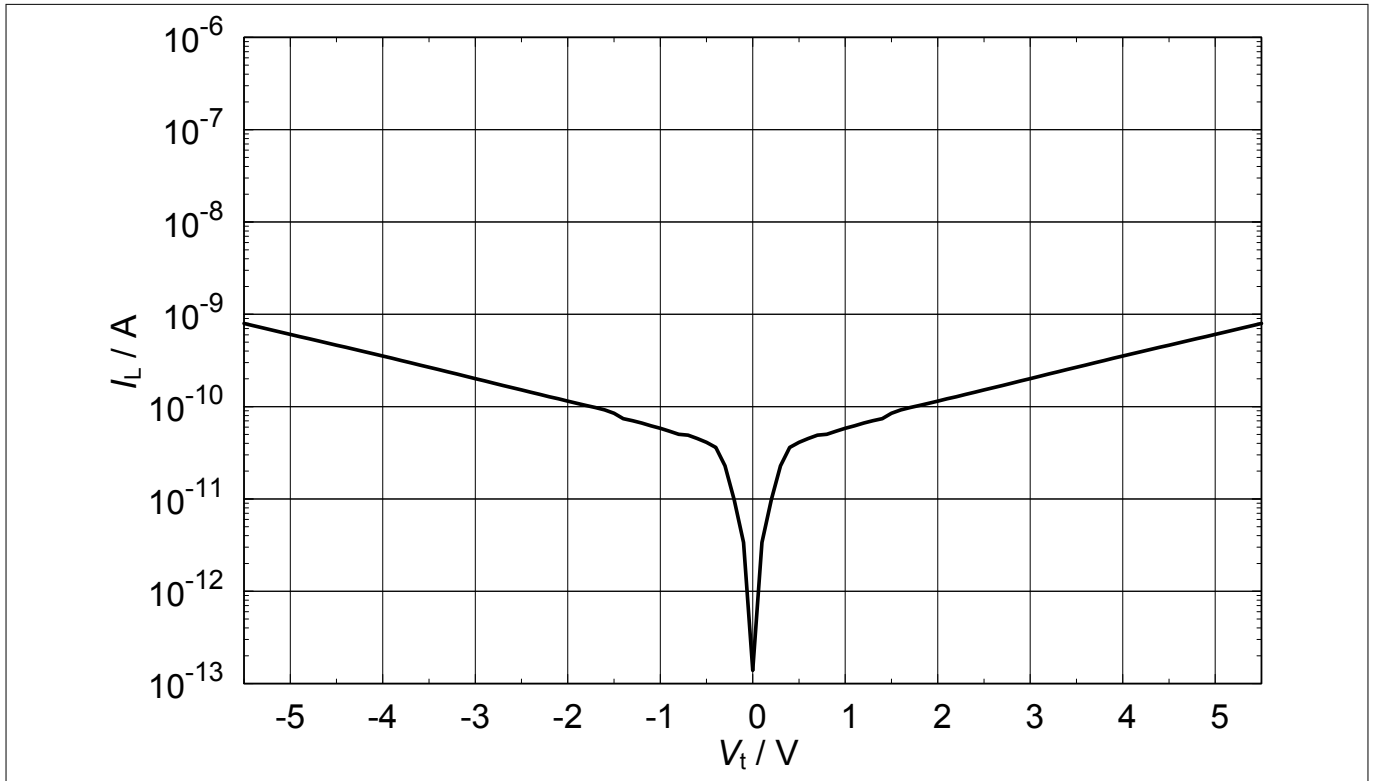

Figure 3 Leakage current: $I_L = f(V_t)$

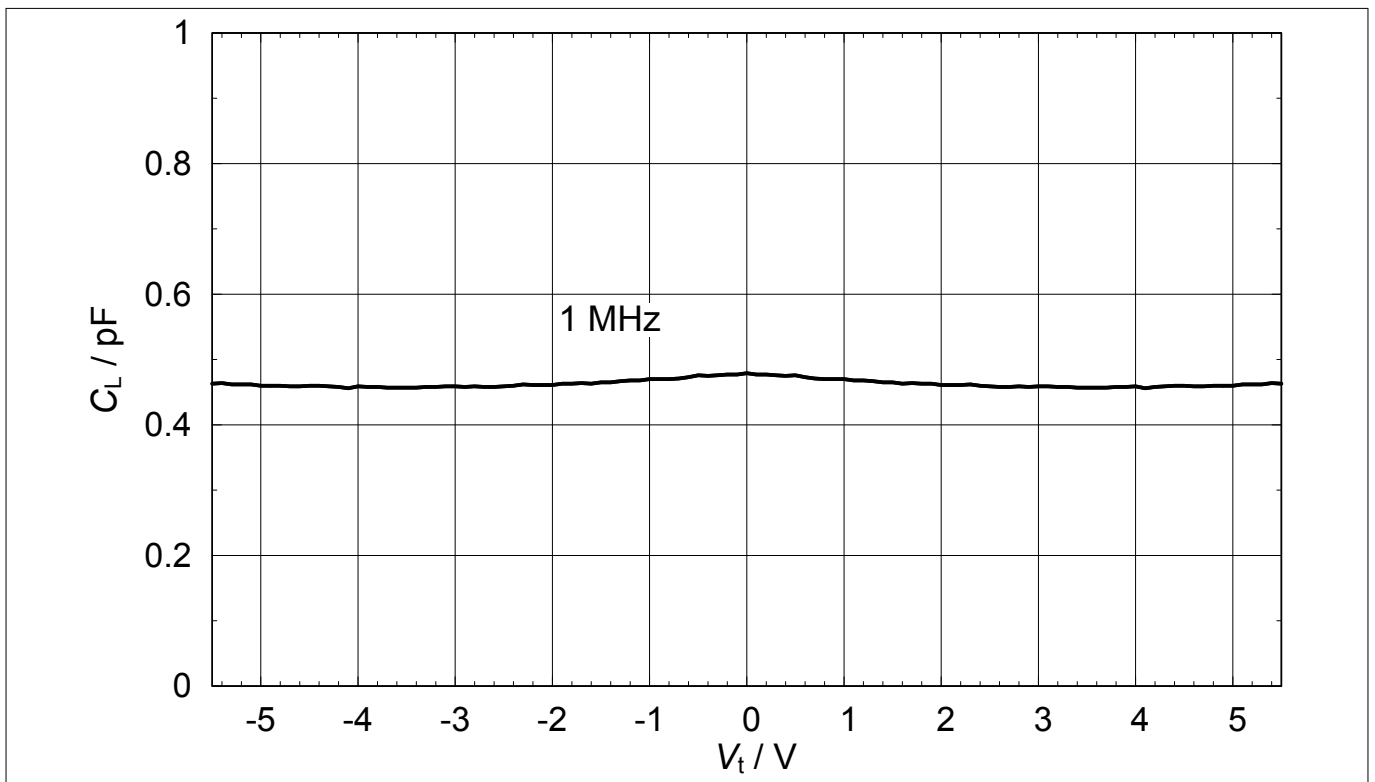

Figure 4 Line capacitance: $C_L = f(V_t)$, $f = 1\text{ MHz}$

Typical characteristic diagrams

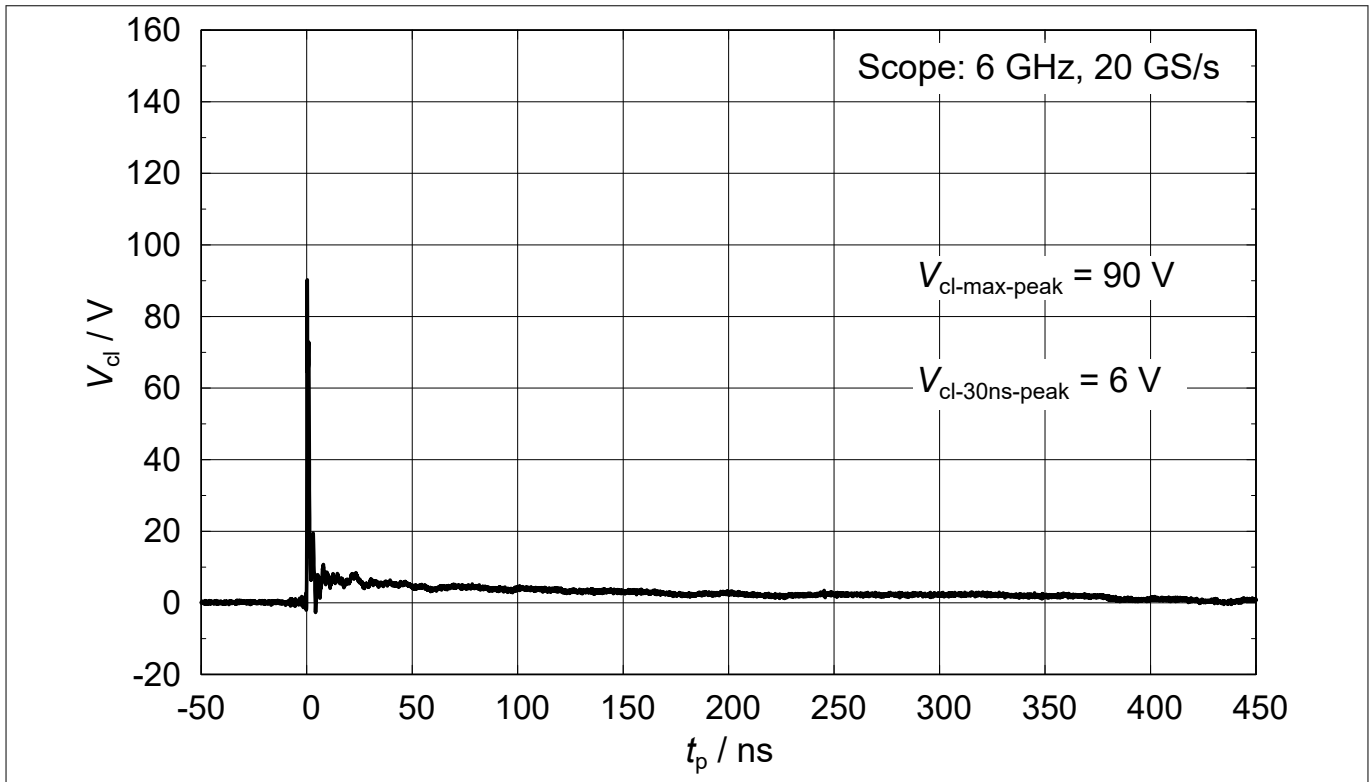

Figure 5 Clamping voltage (ESD): $V_{cl} = f(t_p)$, 8 kV positive pulse based on IEC61000-4-2

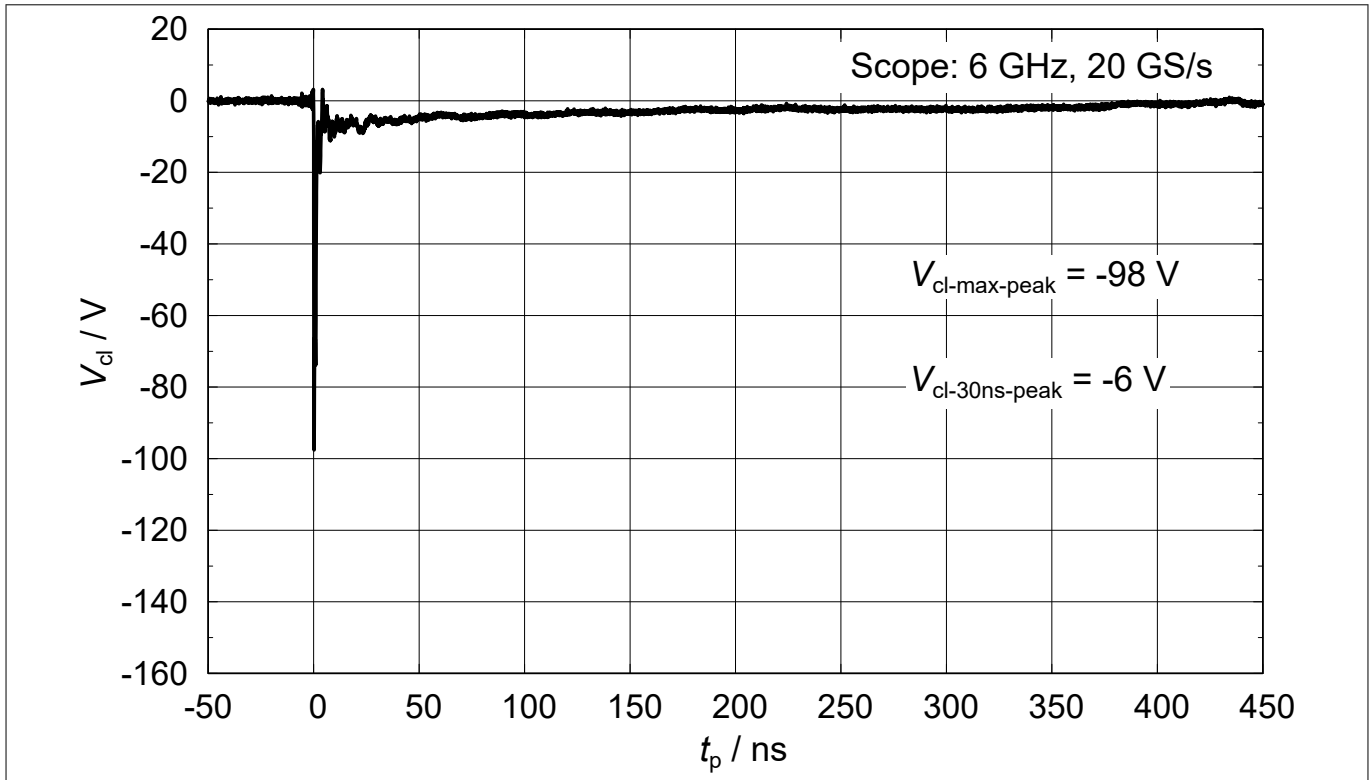

Figure 6 Clamping voltage (ESD): $V_{cl} = f(t_p)$, 8 kV negative pulse based on IEC61000-4-2

Typical characteristic diagrams

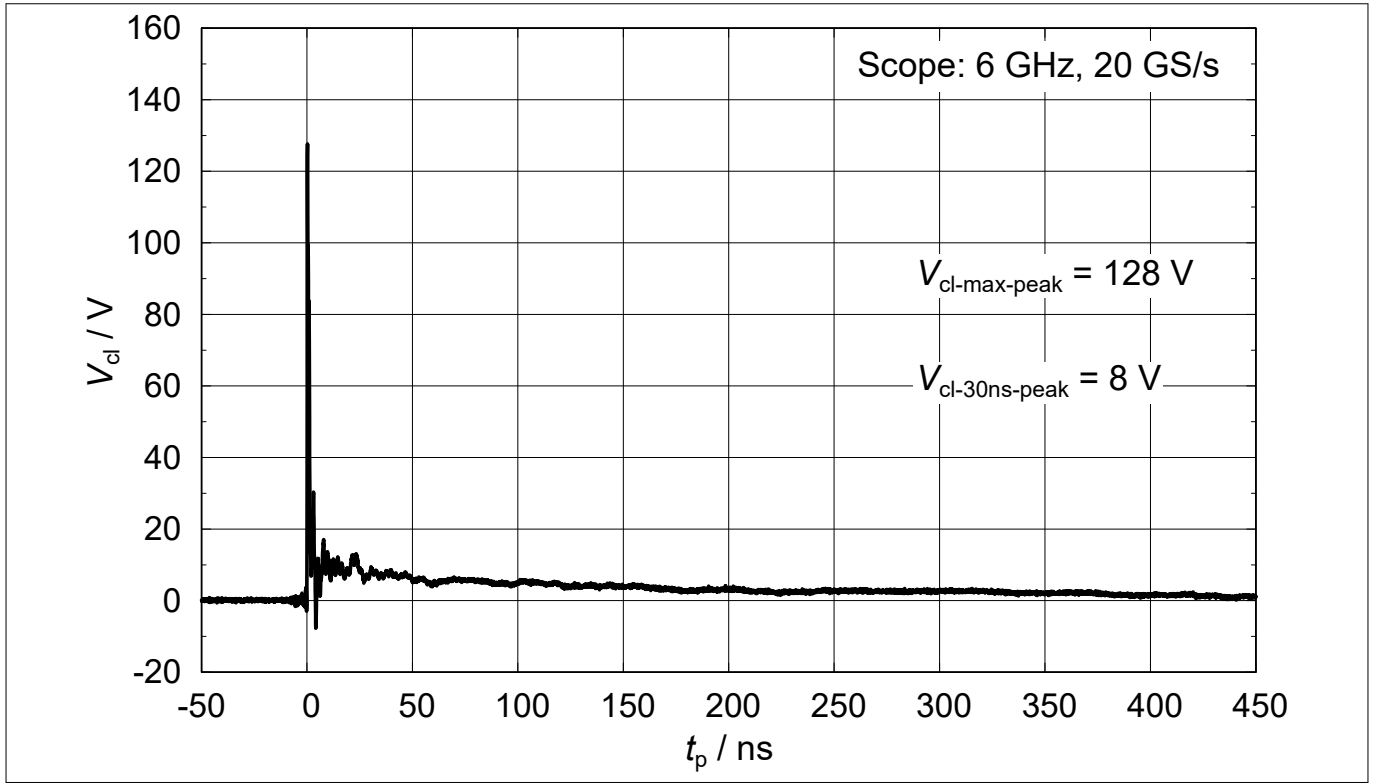

Figure 7 Clamping voltage (ESD): $V_{cl} = f(t_p)$, 15 kV positive pulse based on IEC61000-4-2

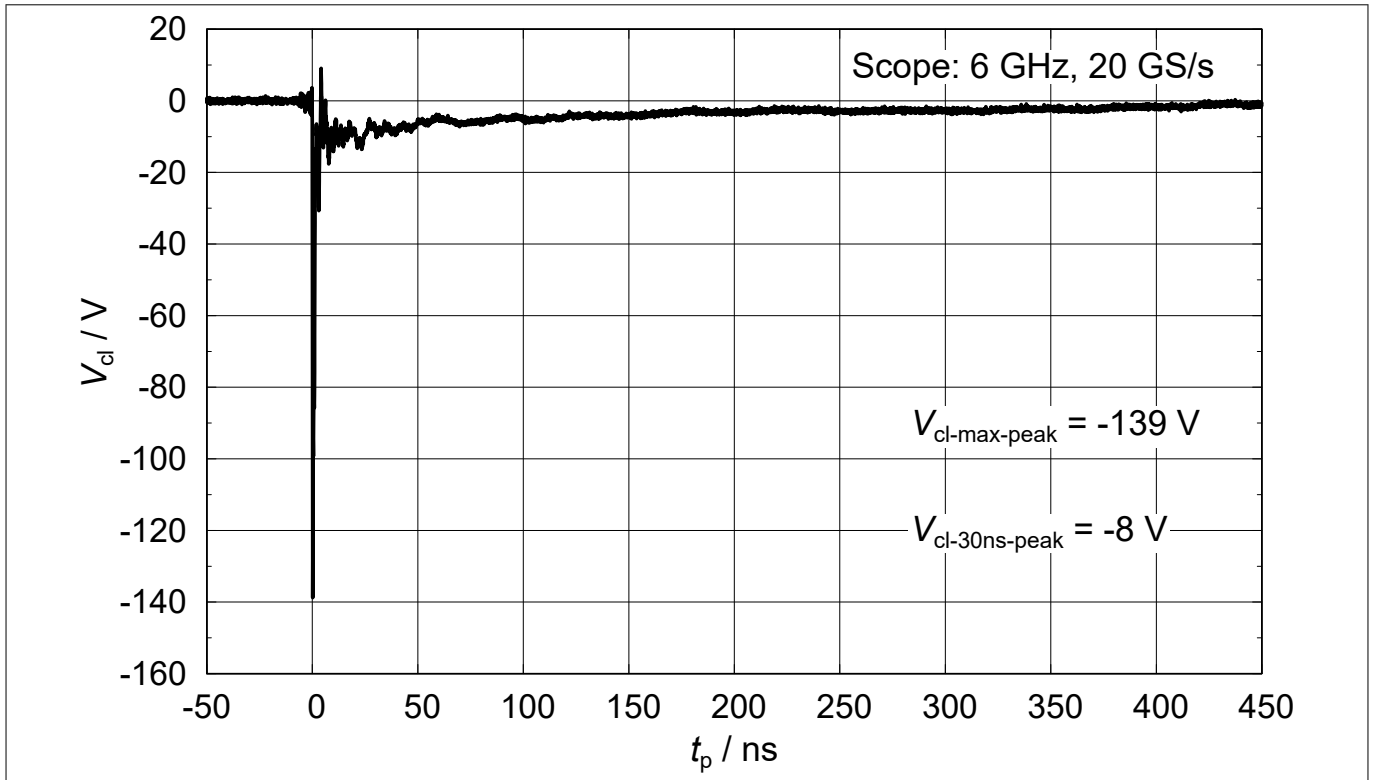

Figure 8 Clamping voltage (ESD): $V_{cl} = f(t_p)$, 15 kV negative pulse based on IEC61000-4-2

Typical characteristic diagrams

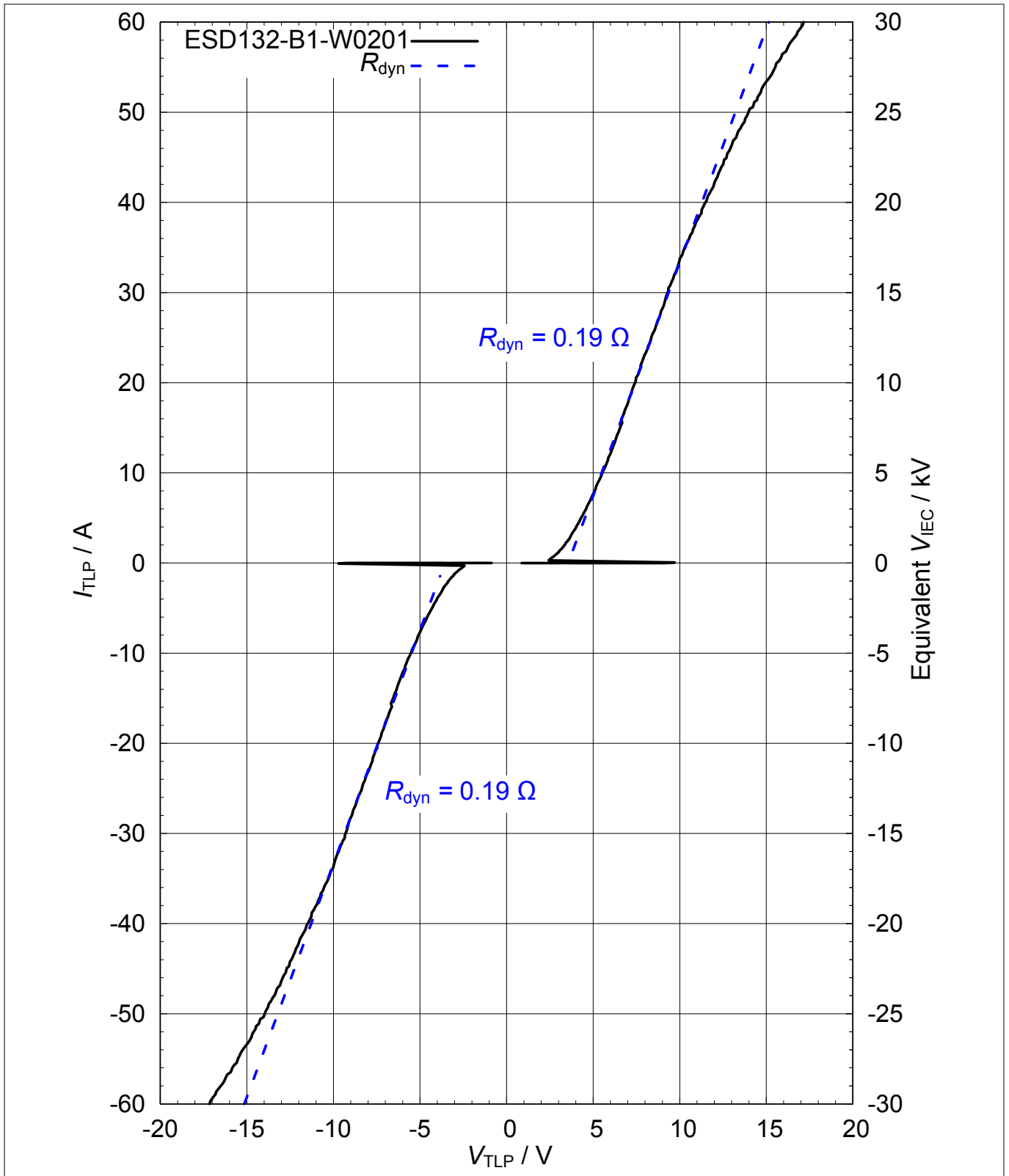

Figure 9 Clamping voltage (TLP): $I_{TLP} = f(V_{TLP})$

Typical characteristic diagrams

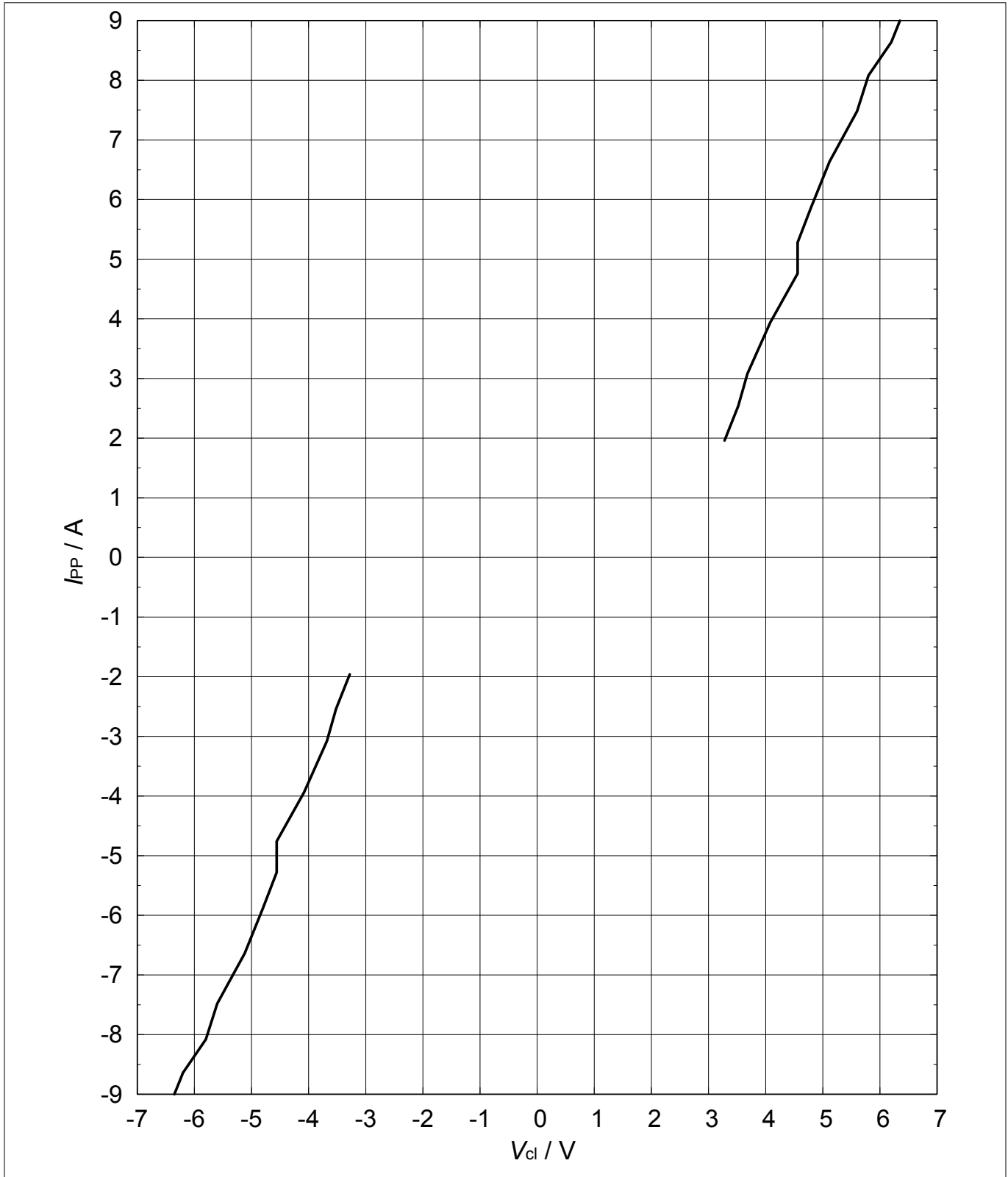

Figure 10 Clamping voltage (Surge): $I_{PP} = f(V_{Cl})$, based on IEC61000-4-5

Typical characteristic diagrams

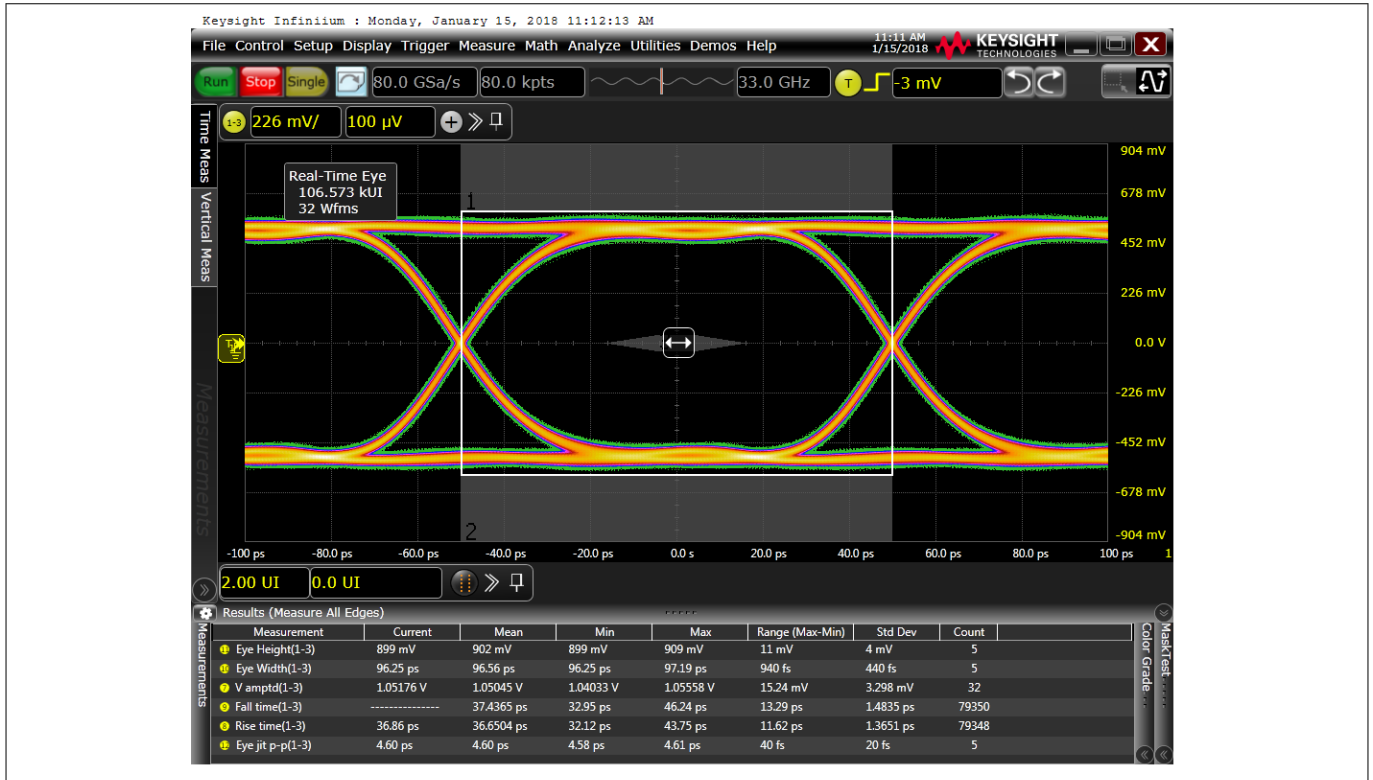

Figure 11 10 Gbps Eye diagram with USB 3.1/3.2 Gen 2 Mask, test board only

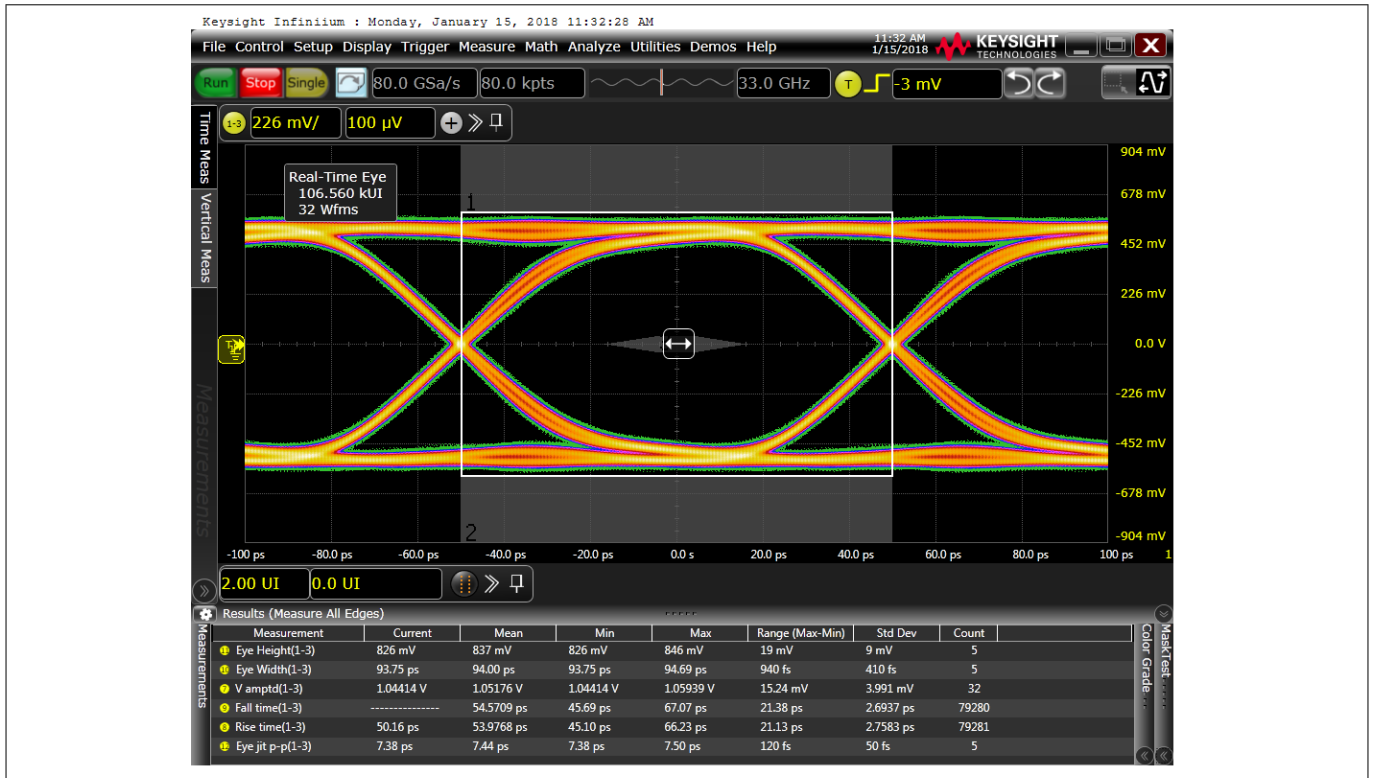

Figure 12 10 Gbps Eye diagram with USB 3.1/3.2 Gen 2 Mask, test board + ESD132-B1-W0201

Typical characteristic diagrams

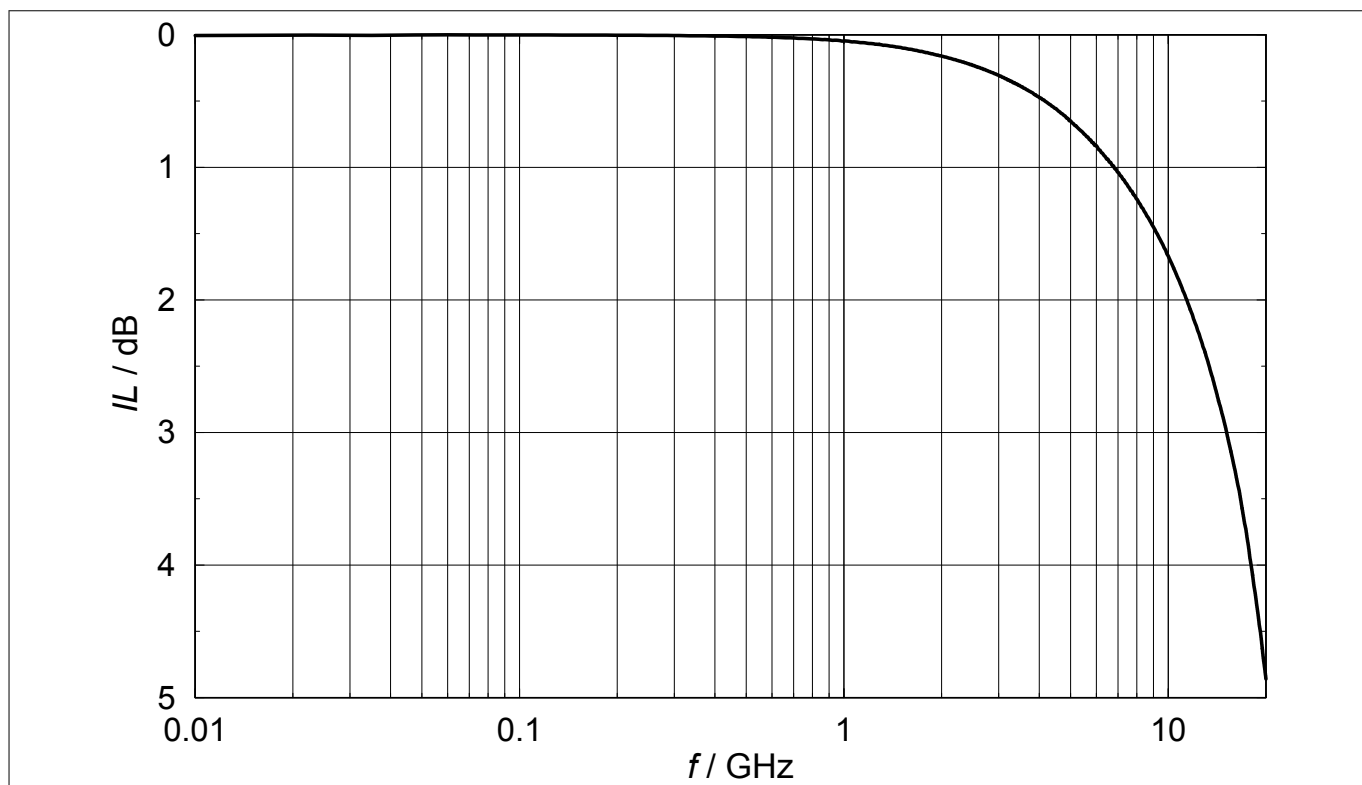

Figure 13 Insertion loss: $IL = f(f)$, measured in a 50 Ω system

Package information WLL-2-3

4 Package information WLL-2-3

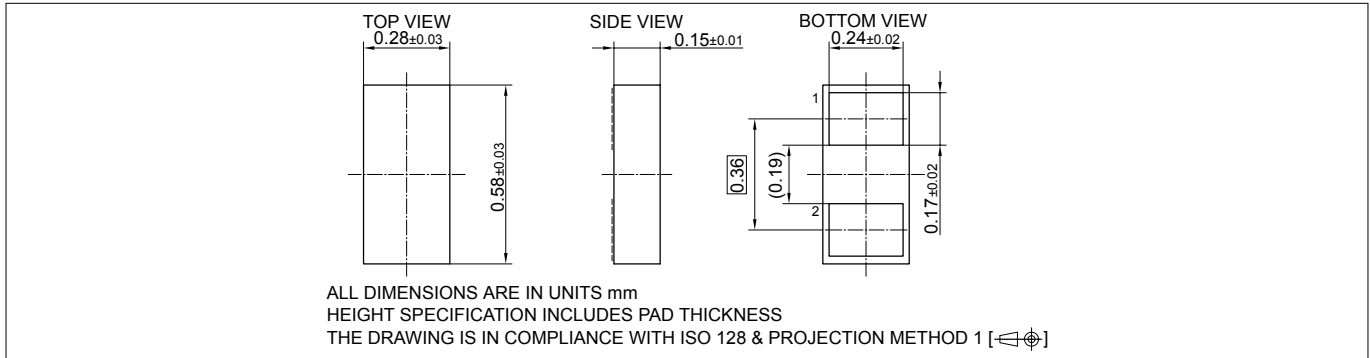

Figure 14 Package outline

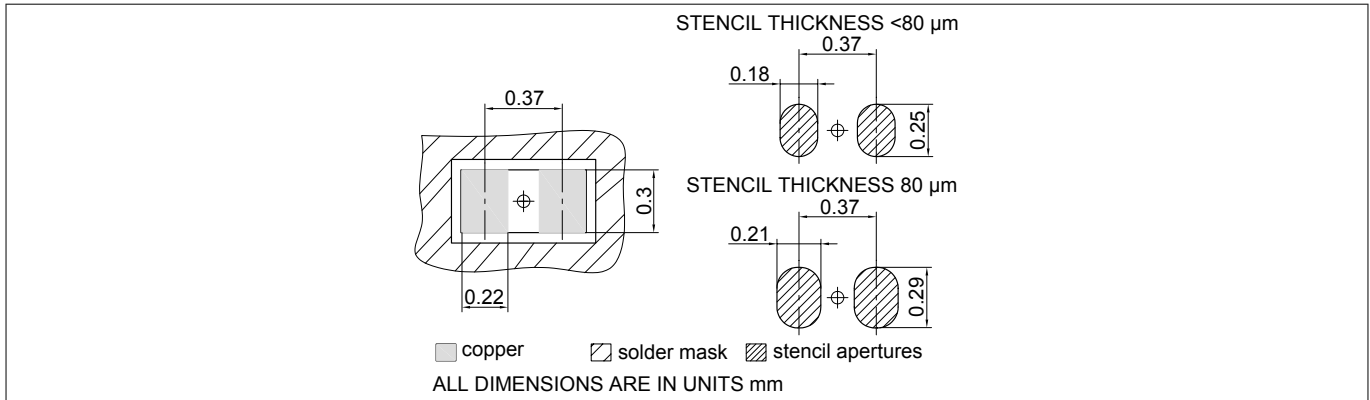

Figure 15 Footprint

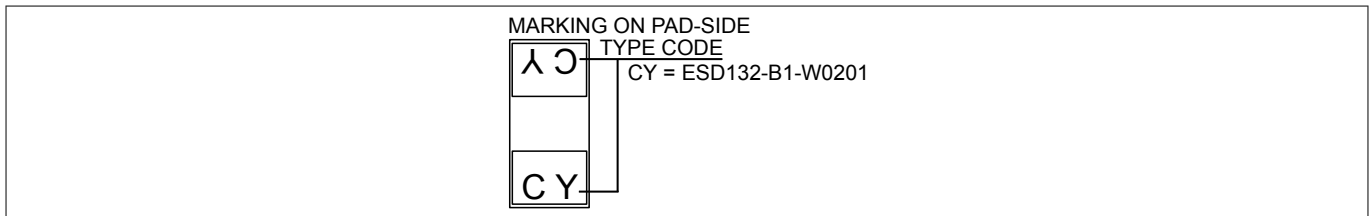

Figure 16 ESD132 Marking layout

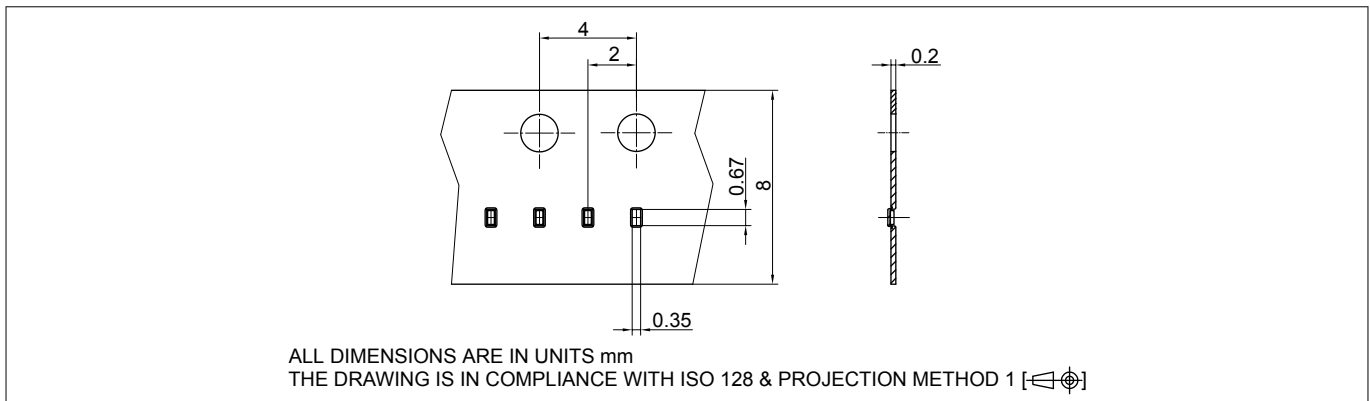

Figure 17 Packaging

References

5 References

[1]	Infineon AG - Application note AN210 : Effective ESD Protection Design at System Level Using VF-TLP Characterization Methodology
[2]	Infineon AG - Recommendations for Printed Circuit Board Assembly of Infineon WLL Packages http://www.infineon.com/Packageinformation_WLL

Revision history

Document version	Date of release	Description of changes
0.9	2018-02-06	<ul style="list-style-type: none">• First release
1.0	2018-06-26	<ul style="list-style-type: none">• Typical and maximum values updated to production values• Typical curves updated to production values• V_{cl} pulse curves and eye diagrams added• Minor editorial changes
2.0	2019-08-09	<ul style="list-style-type: none">• New datasheet layout

Trademarks

All referenced product or service names and trademarks are the property of their respective owners.

Edition 2019-08-09

**Published by
Infineon Technologies AG
81726 Munich, Germany**

**© 2019 Infineon Technologies AG
All Rights Reserved.**

**Do you have a question about any
aspect of this document?
Email: erratum@infineon.com**

**Document reference
IFX-wiz1558682416030**

IMPORTANT NOTICE

The information given in this document shall in no event be regarded as a guarantee of conditions or characteristics ("Beschaffheitsgarantie").

With respect to any examples, hints or any typical values stated herein and/or any information regarding the application of the product, Infineon Technologies hereby disclaims any and all warranties and liabilities of any kind, including without limitation warranties of non-infringement of intellectual property rights of any third party.

In addition, any information given in this document is subject to customer's compliance with its obligations stated in this document and any applicable legal requirements, norms and standards concerning customer's products and any use of the product of Infineon Technologies in customer's applications.

The data contained in this document is exclusively intended for technically trained staff. It is the responsibility of customer's technical departments to evaluate the suitability of the product for the intended application and the completeness of the product information given in this document with respect to such application.

WARNINGS

Due to technical requirements products may contain dangerous substances. For information on the types in question please contact your nearest Infineon Technologies office.

Except as otherwise explicitly approved by Infineon Technologies in a written document signed by authorized representatives of Infineon Technologies, Infineon Technologies' products may not be used in any applications where a failure of the product or any consequences of the use thereof can reasonably be expected to result in personal injury