



SPX1584

8A Low Dropout Voltage Regulator Adjustable & Fixed 3.3V

FEATURES

- Adjustable Output Down to 1.2V or Fixed 3.3V
- Output Current of 8A
- Low Dropout Voltage
- Extremely Tight Load and Line Regulation
- Current & Thermal Limiting
- Standard 3-Terminal Low Cost TO-220
- Similar to Industry Standard LT1083/LT1584

APPLICATIONS

- Powering Intel Pentium™ μ P from +5V Supplies
- Power PC™ Supplies
- SMPS Post-Regulator
- High Efficiency “Green” Computer Systems
- High Efficiency Linear Power Supplies
- Portable Instrumentation
- Constant Current Regulators
- Adjustable Power Supplies
- Battery Charger

PRODUCT DESCRIPTION

The SPX1584 is a low power 8A Adjustable Voltage Regulator that is very easy to use. It requires only 2 external resistors to set the output voltage. This device is an excellent choice when using Powering Intel™ Microprocessor to convert from +5V to 3.3V supplies, and as a post regulator for switching supplies applications. The SPX1584 features low dropout of a maximum 1.5 volts.

The SPX1584 offers full protection against over-current faults, reversed input polarity, reversed load insertion, over temperature operation, and positive and negative transient voltage. On-Chip trimming adjusts the reference voltage to 1%. The I_Q of this device flows into the load, which increases efficiency.

The SPX1584 is offered in a 3-pin TO-220 package compatible with older 3-terminal regulators. For a 5A low dropout regulator refer to the SPX1585 datasheet.

PIN CONNECTIONS

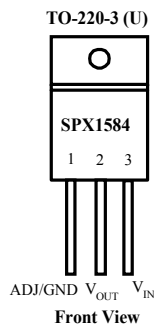

ABSOLUTE MAXIMUM RATINGS

Power Dissipation.....Internally Limited
 Lead Temp. (Soldering, 10 Seconds) 300°C
 Storage Temperature Range -65° to +150°C
 Operating Junction Temperature Range
 SPX1584 Control Section.....0C° to +125°C
 SPX1584 Power Transistor.....0C° to +150°C

Input Supply Voltage +10V
 Input to Output Voltage Differential 8.8V

ELECTRICAL CHARACTERISTICS (Note 1) at I_{OUT} = 10mA, T_A = 25°C, unless otherwise specified.

Parameter	Conditions	SPX1584A			SPX1584		Units
		Typ	Min	Max	Min	Max	
3.3V Version							
Output Voltage (Note 2)	SPX1584-3.3V, 0 ≤ I _{OUT} ≤ 1.5A, 4.75V ≤ V _{IN} ≤ 7V	3.3 3.3	3.270 3.240	3.330 3.360	3.230 3.201	3.370 3.399	V
All Voltage Options							
Reference Voltage	10mA ≤ I _{OUT} ≤ I _{FULLLOAD} 3.3V ≤ (V _{IN} - V _{OUT}) ≤ V _{IN MAX} - V _{OUT MAX}	1.250 1.250	1.238 1.225	1.262 1.270	1.238 1.225	1.262 1.270	V
Mid Load Current	(V _{IN} - V _{OUT}) = V _{IN MAX} - V _{OUT MAX}	5		10		10	mA
Line Regulation	1.5V ≤ V _{IN} - V _{OUT} ≤ V _{IN MAX} - V _{OUT MAX} I _{LOAD} = 10mA	0.015 0.05		0.2 0.5		0.2 0.5	%
Load Regulation	10mA ≤ I _{OUT} ≤ I _{FULLLOAD} (V _{IN} - V _{OUT}) = 3V	0.1 0.2		0.3 0.4		0.3 0.4	%
Dropout Voltage	I _{OUT} = I _{FULLLOAD} , ΔV _{REF} = 1%	1.1		1.2		1.2	V
Current Limit	V _{IN} - V _{OUT} = 5V	9.5	8.0		8.0		A
Long Term Stability	T _A = 125°C, 1000Hrs.	0.3		1		1	%
Adjust Pin Current	T _A = 25°C	55		90		90	μA
Adjust Pin Current Change		0.2		5		5	μA
Thermal Regulation	30ms pulse	0.003		0.01		0.01	%/W
Temperature Stability		0.5					%
Ripple Rejection Ratio	V _{IN} - V _{OUT} = 3V I _{OUT} = 3A, C _{OUT} = 25μF, C _{ADJ} = 25μF, f = 120Hz	75	60		60		dB
Output Noise, RMS	10Hz to 10kHz	0.003					% V _O
Thermal Resistance Junction-to-Case	TO-220			2.7		2.7	°C/W
	Junction to Tab			0.65		0.65	
	Junction to Ambient						

The Bold specifications apply to the full operating temperature range.

Note 1: Changes in output voltage due to heating effects are covered under the specification for thermal regulation.

Note 2: A 10μF output capacitor is required on SPX1584

TYPICAL CHARACTERISTICS

LOAD REGULATION

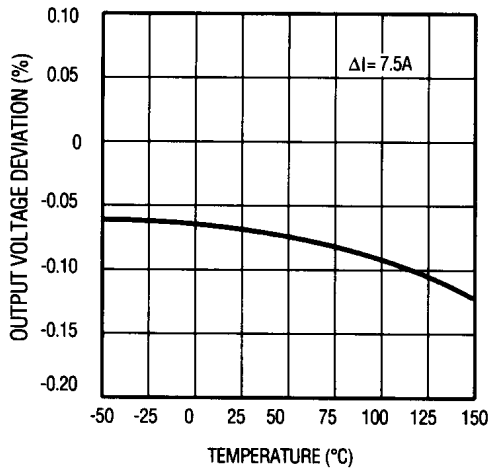

SHORT CIRCUIT CURRENT

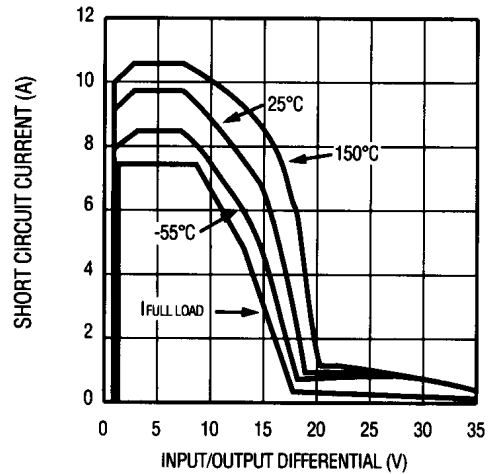

ADJUSTMENT PIN CURRENT

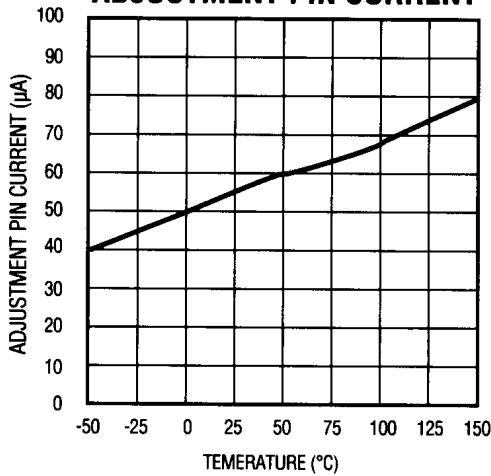

DROPOUT VOLTAGE

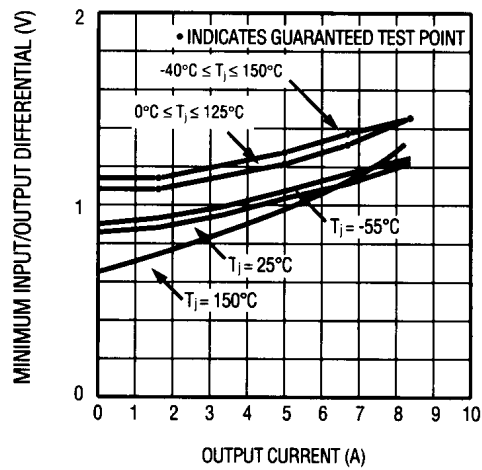

TEMPERATURE STABILITY

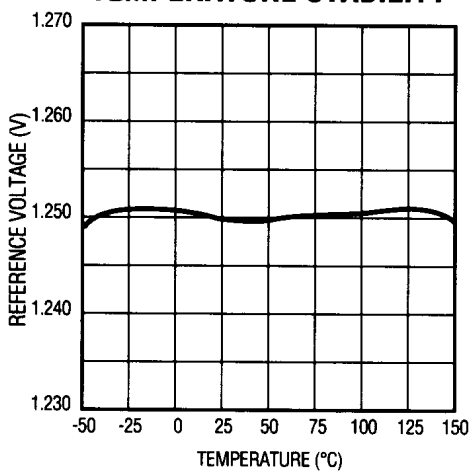

MINIMUM OPERATING CURRENT

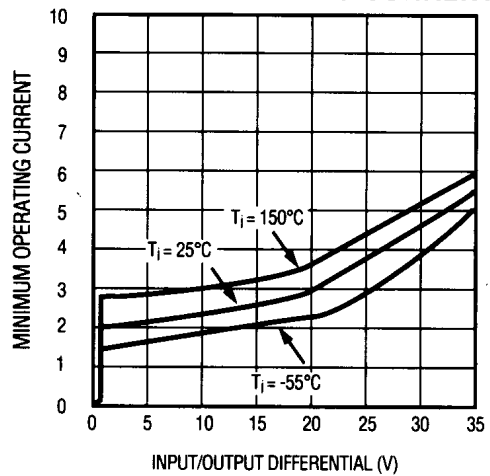

TYPICAL APPLICATIONS

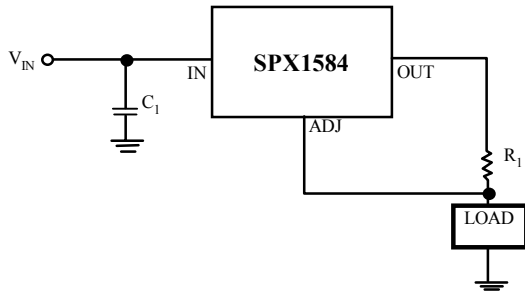

8A Current Output Regulator

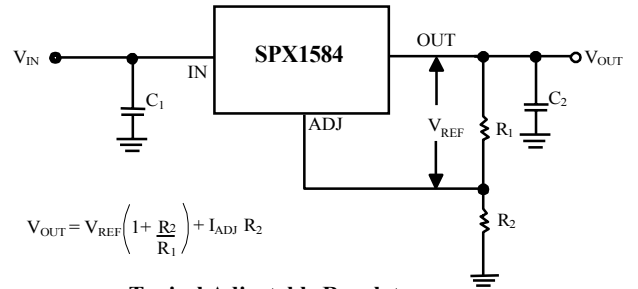

$$V_{OUT} = V_{REF} \left(1 + \frac{R_2}{R_1} \right) + I_{ADJ} R_2$$

Typical Adjustable Regulator

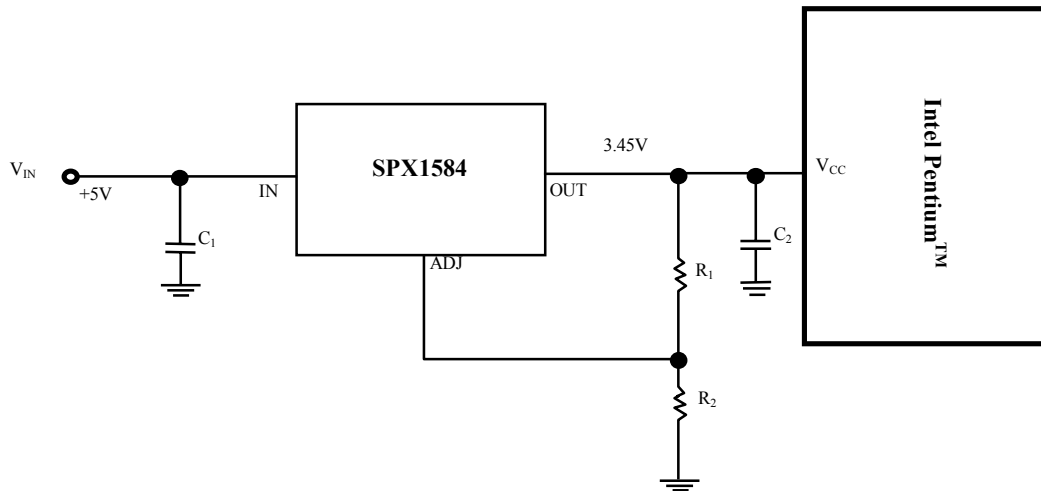

Powering Intel Pentium™ with SPX1584

Pentium Processor is a trademark of Intel Corp. Power PC is a trademark of IBM Corp.

ORDERING INFORMATION

Ordering No.	Precision	Output Voltage	Packages
SPX1584U	2%	Adj	3 Lead TO-220
SPX1584U-3.3	2%	3.3V	3 Lead TO-220
SPX1584AU	1%	Adj	3 Lead TO-220
SPX1584AU-3.3	1%	3.3V	3 Lead TO-220



SIGNAL PROCESSING EXCELLENCE

Sipex Corporation

Headquarters and Main Offices:

22 Linnell Circle
Billerica, MA 01821
TEL: (978) 667-8700
FAX: (978) 670-9001
e-mail: sales@sipex.com

233 South Hillview Drive
Milpitas, CA 95035
TEL: (408) 935-7600
FAX: (408) 934-7500

Sipex Corporation reserves the right to make changes to any products described herein. Sipex does not assume any liability arising out of the application or use of any product or circuit described hereing; neither does it convey any license under its patent rights nor the rights of others.