

## SF RERAYS Slim type

### Slim type Safety relay compliant with Safety standards

[Protective construction] Flux-resistant type

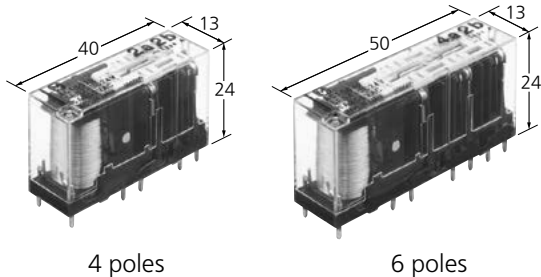

4 poles

6 poles

(Unit: mm)

#### FEATURES

- Acquisition of Korean safety certification "S mark"  
Excluding with diode type
- Forcibly guided contact structure
- Slim profile: Length ( 40/50 mm ) × Width ( 13 mm ) × Height ( 24 mm )
- Fast response time is achieved ( Max. 8 ms )
- With diode and LED indication type available
- Sockets and terminal sockets ( spade and ring tongue terminals compatible ) are available.

#### TYPICAL APPLICATIONS

- Machine tools
- Robots
- Safety PLCs
- Circuits with stringent safety standard requirements such as those in motor vehicle production equipment.

#### ORDERING INFORMATION ( PART NO. )

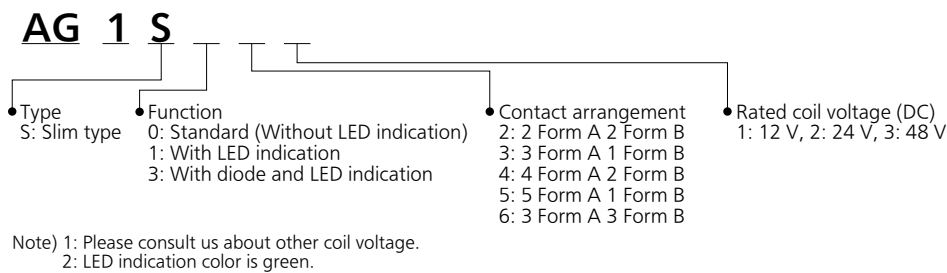

#### ORDERING INFORMATION ( TYPE NO. )

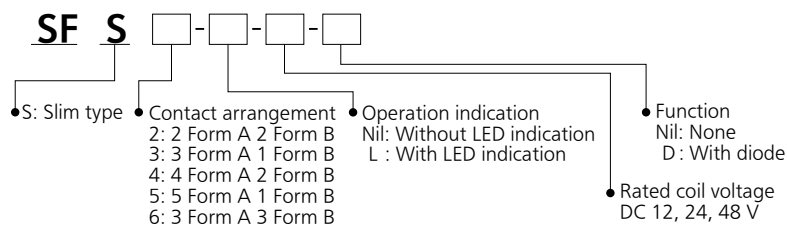

# Safety Relays SF RERAYS Slim type

## TYPES

- Standard ( without LED indication )
- PC board terminal: Carton packing

Contact arrangement		Rated coil voltage	Type No.	Part No.	Standard packing	
					Inner carton	Outer carton
4 poles	2 Form A 2 Form B	12 V DC	SFS2-DC12V	AG1S021	50 pcs.	200 pcs.
		24 V DC	SFS2-DC24V	AG1S022 ( E )		
		48 V DC	SFS2-DC48V	AG1S023		
	3 Form A 1 Form B	12 V DC	SFS3-DC12V	AG1S031		
		24 V DC	SFS3-DC24V	AG1S032 ( E )		
		48 V DC	SFS3-DC48V	AG1S033		
6 poles	4 Form A 2 Form B	12 V DC	SFS4-DC12V	AG1S041		
		24 V DC	SFS4-DC24V	AG1S042 ( E )		
		48 V DC	SFS4-DC48V	AG1S043		
	5 Form A 1 Form B	12 V DC	SFS5-DC12V	AG1S051		
		24 V DC	SFS5-DC24V	AG1S052 ( E )		
		48 V DC	SFS5-DC48V	AG1S053		
	3 Form A 3 Form B	12 V DC	SFS6-DC12V	AG1S061		
		24 V DC	SFS6-DC24V	AG1S062 ( E )		
		48 V DC	SFS6-DC48V	AG1S063		

Note) For products in units of 10 pieces of inner carton, please add "E" to the end of the part number ( only applies to 24 V products ).  
The "E" part number suffix will appear only on the inner and outer cartons and not on the relay itself.

- With LED indication
- PC board terminal: Carton packing

Contact arrangement		Rated coil voltage	Type No.	Part No.	Standard packing	
					Inner carton	Outer carton
4 poles	2 Form A 2 Form B	12 V DC	SFS2-L-DC12V	AG1S121	50 pcs.	200 pcs.
		24 V DC	SFS2-L-DC24V	AG1S122 ( E )		
		48 V DC	SFS2-L-DC48V	AG1S123		
	3 Form A 1 Form B	12 V DC	SFS3-L-DC12V	AG1S131		
		24 V DC	SFS3-L-DC24V	AG1S132 ( E )		
		48 V DC	SFS3-L-DC48V	AG1S133		
6 poles	4 Form A 2 Form B	12 V DC	SFS4-L-DC12V	AG1S141		
		24 V DC	SFS4-L-DC24V	AG1S142 ( E )		
		48 V DC	SFS4-L-DC48V	AG1S143		
	5 Form A 1 Form B	12 V DC	SFS5-L-DC12V	AG1S151		
		24 V DC	SFS5-L-DC24V	AG1S152 ( E )		
		48 V DC	SFS5-L-DC48V	AG1S153		
	3 Form A 3 Form B	12 V DC	SFS6-L-DC12V	AG1S161		
		24 V DC	SFS6-L-DC24V	AG1S162 ( E )		
		48 V DC	SFS6-L-DC48V	AG1S163		

Note) For products in units of 10 pieces of inner carton, please add "E" to the end of the part number ( only applies to 24 V products ).  
The "E" part number suffix will appear only on the inner and outer cartons and not on the relay itself.

■ With LED indication: with diode type

● PC board terminal: Carton packing

Contact arrangement		Rated coil voltage	Type No.	Part No.	Standard packing	
					Inner carton	Outer carton
4 poles	2 Form A 2 Form B	12 V DC	SFS2-L-DC12V-D	AG1S321	50 pcs.	200 pcs.
		24 V DC	SFS2-L-DC24V-D	AG1S322 ( E )		
		48 V DC	SFS2-L-DC48V-D	AG1S323		
	3 Form A 1 Form B	12 V DC	SFS3-L-DC12V-D	AG1S331		
		24 V DC	SFS3-L-DC24V-D	AG1S332 ( E )		
		48 V DC	SFS3-L-DC48V-D	AG1S333		
6 poles	4 Form A 2 Form B	12 V DC	SFS4-L-DC12V-D	AG1S341		
		24 V DC	SFS4-L-DC24V-D	AG1S342 ( E )		
		48 V DC	SFS4-L-DC48V-D	AG1S343		
	5 Form A 1 Form B	12 V DC	SFS5-L-DC12V-D	AG1S351		
		24 V DC	SFS5-L-DC24V-D	AG1S352 ( E )		
		48 V DC	SFS5-L-DC48V-D	AG1S353		
	3 Form A 3 Form B	12 V DC	SFS6-L-DC12V-D	AG1S361		
		24 V DC	SFS6-L-DC24V-D	AG1S362 ( E )		
		48 V DC	SFS6-L-DC48V-D	AG1S363		

Note) For products in units of 10 pieces of inner carton, please add "E" to the end of the part number ( only applies to 24 V products ).

The "E" part number suffix will appear only on the inner and outer cartons and not on the relay itself.

For sockets and terminal sockets, please read "SF RELAYS Slim type Sockets and DIN rail terminal sockets".

## RATING

### ■ Coil data

- Operating characteristics such as "Operate voltage" and "Release voltage" are influenced by mounting conditions or ambient temperature, etc.

Therefore, please use the relay within  $\pm 5\%$  of rated coil voltage.

- "Initial" means the condition of products at the time of delivery.

Contact arrangement		Rated coil voltage	Operate voltage* ( at 20°C )	Release voltage* ( at 20°C )	Rated operating current ( $\pm 10\%$ , at 20°C )	Coil resistance ( $\pm 10\%$ , at 20°C )	Rated operating power	Max. allowable voltage ( at 20°C )			
4 poles	2 Form A 2 Form B	12 V DC	Max. 75% V of rated coil voltage ( Initial )	Min. 10% V of rated coil voltage ( Initial )	30 mA	400 $\Omega$	Approx. 360 mW	110% V of rated coil voltage			
		24 V DC			15 mA	1,600 $\Omega$					
		48 V DC			7.5 mA	6,400 $\Omega$					
	3 Form A 1 Form B	12 V DC			30 mA	400 $\Omega$					
		24 V DC			15 mA	1,600 $\Omega$					
		48 V DC			7.5 mA	6,400 $\Omega$					
6 poles	4 Form A 2 Form B	12 V DC			Max. 75% V of rated coil voltage ( Initial )	Min. 10% V of rated coil voltage ( Initial )	41.7 mA		288 $\Omega$	Approx. 500 mW	110% V of rated coil voltage
		24 V DC					20.8 mA		1,152 $\Omega$		
		48 V DC					10.4 mA		4,608 $\Omega$		
	5 Form A 1 Form B	12 V DC					41.7 mA		288 $\Omega$		
		24 V DC					20.8 mA		1,152 $\Omega$		
		48 V DC					10.4 mA		4,608 $\Omega$		
	3 Form A 3 Form B	12 V DC	41.7 mA	288 $\Omega$							
		24 V DC	20.8 mA	1,152 $\Omega$							
		48 V DC	10.4 mA	4,608 $\Omega$							

Note) For with LED indication, the rated operating current will increase by approximately 2 mA due to the LED display.

\* square, pulse drive ( JIS C 5442 )

# Safety Relays SF RERAYS Slim type

## ■ Specifications

Item		Characteristics				
		4 poles		6 poles		
Contact data	Contact arrangement	2 Form A 2 Form B	3 Form A 1 Form B	4 Form A 2 Form B	5 Form A 1 Form B	3 Form A 3 Form B
	Contact resistance ( initial )	Max. 100 m Ω ( by voltage drop 6 V DC 1 A )				
	Contact material	Au flashed AgSnO <sub>2</sub> type				
	Contact rating ( resistive )	6 A 250 V AC, 6 A 30 V DC				
	Max. switching power ( resistive )	1,500 VA, 180 W				
	Max. switching voltage	250 V AC, 125 V DC				
	Max. switching current	6 A ( Reduce by 0.1 A/°C for temperatures 70 to 85°C )				
	Min. switching load ( reference value ) *1	1 mA 5 V DC				
Insulation resistance ( initial )		Min. 1,000 M Ω ( at 500 V DC, Measured portion is the same as the case of dielectric strength. )				
Dielectric strength ( initial )	Between open contacts	1,500 Vrms for 1 min ( Detection current: 10 mA )				
	Between contact sets	7-8/9-10 between open contacts 2,500 Vrms for 1 min ( detection current: 10 mA )		7-8/11-12 between open contacts 9-10/13-14 between open contacts 11-12/13-14 between open contacts 2,500 Vrms for 1 min ( detection current: 10 mA )		
		3-4/5-6 between open contacts 3-4/7-8 between open contacts 5-6/9-10 between open contacts 4,000 Vrms for 1 min ( detection current: 10 mA )		3-4/5-6 between open contacts 3-4/7-8 between open contacts 5-6/9-10 between open contacts 7-8/9-10 between open contacts 4,000 Vrms for 1 min ( detection current: 10 mA )		
	Between contact and coil	4,000 Vrms for 1 min ( detection current: 10 mA )				
Time characteristics ( initial )	Operate time	Max. 20 ms at rated coil voltage ( at 20°C , without bounce )				
	Response time*2	Max. 8 ms at rated coil voltage ( at 20°C , without bounce, without diode ) *4				
	Release time	Max. 20 ms at rated coil voltage ( at 20°C , without bounce )				
Shock resistance	Functional	200 m/s <sup>2</sup> ( half-sine shock pulse: 11 ms, detection time: 10 μs )				
	Destructive	1,000 m/s <sup>2</sup> ( half-sine shock pulse: 6 ms )				
Vibration resistance	Functional	10 to 55 Hz ( at double amplitude of 1.5 mm, detection time: 10 μs )				
	Destructive	10 to 55 Hz ( at double amplitude of 1.5 mm )				
Expected life	Mechanical life	Min. 10 <sup>7</sup> ( switching frequency: 180 times/min )				
Conditions	Conditions for usage, transport and storage*3	Ambient temperature: -40 to +85°C Humidity: 5 to 85% RH ( Avoid icing and condensation ) *5				
Unit weight		Approx. 20 g		Approx. 23 g		

\*1. This value is a rough indication of the lower limit at which switching is possible at micro load level.

This value can change due to the switching frequency, environmental conditions, and desired reliability level, therefore it is recommended to check this with the actual load.

\*2. Response time is the time after the coil voltage turns off until the time when form A contact turns off.

\*3. The upper operation ambient temperature limit is the maximum temperature that can satisfy the coil temperature rise value. For details, please read "Ambient environment in GUIDELINES FOR RELAY USAGE".

\*4. Response time of with diode type is Max. 12 ms ( without bounce when rated coil voltage is applied ).

\*5. When the temperature is 70 to 85°C , reduce the max. continuous carrying current by 0.1 A/°C .

## ■ Electrical life

Type	Load	Switching capacity	Number of operations
2 Form A 2 Form B 3 Form A 1 Form B 4 Form A 2 Form B 5 Form A 1 Form B 3 Form A 3 Form B	Resistive load	6 A 250 V AC	Min. 10 <sup>5</sup> ( switching frequency 20 times/min )
		6 A 30 V DC	Min. 10 <sup>5</sup> ( switching frequency 20 times/min )
		1 A 250 V AC	Min. 5 x 10 <sup>5</sup> ( switching frequency 30 times/min )
		1 A 30 V DC	Min. 5 x 10 <sup>5</sup> ( switching frequency 30 times/min )
	AC15: inductive load	2 A 240 V AC	Min. 10 <sup>5</sup> ( switching frequency 20 times/min , cos φ = 0.3 )
	DC13: inductive load	1 A 24 V DC	Min. 10 <sup>5</sup> ( switching frequency 20 times/min , L/R = 48 ms )

## REFERENCE DATA

### 1. Operate, response and release times

Tested sample: SFS4-DC24V (4 Form A 2 Form B), 20pcs. (a contacts: 80, b contacts: 40)

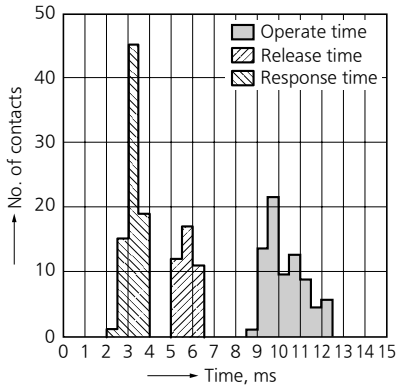

### 2. Coil temperature rise value

Tested sample: SFS4-DC24 V (4 Form A 2 Form B), 3 pcs.  
Measured portion: Inside the coil  
Ambient temperature: Room temperature (27°C), 70°C, 85°C

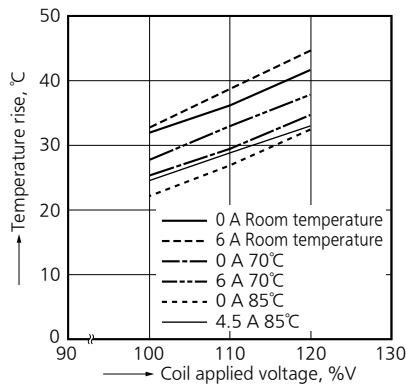

### 3. Functional shock resistance

Tested sample: SFS4-DC24V (4 Form A 2 Form B), 3pcs.

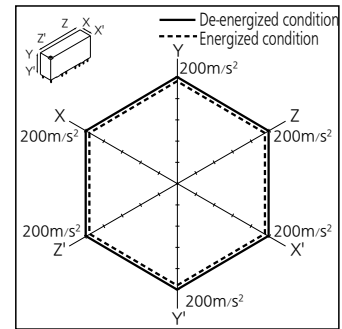

### 4. Max. switching capacity

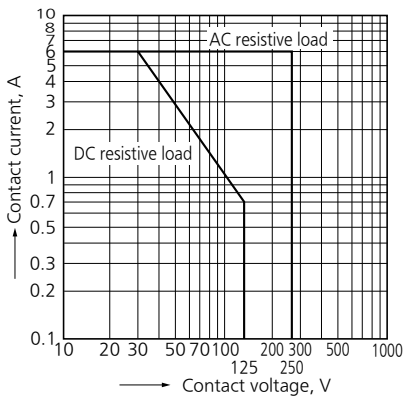

## OTHER CONTACT GAPS WHEN CONTACTS ARE WELDED

The table below shows the state of the other contacts when the current through the welded N.O. contact is 0 V and the rated voltage is applied through the welded N.C. contact.

Sample: AG1S042 (4 Form A 2 Form B)

		State of other contacts					
		3-4 (N.C.)	5-6 (N.C.)	7-8 (N.O.)	9-10 (N.O.)	11-12 (N.O.)	13-14 (N.O.)
Welded terminal No.	3-4 (N.C.)	—		> 0.5	> 0.5	> 0.5	> 0.5
	5-6 (N.C.)		—	> 0.5	> 0.5	> 0.5	> 0.5
	7-8 (N.O.)	> 0.5	> 0.5	—			
	9-10 (N.O.)	> 0.5	> 0.5		—		
	11-12 (N.O.)	> 0.5	> 0.5			—	
	13-14 (N.O.)	> 0.5	> 0.5				—

>0.5: Contact gap Min. 0.5 mm

Empty cells: Contact is ON or OFF state.

Note) Contact gaps are shown at the initial state. If the contacts change state owing to load switching it is necessary to check the actual loading.

# Safety Relays SF RERAYS Slim type

## DIMENSIONS

**CAD** The CAD data of the products with a "CAD" mark can be downloaded from our Website.

Unit: mm

### 4 poles ( 2 Form A 2 Form B, 3 Form A 1 Form B )

#### CAD

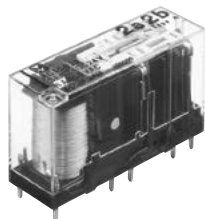

External dimensions

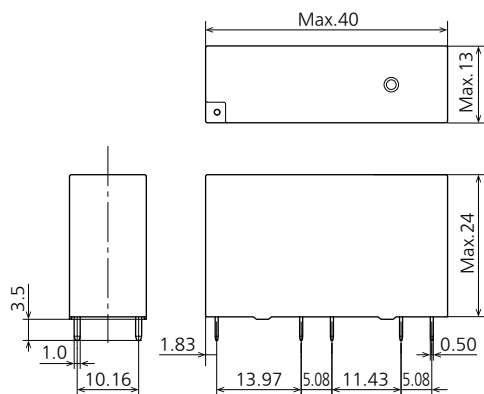

Recommended PC board pattern ( BOTTOM VIEW )

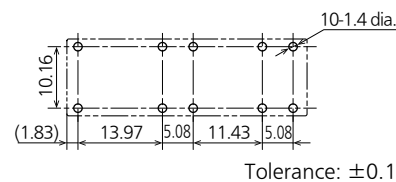

Schematic ( BOTTOM VIEW )

Standard

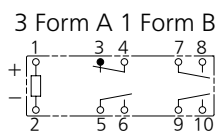
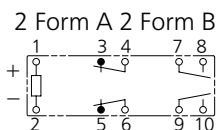

With LED indication

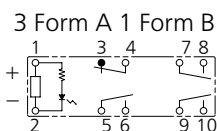
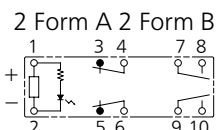

With diode and LED indication type

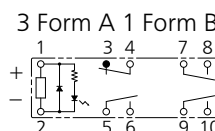
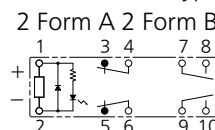

General tolerance: ±0.3

### 6 poles ( 4 Form A 2 Form B, 5 Form A 1 Form B, 3 Form A 3 Form B )

#### CAD

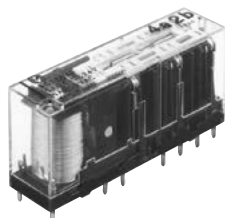

External dimensions

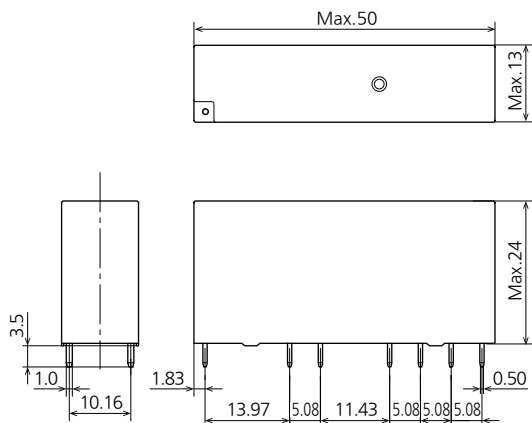

Recommended PC board pattern ( BOTTOM VIEW )

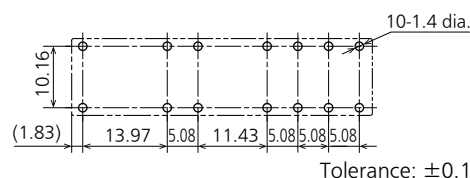

Schematic ( BOTTOM VIEW )

Standard

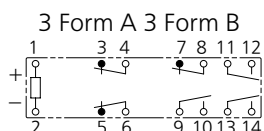
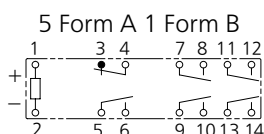
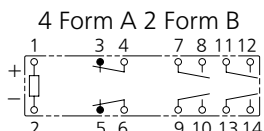

With LED indication

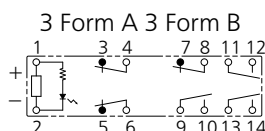
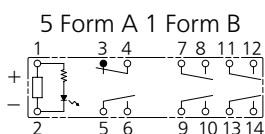
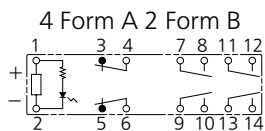

With diode and LED indication type

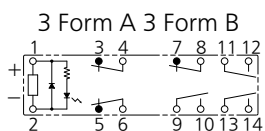
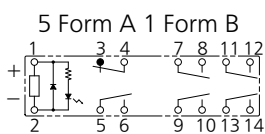
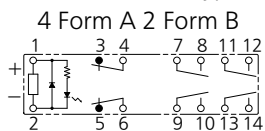

General tolerance: ±0.3

## SAFETY STANDARDS

### UL/C-UL ( Recognized )

File No.	Contact rating
E43149	6 A 277 V AC
	6 A 30 V DC

### CSA ( Certified )

CSA standard certified by C-UL

### TÜV ( Certified )

File No.	Contact rating
B1803 13461 382	6 A 250 V AC ( $\cos \phi = 1.0$ )
	6 A 30 V DC ( 0 ms )
	AC 15: 2 A 240 V AC ( $\cos \phi = 0.3$ )
	DC 13: 1 A 24 V DC ( L/R 48 ms )

### CQC ( Certified )

File No.	Contact rating
CQC10002044376	6 A 250 V AC

## GUIDELINES FOR USAGE

### For cautions for use, please read "GUIDELINES FOR RELAY USAGE".

[https://industrial.panasonic.com/ac/e/control/relay/cautions\\_use/index.jsp](https://industrial.panasonic.com/ac/e/control/relay/cautions_use/index.jsp)

### For cautions for use SF relays slim type

#### ● Coil drive power supply

Pure DC current should be applied to the coil. If it includes ripple, the ripple factor should be less than 5%. However, check it with the actual circuit since the characteristics may be slightly different. The power wave form should be rectangular.

#### ● Connection of coil

The positive ( + ) and negative ( - ) connections of polarized relay to the coil should be done as indicated on the schematic diagram. If connected incorrectly, it may malfunction or fail to operate.

#### ● Cleaning

This relay is not sealed, therefore, whole washing may cause failure. Be careful that flux does not overflow onto the PC board or penetrate inside the relay.

#### ● Soldering

When using automatic soldering, the following conditions are recommended

- 1 ) Preheating: 120°C , within 120 sec
- 2 ) Soldering: 260 ±5°C , within 6 sec

#### ● Please connect DC coil types with LED indication and with diode type correctly by verifying the coil polarity ( + ) ( - ).

Connecting with reverse polarity will cause the LED not to light and damage the built-in diode due to its specification.

#### ● Conditions for usage, transport and storage

- 1 ) Temperature: -40 to +85°C  
( When the temperature is 70 to 85°C , reduce the Max. 6 A. switching current by 0.1 A/°C . )
- 2 ) Humidity: 5 to 85% RH  
( Avoid icing and condensation )  
Note: The humidity range varies with the temperature. Use within the range indicated in the graph.
- 3 ) Air pressure: 86 to 106 kPa

[Temperature and humidity range for usage, transport, and storage]

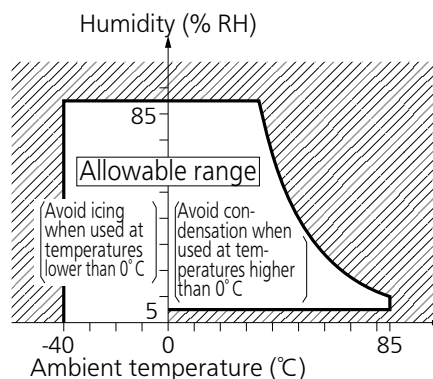

## Safety Relays SF RERAYS Slim type

---

### ● Others handling precautions

- Do not use relays that have been dropped, because doing so may be a cause of faulty operation. If the relay has been dropped, the appearance and characteristics should always be checked before use.
- The expected life is specified under the standard test conditions in the JIS C 5442-1996 ( temperature 15 to 35°C , humidity 25 to 75% RH )  
Expected life is dependent on the coil driving circuit, load type, switching frequency, ambient environment and atmosphere. Check expected life under the actual condition. Also, be especially careful with loads such as those listed below.
  - 1 ) When used for AC load switching and the switching phase is synchronous.  
Rocking and welding can easily occur due to contact shifting.
  - 2 ) High frequency load switching  
During high frequency switching with certain loads, arcing may occur at the contacts. This can cause fusion to Oxygen and Nitrogen gas in the air creating Nitric Acid (  $\text{HNO}_3$  ) which can cause corrosion to the metal material.  
Please see the following countermeasure examples:
    - ( 1 ) Incorporate an arc-extinguishing circuit
    - ( 2 ) Lower the switching frequency
    - ( 3 ) Lower the humidity of ambient atmosphere
- For secure operations, rated coil voltage should be applied to the coil. In addition, please note that operate and release voltages will vary according to the ambient temperature and operating conditions.
- Abnormal heat, smoke, and/or fire may occur if the relay is used outside the allowable ranges for the coil ratings, contact ratings, expected life and other specifications.
- Incorrect wiring may cause unexpected malfunction, abnormal heat or fire.
- Check the ambient atmosphere when storing or transporting the relays and devices containing the relays. Icing or condensation may occur in the relay causing damage. Avoid exposing the relays to heavy loads, or strong shock and vibration.

Please refer to "**the latest product specifications**" when designing your product.

- Requests to customers:  
<https://industrial.panasonic.com/ac/e/salespolicies/>



# SF RELAYS Slim type Sockets/DIN rail terminal sockets



## TYPES

### ■ Sockets

Type	Number of poles	Type No.	Part No.	Standard packing	
				Inner carton	Outer carton
PC board sockets	For 4 poles	SFS4-PS	AG1S844	10 pcs.	100 pcs.
	For 6 poles	SFS6-PS	AG1S864		

### ■ DIN rail terminal socket

Type	Number of poles	Type No.	Part No.	Standard packing	
				Inner carton	Outer carton
Terminal sockets for spade and ring tongue terminals	For 4 poles	SFS4-SFD-R	AG1S848	10 pcs.	100 pcs.
	For 6 poles	SFS6-SFD-R	AG1S868		

Note) Spade tongue terminal dedicated terminal sockets, please order AG1S847 for 4 poles and AG1S867 for 6 poles.

## RATING

### ■ Specifications

Item	Specifications
Dielectric strength ( initial )	Between each terminal 2,500 V AC for 1 min ( detection current: 10 mA )
Insulation resistance ( initial )	Min. 1,000 MΩ ( at 500 V DC, Measured portion is the same as the case of dielectric strength. )
Max. continuous carrying current	6 A ( Reduce by 0.1 A/°C for temperatures 70 to 85°C )
Conditions for usage, transport and storage	Ambient temperature: -40 to 85°C , Humidity 5 to 85% RH ( Avoid icing and condensation )

## DIMENSIONS

**CAD** The CAD data of the products with a "CAD" mark can be downloaded from our Website.

Unit: mm

### ■ PC board sockets

- For 4 poles: AG1S844

#### CAD

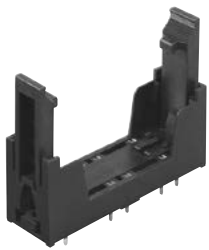

External dimensions

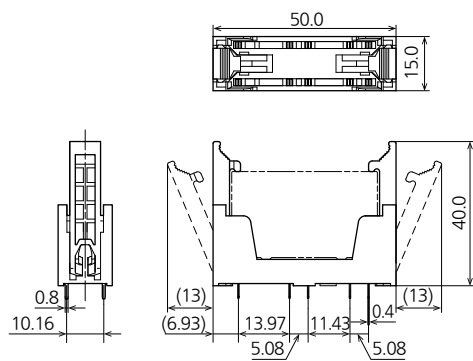

General tolerance: ±0.3

Recommended PC board pattern ( BOTTOM VIEW )

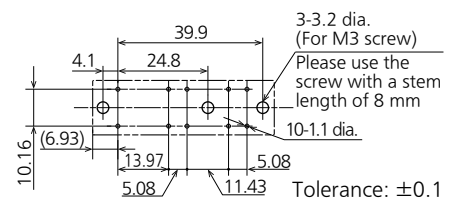

Schematic ( BOTTOM VIEW )

Standard

With LED indication

With diode and LED indication type

2 Form A 2 Form B mounted

2 Form A 2 Form B mounted

2 Form A 2 Form B mounted

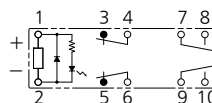
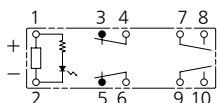
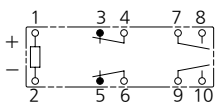

3 Form A 1 Form B mounted

3 Form A 1 Form B mounted

3 Form A 1 Form B mounted

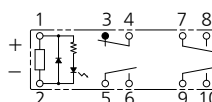
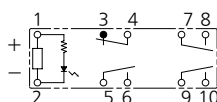
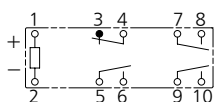

# Safety Relays SF RERAYS Slim type

● For 6 poles: AG1S864

**CAD**

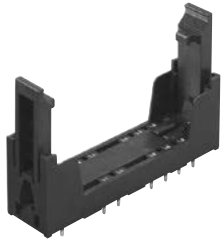

External dimensions

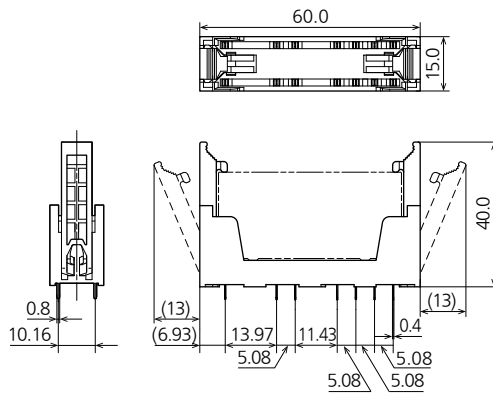

General tolerance:  $\pm 0.3$

Recommended PC board pattern  
( BOTTOM VIEW )

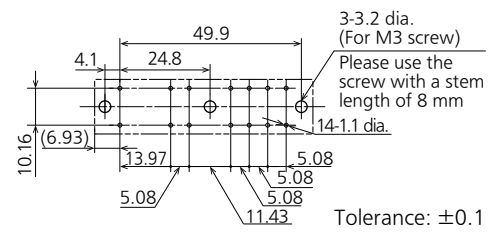

Schematic ( BOTTOM VIEW )

Standard

With LED indication

With diode and  
LED indication type

4 Form A 2 Form B mounted

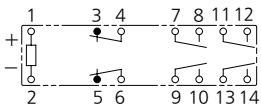

4 Form A 2 Form B mounted

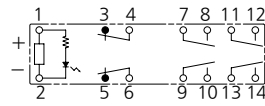

4 Form A 2 Form B mounted

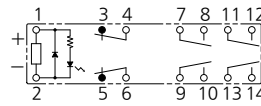

5 Form A 1 Form B mounted

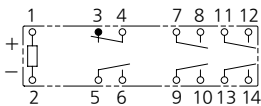

5 Form A 1 Form B mounted

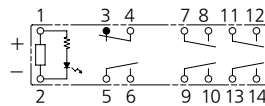

5 Form A 1 Form B mounted

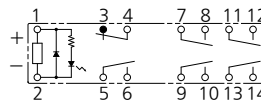

3 Form A 3 Form B mounted

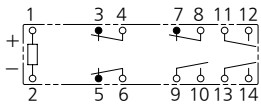

3 Form A 3 Form B mounted

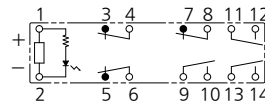

3 Form A 3 Form B mounted

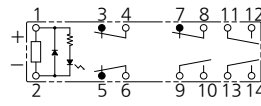

# Safety Relays SF RERAYS Slim type

■ Terminal socket for spade and ring tongue terminals ( finger protect type )

● For 4 poles: AG1S848

**CAD**

External dimensions

Mounting hole pattern

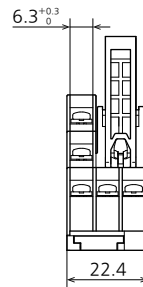
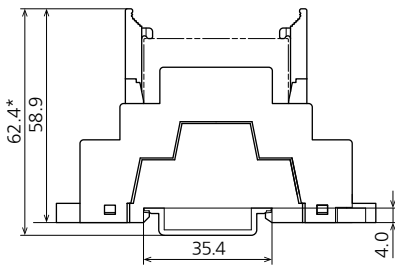
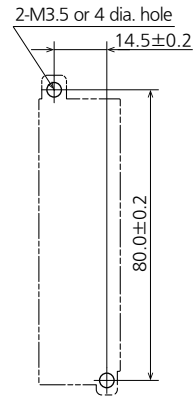
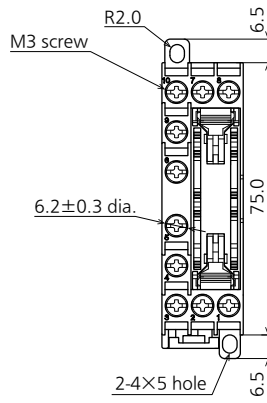
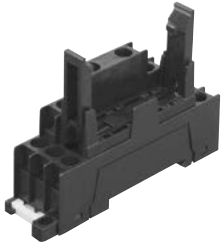

General tolerance: ±0.5

Tolerance: ±0.1

Schematic ( TOP VIEW )

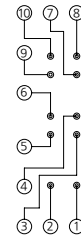

\* Reference value (when using DIN rail ATA48011)  
 Note) Ring tongue terminals cannot be used AG1S847.  
 In use of a ring tongue terminals, please use AG1S848.

● For 6 poles: AG1S868

**CAD**

External dimensions

Mounting hole pattern

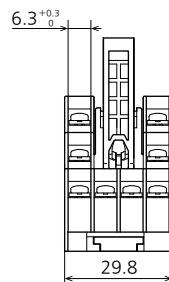
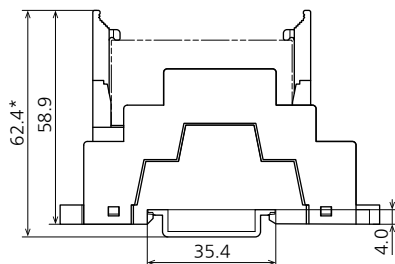
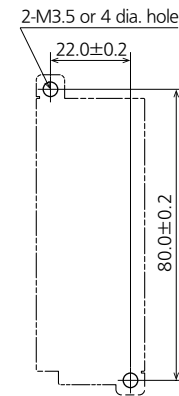
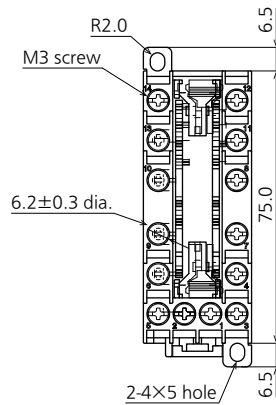
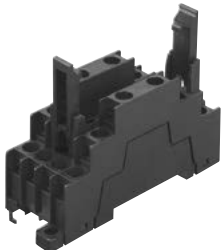

General tolerance: ±0.5

Tolerance: ±0.1

Schematic ( TOP VIEW )

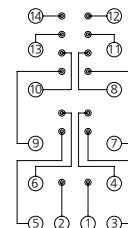

\* Reference value (when using DIN rail ATA48011)  
 Note) Ring tongue terminals cannot be used AG1S867.  
 In use of a ring tongue terminals, please use AG1S868.

# Safety Relays SF RERAYS Slim type

## SAFETY STANDARDS

### ■ UL/C-UL ( Recognized )

File No.
E148103

### ■ TÜV ( Certified )

File No.
B 013461 0318 Rev.01

## GUIDELINES FOR USAGE

### ■ Installation on DIN rail

1 ) Attach directly to the chassis or use a DIN rail.

( 1 ) When attaching directly to chassis

- Use a M3.5 screw, spring washer, and hex nut.
- For the mounting pitch, refer to the dimensions.

( 2 ) When installing on a DIN rail

- Use a 35 mm wide DIN rail ( DIN46277 ).
- Install and remove as shown in the figures.

< When installing >

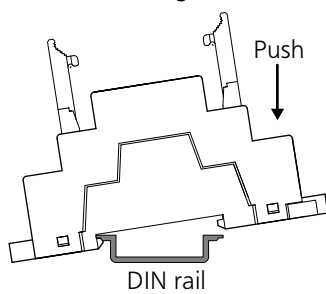

< When removing >

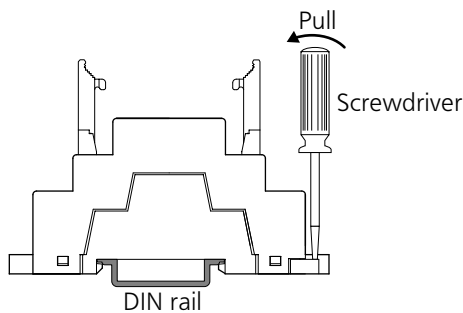

2 ) Refer to the figure for applicable solderless terminals.

Spade tongue terminal

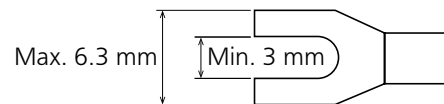

Ring tongue terminal

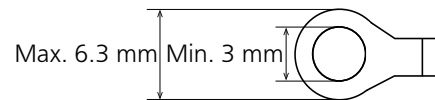

Please refer to "the latest product specifications" when designing your product.

- Requests to customers:

<https://industrial.panasonic.com/ac/e/salespolicies/>

# GUIDELINES FOR POWER, HIGH-CAPACITY DC CUT OFF AND SAFETY RELAYS USAGE

■ For cautions for use, please read “GUIDELINES FOR RELAY USAGE”.  
[https://industrial.panasonic.com/ac/e/control/relay/cautions\\_use/index.jsp](https://industrial.panasonic.com/ac/e/control/relay/cautions_use/index.jsp)

## Precautions for Coil Input

### ■ Long term current carrying

A circuit that will be carrying a current continuously for long periods without relay switching operation. (circuits for emergency lamps, alarm devices and error inspection that, for example, revert only during malfunction and output warnings with form B contacts)  
Continuous, long-term current to the coil will facilitate deterioration of coil insulation and characteristics due to heating of the coil itself. For circuits such as these, please use a magnetic-hold type latching relay. If you need to use a single stable relay, use a sealed type relay that is not easily affected by ambient conditions and make a failsafe circuit design that considers the possibility of contact failure or disconnection.

### ■ DC Coil operating power

Steady state DC current should be applied to the coil. The wave form should be rectangular. If it includes ripple, the ripple factor should be less than 5%.  
However, please check with the actual circuit since the electrical characteristics may vary. The rated coil voltage should be applied to the coil and the set/reset pulse time of latching type relay differs for each relays, please refer to the relay's individual specifications.

### ■ Coil connection

When connecting coils of polarized relays, please check coil polarity (+,-) at the internal connection diagram (Schematic). If any wrong connection is made, it may cause unexpected malfunction, like abnormal heat, fire and so on, and circuit do not work. Avoid impressing voltages to the set coil and reset coil at the same time.

### ■ Maximum allowable voltage and temperature rise

Proper usage requires that the rated coil voltage be impressed on the coil. Note, however, that if a voltage greater than or equal to the maximum continuous voltage is impressed on the coil, the coil may burn or its layers short due to the temperature rise. Furthermore, do not exceed the usable ambient temperature range listed in the catalog.

### ■ Operate voltage change due to coil temperature rise

In DC relays, after continuous passage of current in the coil, if the current is turned OFF, then immediately turned ON again, due to the temperature rise in the coil, the pick-up voltage will become somewhat higher. Also, it will be the same as using it in a higher temperature atmosphere. The resistance/temperature relationship for copper wire is about 0.4% for 1°C, and with this ratio the coil resistance increases. That is, in order to operate of the relay, it is necessary that the voltage be higher than the pick-up voltage and the pick-up voltage rises in accordance with the increase in the resistance value. However, for some polarized relays, this rate of change is considerably smaller.

## Ambient Environment

### ■ Usage, Transport, and Storage Conditions

During usage, storage, or transportation, avoid locations subjected to direct sunlight and maintain normal temperature, humidity and pressure conditions.

### ● Temperature/Humidity/Pressure

When transporting or storing relays while they are tube packaged, there are cases the temperature may differ from the allowable range. In this case be sure to check the individual specifications. Also allowable humidity level is influenced by temperature, please check charts shown below and use relays within mentioned conditions. (Allowable temperature values differ for each relays, please refer to the relay's individual specifications.)

#### 1) Temperature:

The tolerance temperature range differs for each relays, please refer to the relay's individual specifications

#### 2) Humidity: 5 to 85 % RH

#### 3) Pressure: 86 to 106 kPa

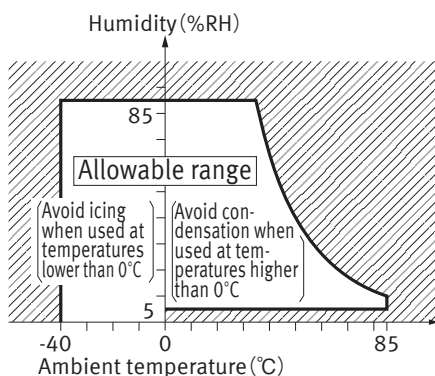

### ● Dew condensation

Condensation occurs when the ambient temperature drops suddenly from a high temperature and humidity, or the relay is suddenly transferred from a low ambient temperature to a high temperature and humidity. Condensation causes the failures like insulation deterioration, wire disconnection and rust etc. Panasonic Corporation does not guarantee the failures caused by condensation.

The heat conduction by the equipment may accelerate the cooling of device itself, and the condensation may occur.

Please conduct product evaluations in the worst condition of the actual usage. (Special attention should be paid when high temperature heating parts are close to the device. Also please consider the condensation may occur inside of the device.)

### ● Icing

Condensation or other moisture may freeze on relays when the temperature become lower than 0°C. This icing causes the sticking of movable portion, the operation delay and the contact conduction failure etc. Panasonic Corporation does not guarantee the failures caused by the icing.

The heat conduction by the equipment may accelerate the cooling of relay itself and the icing may occur. Please conduct product evaluations in the worst condition of the actual usage.

### ● Low temperature and low humidity

The plastic becomes brittle if the switch is exposed to a low temperature, low humidity environment for long periods of time.

### ● High temperature and high humidity

Storage for extended periods of time (including transportation periods) at high temperature or high humidity levels or in atmospheres with organic gases or sulfide gases may cause a sulfide film or oxide film to form on the surfaces of the contacts and/or it may interfere with the functions. Check out the atmosphere in which the units are to be stored and transported.

## ● Package

In terms of the packing format used, make every effort to keep the effects of moisture, organic gases and sulfide gases to the absolute minimum.

## ● Silicon

When a source of silicone substances (silicone rubber, silicone oil, silicone coating materials and silicone filling materials etc.) is used around the relay, the silicone gas (low molecular siloxane etc.) may be produced.

This silicone gas may penetrate into the inside of the relay. When the relay is kept and used in this condition, silicone compound may adhere to the relay contacts which may cause the contact failure.

Do not use any sources of silicone gas around the relay (Including plastic seal types).

## ● NOx Generation

When relay is used in an atmosphere high in humidity to switch a load which easily produces an arc, the NOx created by the arc and the water absorbed from outside the relay combine to produce nitric acid.

This corrodes the internal metal parts and adversely affects operation.

Avoid use at an ambient humidity of 85%RH or higher (at 20°C). If use at high humidity is unavoidable, please contact our sales representative.

## Others

### ■ Cleaning

• Although the environmentally sealed type relay (plastic sealed type, etc.) can be cleaned, avoid immersing the relay into cold liquid (such as cleaning solvent) immediately after soldering. Doing so may deteriorate the sealing performance.

• Cleaning with the boiling method is recommended(The temperature of cleaning liquid should be 40°C or lower ).

Avoid ultrasonic cleaning on relays. Use of ultrasonic cleaning may cause breaks in the coil or slight sticking of the contacts due to ultrasonic energy.

Please refer to **"the latest product specifications"** when designing your product.

•Requests to customers:

<https://industrial.panasonic.com/ac/e/salespolicies/>

---

Please contact .....

**Panasonic Corporation**

Electromechanical Control Business Division

■1006, Oaza Kadoma, Kadoma-shi, Osaka 571-8506, Japan  
[industrial.panasonic.com/ac/e/](http://industrial.panasonic.com/ac/e/)

**Panasonic**<sup>®</sup>

©Panasonic Corporation 2020