

Description

ACE302 is a series of high precision voltage detector with ultra low current consumption (500nA typ. at Vdd=3.0V) and a built-in delay circuit. It can work at very low voltage, which makes it perfect for system reset.

ACE302 is composed of high precision voltage reference, comparator, delay circuit, output driver and resistor array. Internally preset detect voltage has a low temperature drift and requires no external trimming.

Two type of output, CMOS and N-channel open-drain are available.

ACE302 is available in SOT-23-3 which is Pb free.

Features

- High-precision detection Voltage : $\pm 2\%$
- Detection Voltage : 0.9V~6.0V (in 0.1V steps)
- Built-in Power on Reset Delay Time circuit::Refer to Selection Guide
- Operating Voltage range : 0.7V~10V
- Ultra-low current consumption : 500nA typ. (at VDD = 3.0V)
- Two Output forms : CMOS and N-channel open-drain (Active Low)

Application

- Power monitor for portable equipment such as PDA,DSC,Mobile phone,Notebook,MP3
- CPU and Logic Circuit Reset
- Battery Checker
- Battery Back-up Circuit
- Power Failure Detector

Absolute Maximum Ratings

Parameter	Symbol	Max	Unit
Input Voltage		-0.3~12	V
Output Voltage		-0.3~12	V
Output Current		70	mA
Power Dissipation		150	mW
Ambient temperature		-40~85	°C
Storage temperature		-40~125	°C

Packaging Type

SOT-23-3

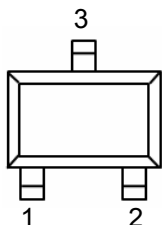

Pin No	Symbol	Description
1	V_{SS}	GND Pin
2	V_{OUT}	Voltage detection output pin
3	V_{DD}	Voltage input Pin

Ordering information

Selection Guide

ACE302 X XXX X XX + H

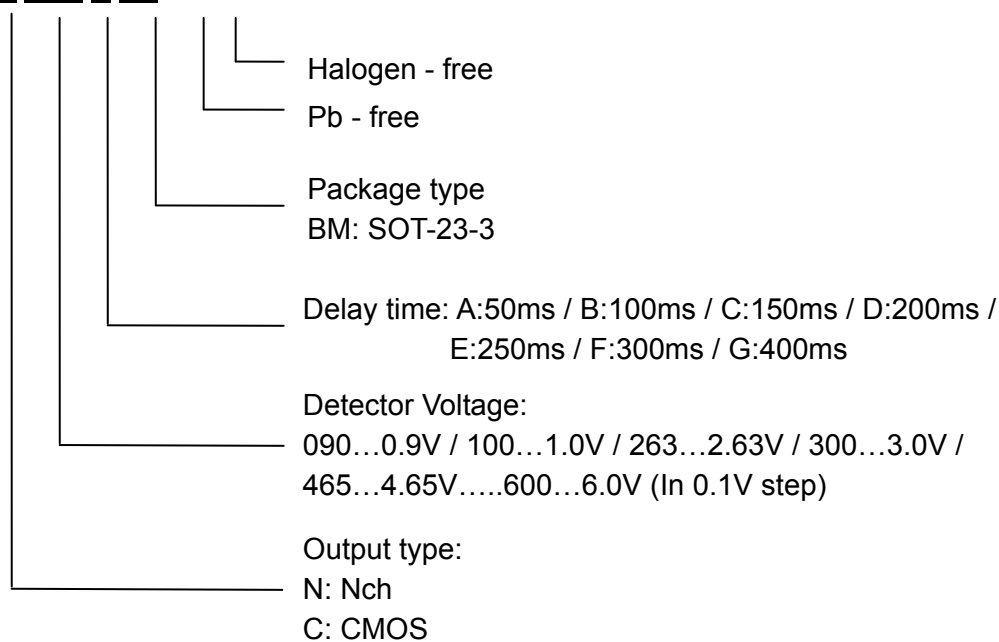

Recommended Work Conditions

Item	Min	Typ.	Max	Unit
Input Voltage (V_{in})	0.7		10	V
Ambient Temperature (T_j)	-40	25	85	°C

Block diagram

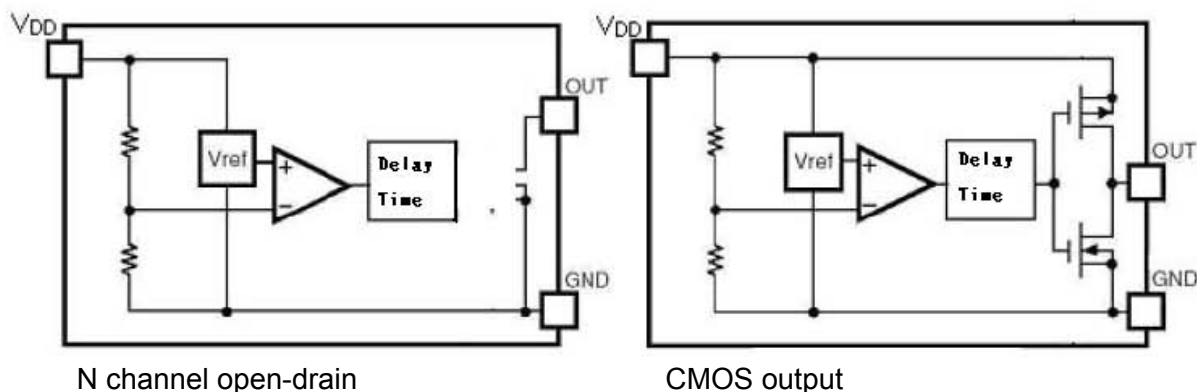

Electrical Characteristics

ACE302N090DBM+ (0.9V) (T_{opt}=25°C, Unless otherwise specified)

Symbol	Parameter	Conditions	Reference data			Unit
			Min.	Typ.	Max.	
-V _{DET}	Detector Threshold		0.882	0.9	0.918	V
I _{SS}	Current consumption	V _{DD} =2.9V		1	1.5	μA
V _{DDH}	Maximum operating voltage				10	V
V _{DDL}	Minimum Operating voltage			0.5		V
I _{OUT}	Output current	Nch V _{DS} =0.05V, V _{DD} =0.7V V _{DS} =0.50V, V _{DD} =0.8V	0.01 0.05	0.05 0.50		mA
		Pch V _{DS} =-2.1V, V _{DD} =4.50V	1.0	2.0		mA

ACE302N270DBM+ (2.7V) (T_{opt}=25°C, Unless otherwise specified)

Symbol	Parameter	Conditions	Reference data			Unit
			Min.	Typ.	Max.	
-V _{DET}	Detector Threshold		2.646	2.7	2.754	V
I _{SS}	Current consumption	V _{DD} =4.7V		0.5	1	μA
V _{DDH}	Maximum operating voltage				10	V
V _{DDL}	Minimum Operating voltage			0.5		V
I _{OUT}	Output current	Nch V _{DS} =0.05V, V _{DD} =0.7V	0.01	0.05		mA
		Pch V _{DS} =-2.1V, V _{DD} =4.50V	1.0	2.0		mA

ACE302N300DBM+ (3.0V) (T_{opt}=25°C, Unless otherwise specified)

Symbol	Parameter	Conditions	Reference data			Unit
			Min.	Typ.	Max.	
-V _{DET}	Detector Threshold		2.94	3.0	3.06	V
I _{SS}	Current consumption	V _{DD} =5.0V		0.5	1	uA
V _{DDH}	Maximum operating voltage				10	V
V _{DDL}	Minimum Operating voltage			0.5		V
I _{OUT}	Output current	Nch V _{DS} =0.05V, V _{DD} =0.7V	0.01	0.05		mA
		Pch V _{DS} =-2.1V, V _{DD} =4.50V	1.0	2.0		mA

ACE302N340DBM+ (3.4V) (T_{opt}=25°C, Unless otherwise specified)

Symbol	Parameter	Conditions	Reference data			Unit
			Min.	Typ.	Max.	
-V _{DET}	Detector Threshold		3.332	3.4	3.468	V
I _{SS}	Current consumption	V _{DD} =5.0V		0.5	1	uA
V _{DDH}	Maximum operating voltage				10	V
V _{DDL}	Minimum Operating voltage			0.5		V
I _{OUT}	Output current	Nch V _{DS} =0.05V, V _{DD} =0.7V	0.01	0.05		mA
		Pch V _{DS} =-2.1V, V _{DD} =4.50V	1.0	2.0		mA

ACE302N440DBM+ (4.4V) (T_{opt}=25°C, Unless otherwise specified)

Symbol	Parameter	Conditions	Reference data			Unit
			Min.	Typ.	Max.	
-V _{DET}	Detector Threshold		4.312	4.4	4.488	V
I _{SS}	Current consumption	V _{DD} =6.4V		0.5	1	uA
V _{DDH}	Maximum operating voltage				10	V
V _{DDL}	Minimum Operating voltage			0.5		V
I _{OUT}	Output current	Nch V _{DS} =0.05V, V _{DD} =0.7V	0.01	0.05		mA
		Pch V _{DS} =-2.1V, V _{DD} =8.0V	1.5	3.0		mA

Electrical Characteristics By Detector Threshold

Part Number	Detector Threshold			Supply Current1			Supply Current2		
	-Vdet[V]			Iss1[uA]			Iss2[uA]		
	Min	Typ	Max	Condition	Typ	Max	Condition	Typ	Max
ACE302X090XXX+	0.882	0.900	0.918	Vdd= (-Vdet) +0.1V	0.5	1.0	Vdd= (-Vdet) +2V	1.0	1.5
ACE302X100XXX+	0.980	1.000	1.020						
ACE302X110XXX+	1.078	1.100	1.122						
ACE302X120XXX+	1.176	1.200	1.224						
ACE302X130XXX+	1.274	1.300	1.326						
ACE302X140XXX+	1.372	1.400	1.428						
ACE302X150XXX+	1.470	1.500	1.530						
ACE302X160XXX+	1.568	1.600	1.632						
ACE302X170XXX+	1.666	1.700	1.734						
ACE302X180XXX+	1.764	1.800	1.836						
ACE302X190XXX+	1.862	1.900	1.938						
ACE302X200XXX+	1.960	2.000	2.040						
ACE302X210XXX+	2.058	2.100	2.142						
ACE302X220XXX+	2.156	2.200	2.244						
ACE302X230XXX+	2.254	2.300	2.346						
ACE302X240XXX+	2.352	2.400	2.448						
ACE302X250XXX+	2.450	2.500	2.550						
ACE302X260XXX+	2.548	2.600	2.652						
ACE302X270XXX+	2.646	2.700	2.754						
ACE302X280XXX+	2.744	2.800	2.856						
ACE302X290XXX+	2.842	2.900	2.958						
ACE302X300XXX+	2.940	3.000	3.060						
ACE302X310XXX+	3.038	3.100	3.162						
ACE302X320XXX+	3.136	3.200	3.264						
ACE302X330XXX+	3.234	3.300	3.366						
ACE302X340XXX+	3.332	3.400	3.468						
ACE302X350XXX+	3.430	3.500	3.570						
ACE302X360XXX+	3.528	3.600	3.672						
ACE302X370XXX+	3.626	3.700	3.774						
ACE302X380XXX+	3.724	3.800	3.876						
ACE302X390XXX+	3.822	3.900	3.978						
ACE302X400XXX+	3.920	4.000	4.080						
ACE302X410XXX+	4.018	4.100	4.182						
ACE302X420XXX+	4.116	4.200	4.284						

ACE302X430XXX+	4.214	4.300	4.386						
ACE302X440XXX+	4.312	4.400	4.488						
ACE302X450XXX+	4.410	4.500	4.590						
ACE302X460XXX+	4.508	4.600	4.692						
ACE302X470XXX+	4.606	4.700	4.794						
ACE302X480XXX+	4.704	4.800	4.896						
ACE302X490XXX+	4.802	4.900	4.998						
ACE302X500XXX+	4.900	5.000	5.100						
ACE302X510XXX+	4.998	5.100	5.202						
ACE302X520XXX+	5.096	5.200	5.304						
ACE302X530XXX+	5.194	5.300	5.406						
ACE302X540XXX+	5.292	5.400	5.508						
ACE302X550XXX+	5.390	5.500	5.610						
ACE302X560XXX+	5.488	5.600	5.712						
ACE302X570XXX+	5.586	5.700	5.814						
ACE302X580XXX+	5.684	5.800	5.916						
ACE302X590XXX+	5.782	5.900	6.018						
ACE302X600XXX+	5.880	6.000	6.120						

Output Current1			Output Current2				Minimum Operating Voltage		Detector Threshold Temperature Coefficient		
Iout1[mA]			Iout2[mA]				VDDL[V]		-VDET/ Tppm/°C		
Condition	Min.	Typ.	Condition		Min.	Typ.	Typ.	Max.	Condition	Typ.	
NCH, VDS=0.05V, VDD=0.7V	0.01	0.05	NCH, VDS=0.5V	VDD=0.85V	0.1	0.5	0.5	0.7	-40°C	T _{opt} 85°C	100
				VDD=1.0V	0.2	1.0					
				VDD=1.5V	1.0	2.0					

Electrical Characteristics By Output Delay Time

Part Number	Test Condition	Output Delay Time			Unit
		Min	Typ	Max	
ACE302XXXXAXX+	V _{DD} =1.0V to V _{det} +1.0V	45	50	55	ms
ACE302XXXXBXX+		90	100	110	
ACE302XXXXCXX+		135	150	165	
ACE302XXXXDXX+		180	200	220	
ACE302XXXXEXX+		225	250	275	
ACE302XXXXFXX+		270	300	330	
ACE302XXXXGXX+		360	400	440	

Function description

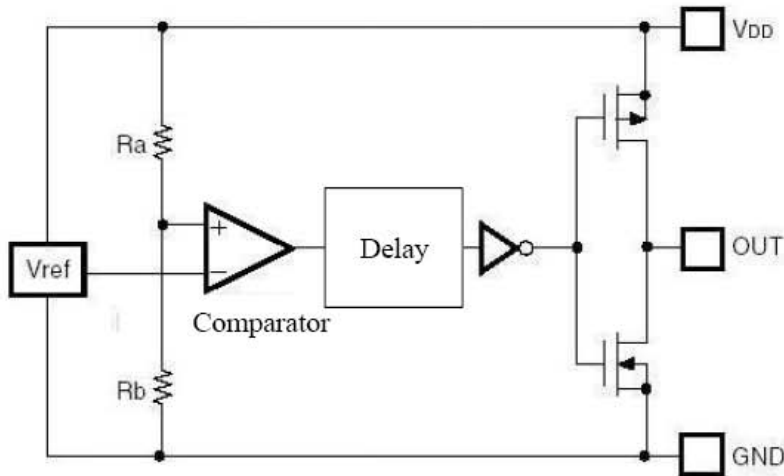

High precision low temperature co-efficiency reference voltage is applied to the negative input of a comparator. Input voltage, divided by resistor array of Ra and Rb, is applied to the positive input of the comparator. Output of the comparator passes a delay circuit and a series of buffer to drive the output CMOS pair.

$$V_{DET} = V_{REF} * (1 + R_a/R_b)$$

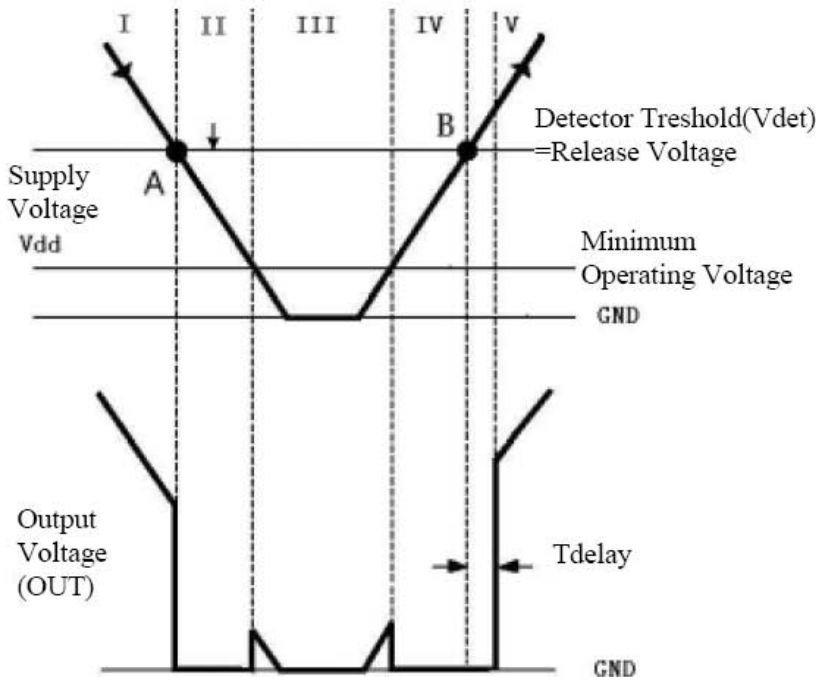

No	Operation status	Output status
I	$V_{DD} > V_{det}$	Output voltage is equal to the supply voltage
II	V_{DD} drops below V_{det}	Output voltage equals to GND level
III	V_{DD} drops further below V_{DDL}	Output voltage is undefined
IV	V_{DD} rises above V_{DDL}	Output voltage equals to GND level
V	V_{DD} rises above V_{det}	Output voltage equals to supply voltage after T_{delay}

Typical Circuits

(1) Supply current test circuit

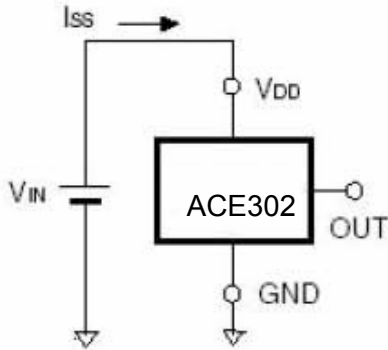

(2) Detector threshold test circuit

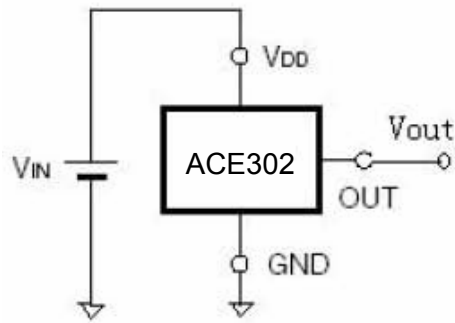

(3) NCHply current test circuit

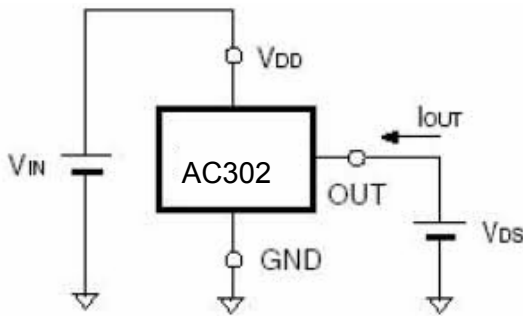

(2) Detector threshold test circuit

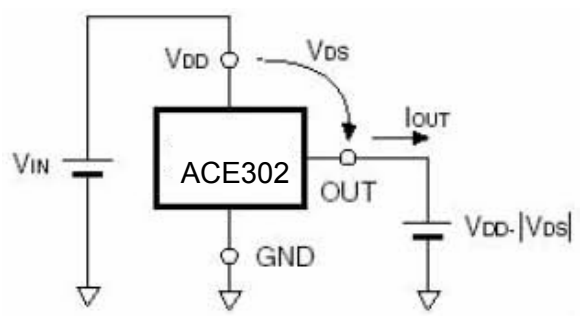

Typical Performance Characteristics

1. Supply current VS. Input Voltage

Detector threshold=0.9V

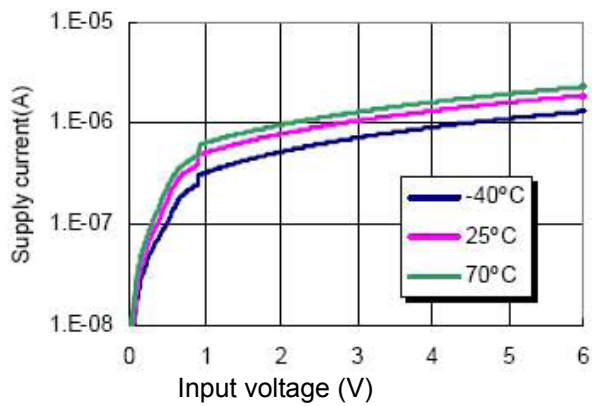

Detector threshold=2.7V

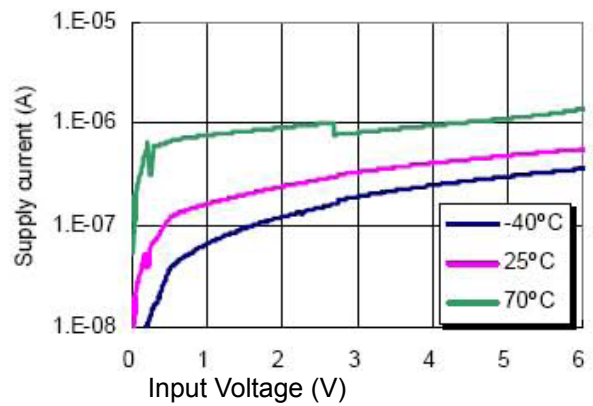

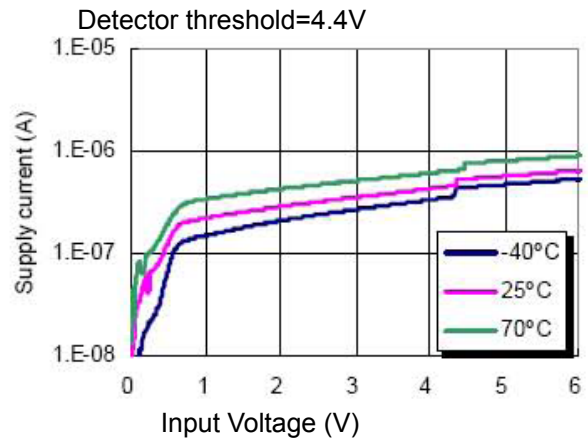
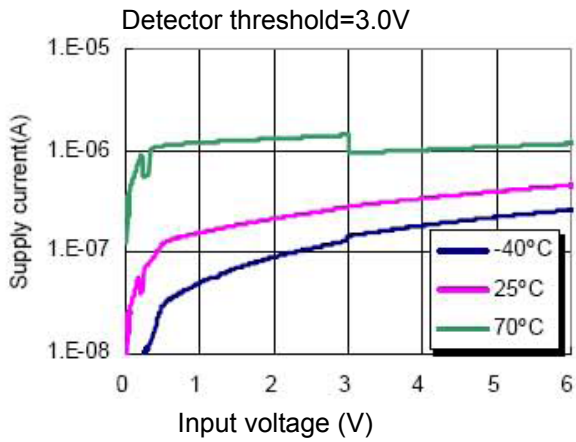

2. Detector Threshold VS. Temperature

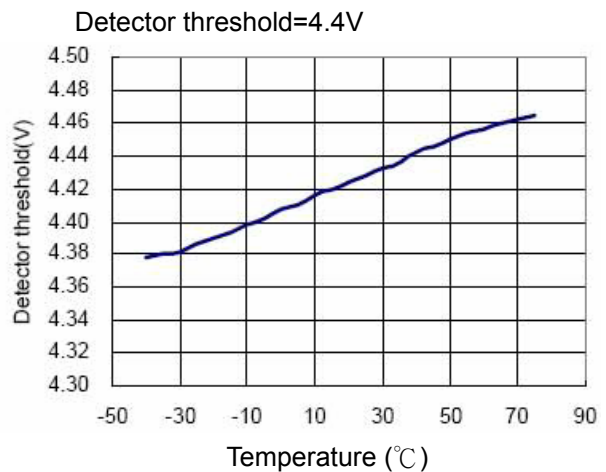
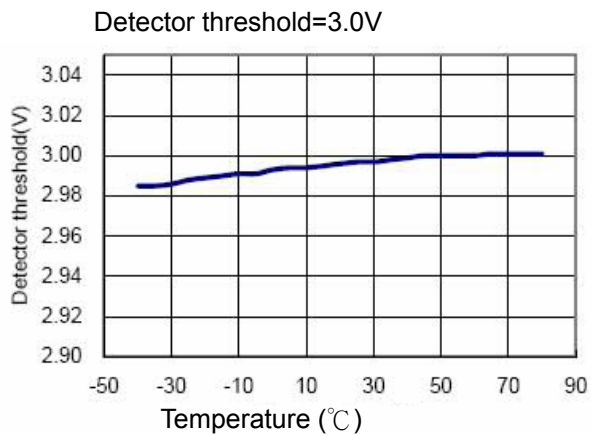
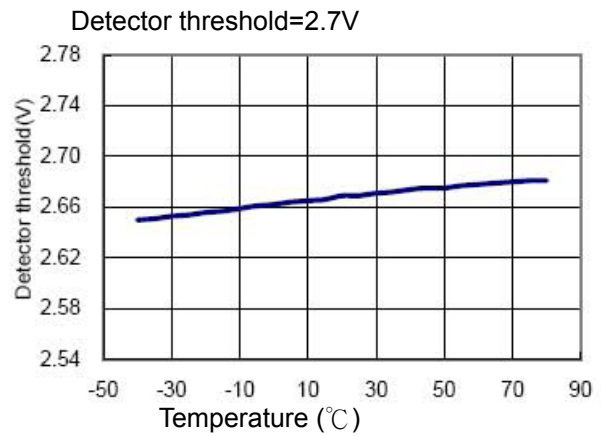
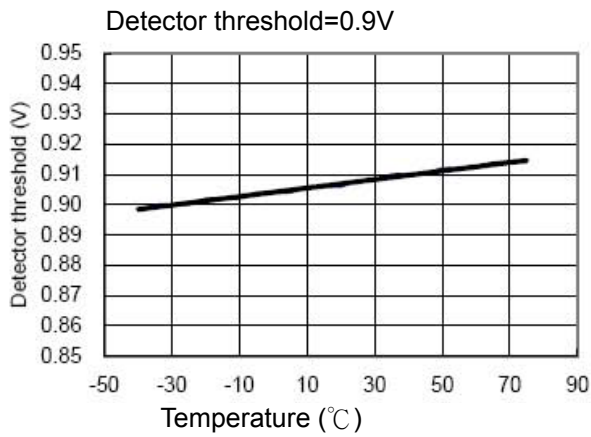

3. Nch Driver Output Current VS. Vds

ACE302X090XXX+

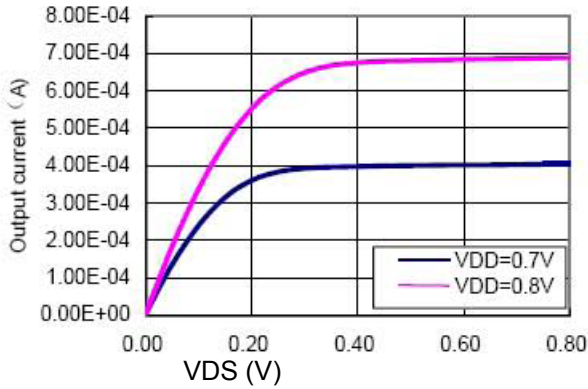

ACE302X270XXX+

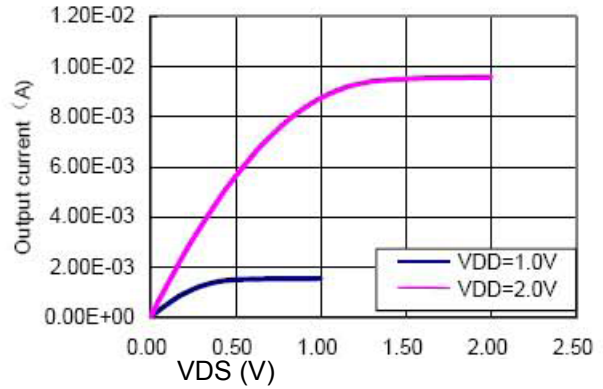

ACE302X300XXX+

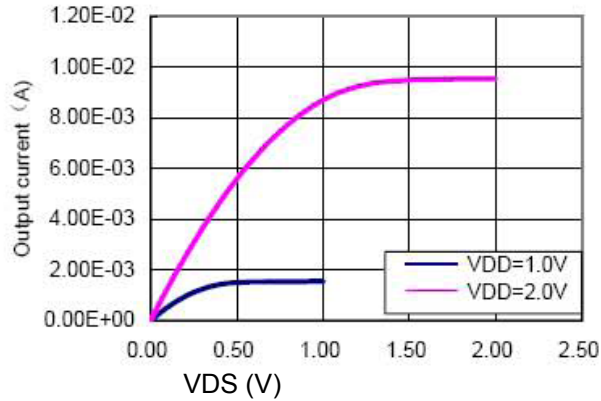

ACE302X440XXX+

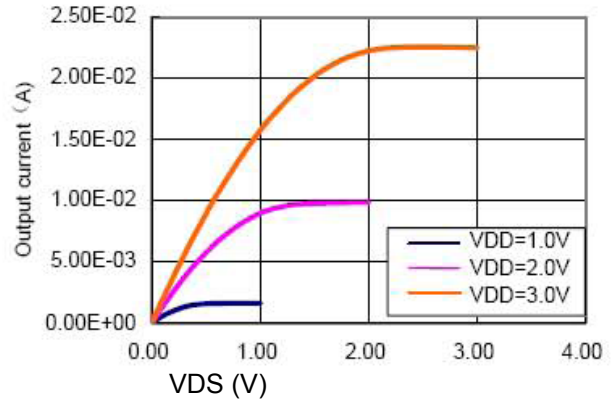

4. Nch Driver Output Current VS. Input Voltage

Detector threshold=2.7V

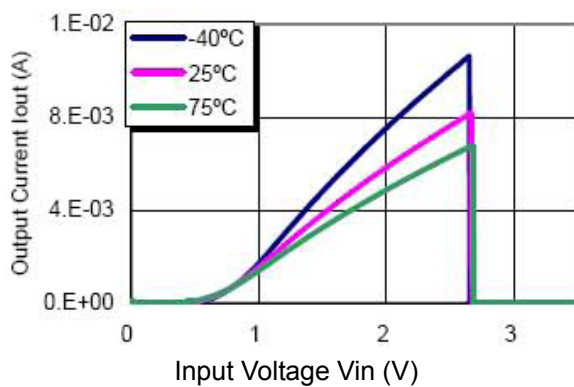

Detector threshold=3.0V

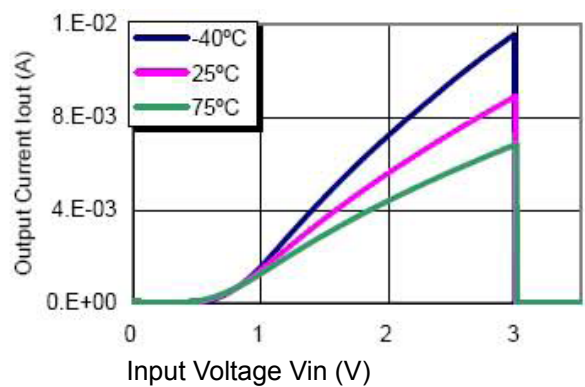

5. PCH Driver Output Current VS. Input Current

Detector threshold=0.9V

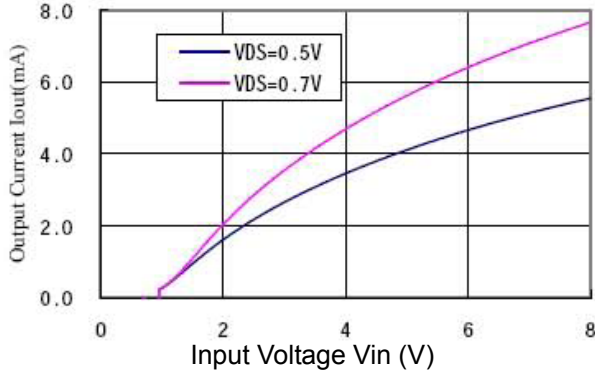

Detector threshold=2.7V

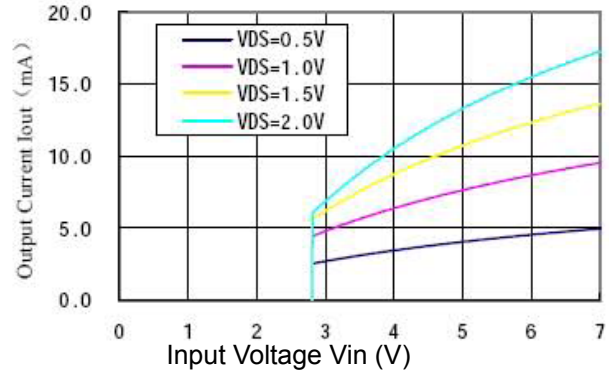

Detector threshold=4.4V

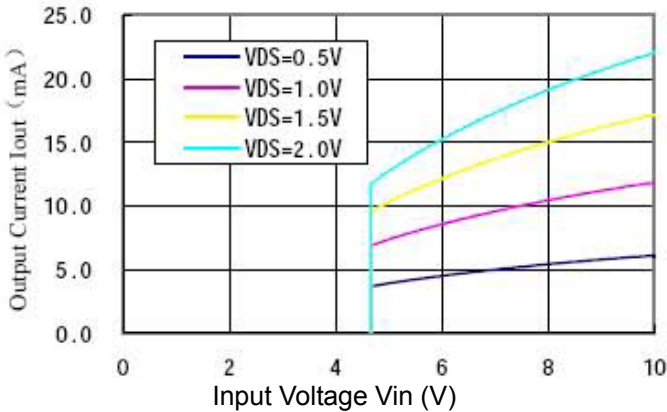

Typical Applications

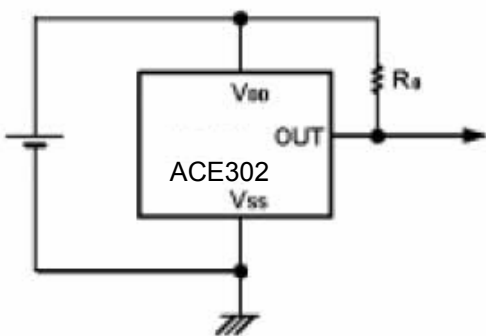

Note:

1. R0 is unnecessary for CMOS output products.
2. The value of R0 need to be selected in different application, Typical value is 470kΩ

Packing Information

SOT-23-3

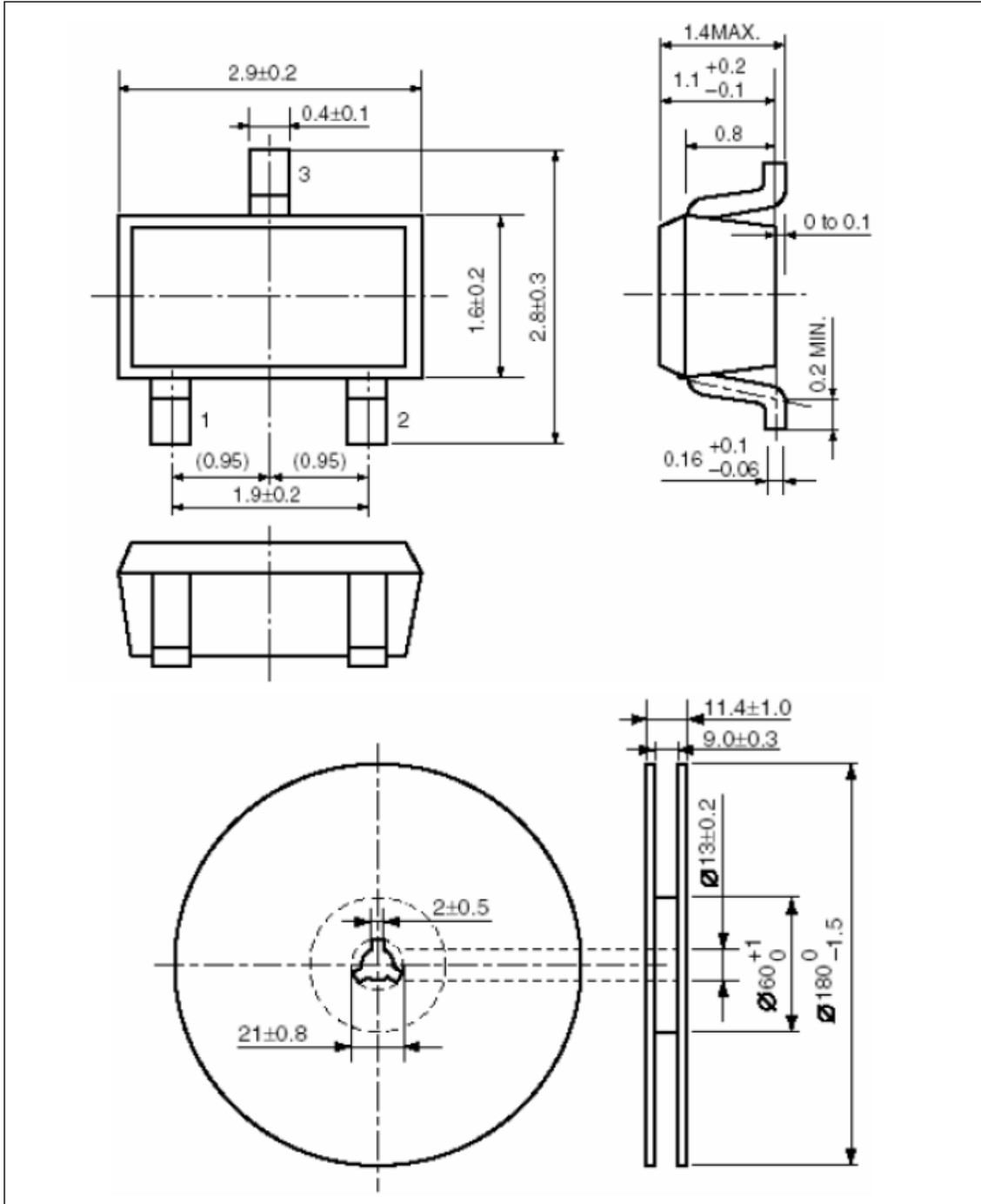

Notes

ACE does not assume any responsibility for use as critical components in life support devices or systems without the express written approval of the president and general counsel of ACE Electronics Co., LTD. As sued herein:

1. Life support devices or systems are devices or systems which, (a) are intended for surgical implant into the body, or (b) support or sustain life, and whose failure to perform when properly used in accordance with instructions for use provided in the labeling, can be reasonably expected to result in a significant injury to the user.
2. A critical component is any component of a life support device or system whose failure to perform can be reasonably expected to cause the failure of the life support device or system, or to affect its safety or effectiveness.

ACE Technology Co., LTD.
<http://www.ace-ele.com/>