

SOT-23 Plastic-Encapsulate Transistors

BC856 TRANSISTOR (PNP)

BC857

BC858

FEATURES

- Ideally suited for automatic insertion
- For Switching and AF Amplifier Applications

SOT-23

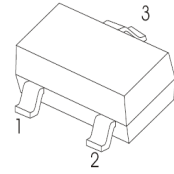

1. BASE
2. EMITTER
3. COLLECTOR

MAXIMUM RATINGS (T_a=25°C unless otherwise noted)

Symbol	Parameter	Value	Unit
V _{CBO}	Collector-Base Voltage		
	BC856	-80	V
	BC857	-50	
	BC858	-30	
V _{CEO}	Collector-Emitter Voltage		
	BC856	-65	V
	BC857	-45	
	BC858	-30	
V _{EBO}	Emitter-Base Voltage	-5	V
I _C	Collector Current –Continuous	-0.1	A
P _C	Collector Power Dissipation	200	mW
R _{θJA}	Thermal Resistance From Junction To Ambient	625	°C/W
T _J	Junction Temperature	150	°C
T _{stg}	Storage Temperature	-65~+150	°C

DEVICE MARKING

BC856A=3A;BC856B=3B;
 BC857A=3E;BC857B=3F;BC857C=3G;
 BC858A=3J; BC858B=3K; BC858C=3L

ELECTRICAL CHARACTERISTICS (T_a=25°C unless otherwise specified)

Parameter	Symbol	Test conditions	Min	Max	Unit
Collector-base breakdown voltage BC856 BC857 BC858	V _{CBO}	I _C = -10μA, I _E =0	-80 -50 -30		V
Collector-emitter breakdown voltage BC856 BC857 BC858	V _{CEO}	I _C = -10mA, I _B =0	-65 -45 -30		V
Emitter-base breakdown voltage	V _{EBO}	I _E = -1μA, I _C =0	-5		V
Collector cut-off current BC856 BC857 BC858	I _{CBO}	V _{CB} = -70 V, I _E =0 V _{CB} = -45 V, I _E =0 V _{CB} = -25 V, I _E =0		-0.1	μA
Collector cut-off current BC856 BC857 BC858	I _{CEO}	V _{CE} = -60 V, I _B =0 V _{CE} = -40 V, I _B =0 V _{CE} = -25 V, I _B =0		-0.1	μA
Emitter cut-off current	I _{EBO}	V _{EB} = -5 V, I _C =0		-0.1	μA
DC current gain BC856A, 857A,858A BC856B, 857B,858B BC857C,BC858C	h _{FE}	V _{CE} = -5V,I _C = -2mA	125 220 420	250 475 800	
Collector-emitter saturation voltage	V _{CE(sat)}	I _C =-100mA,I _B = -5 mA		-0.5	V
Base-emitter saturation voltage	V _{BE(sat)}	I _C = -100mA, I _B = -5mA		-1.1	V
Transition frequency	f _T	V _{CE} = -5 V, I _C = -10mA f=100MHz	100		MHz
Collector capacitance	C _{ob}	V _{CB} =-10V, f=1MHz		4.5	pF

Typical Characteristics

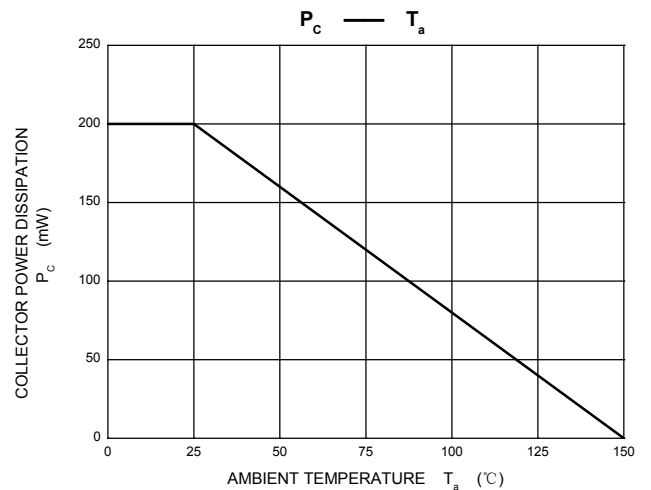
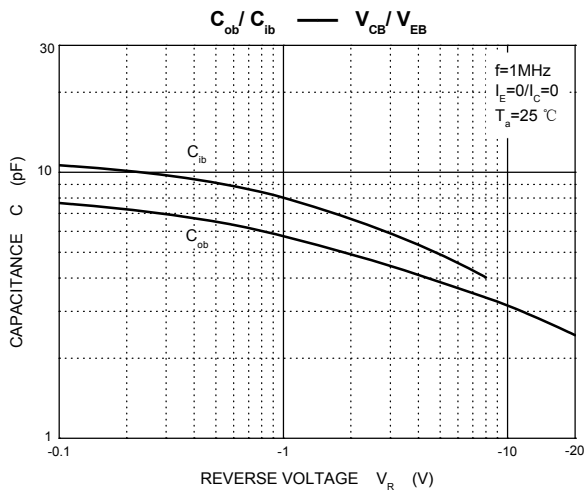
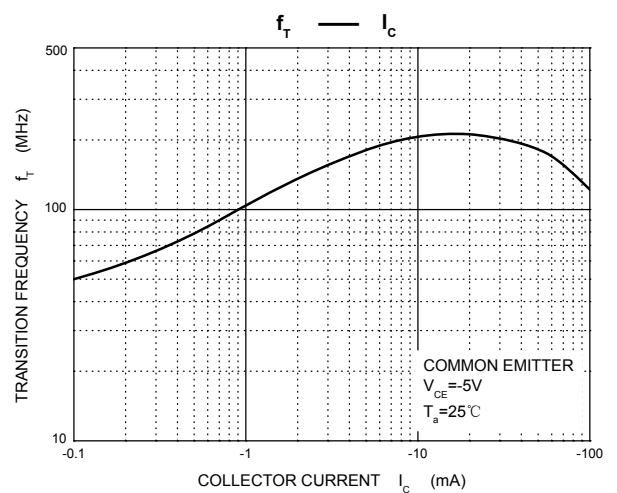
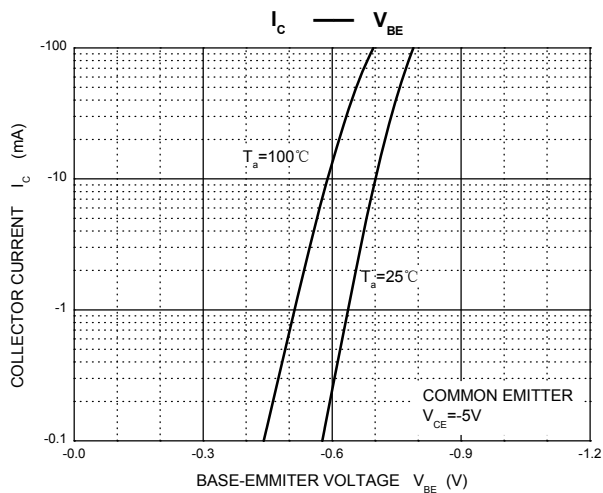
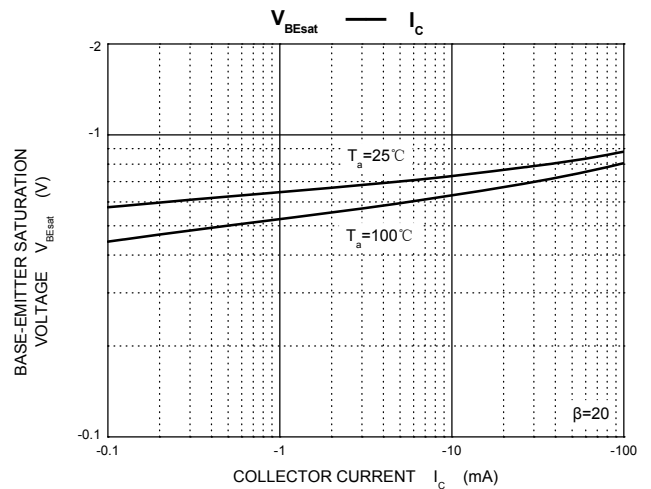
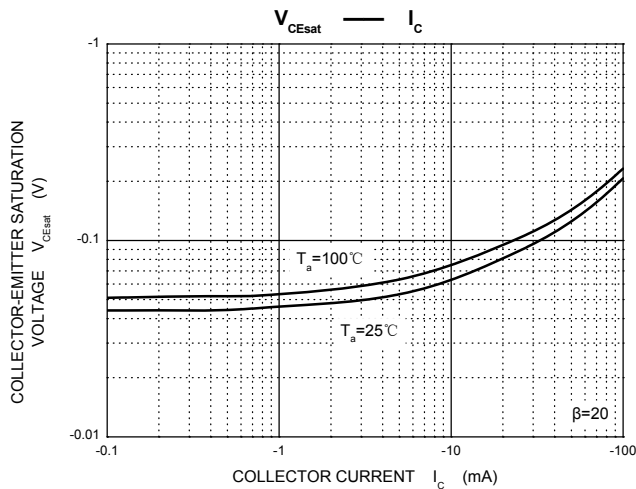
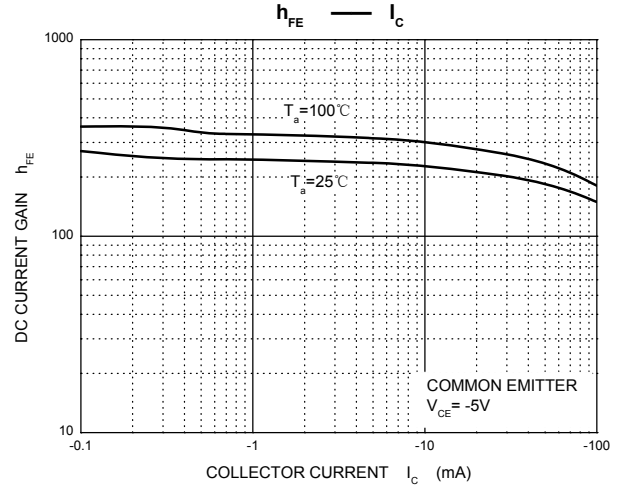
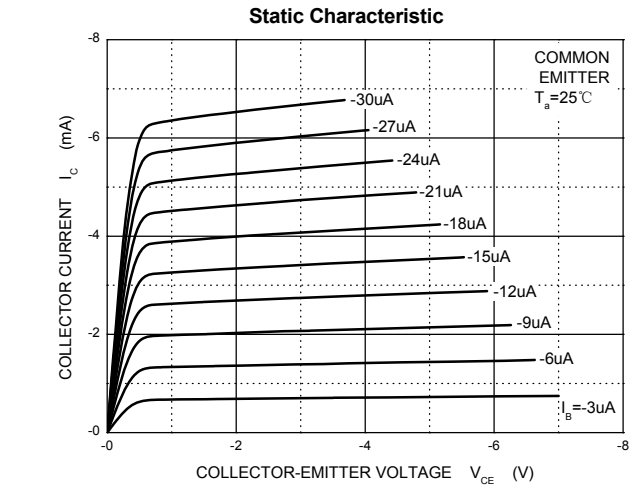

SOT-23 Package Outline Dimensions



Symbol	Dimensions In Millimeters		Dimensions In Inches	
	Min	Max	Min	Max
A	0.900	1.150	0.035	0.045
A1	0.000	0.100	0.000	0.004
A2	0.900	1.050	0.035	0.041
b	0.300	0.500	0.012	0.020
c	0.080	0.150	0.003	0.006
D	2.800	3.000	0.110	0.118
E	1.200	1.400	0.047	0.055
E1	2.250	2.550	0.089	0.100
e	0.950 TYP		0.037 TYP	
e1	1.800	2.000	0.071	0.079
L	0.550 REF		0.022 REF	
L1	0.300	0.500	0.012	0.020
θ	0°	8°	0°	8°

SOT-23 Suggested Pad Layout



- Note:
1. Controlling dimension: in millimeters.
 2. General tolerance: $\pm 0.05\text{mm}$.
 3. The pad layout is for reference purposes only.

NOTICE

JCET reserve the right to make modifications, enhancements, improvements, corrections or other changes without further notice to any product herein. JCET does not assume any liability arising out of the application or use of any product described herein.

SOT-23 Tape and Reel

SOT-23 Embossed Carrier Tape



Packaging Description:

SOT-23 parts are shipped in tape. The carrier tape is made from a dissipative (carbon filled) polycarbonate resin. The cover tape is a multilayer film (Heat Activated Adhesive in nature) primarily composed of polyester film, adhesive layer, sealant, and anti-static sprayed agent. These reeled parts in standard option are shipped with 3,000 units per 7" or 17.8cm diameter reel. The reels are clear in color and is made of polystyrene plastic (anti-static coated).

Dimensions are in millimeter

Pkg type	A	B	C	d	E	F	P0	P	P1	W
SOT-23	3.15	2.77	1.22	Ø1.50	1.75	3.50	4.00	4.00	2.00	8.00

SOT-23 Tape Leader and Trailer

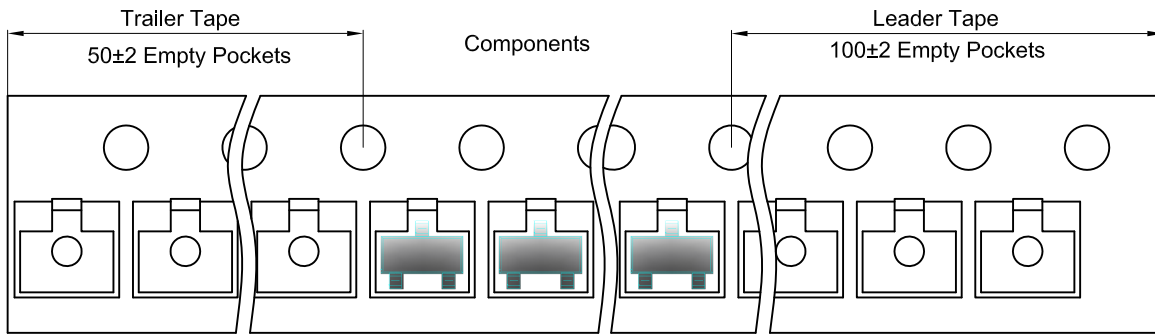

SOT-23 Reel

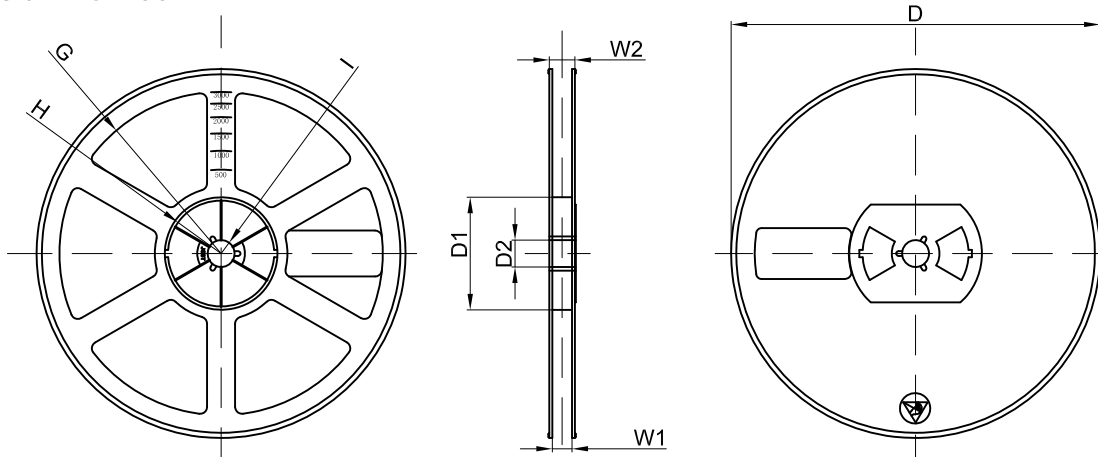

Dimensions are in millimeter

Reel Option	D	D1	D2	G	H	I	W1	W2
7"Dia	Ø178.00	54.40	13.00	R78.00	R25.60	R6.50	9.50	12.30

REEL	Reel Size	Box	Box Size(mm)	Carton	Carton Size(mm)	G.W.(kg)
3000 pcs	7 inch	45,000 pcs	203×203×195	180,000 pcs	438×438×220	