



SURFACE MOUNT PHEMT 1 WATT POWER AMPLIFIER, 12 - 16 GHz

Typical Applications

The HMC489LP5 / HMC489LP5E is ideal for use as a power amplifier for:

- Point-to-Point Radios
- Point-to-Multi-Point Radios
- Test Equipment and Sensors
- Military End-Use

Features

- Saturated Power: +32 dBm @ 16% PAE
- Output IP3: +34 dBm
- Gain: 13 dB
- +7V @ 1300 mA Supply
- 50 Ohm Matched Input/Output
- 25 mm² Leadless SMT Package

Functional Diagram

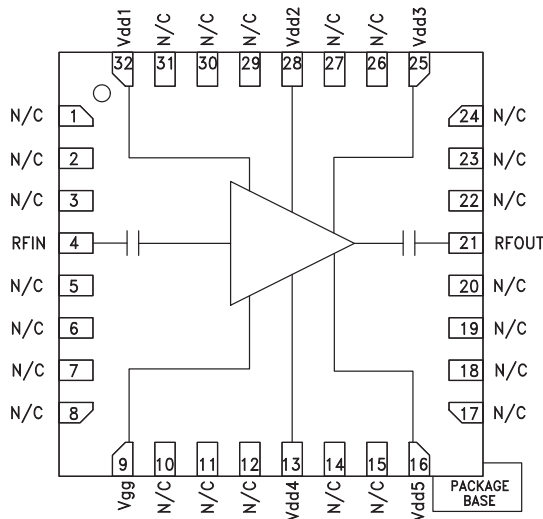

General Description

The HMC489LP5 & HMC489LP5E are high dynamic range GaAs PHEMT MMIC Power Amplifiers housed in leadless 5 x 5 mm surface mount packages. Operating from 12 to 16 GHz, the amplifier provides 13 dB of gain, +32 dBm of saturated power and 16% PAE from a +7V supply voltage. Output IP3 is +34 dBm typical. The RF I/Os are DC blocked and matched to 50 Ohms for ease of use. The HMC489LP5(E) eliminate the need for wire bonding, allowing use of surface mount manufacturing techniques.

Electrical Specifications, $T_A = +25^\circ C$, $V_{dd1, 2, 3, 4, 5} = +7V$, $I_{dd} = 1300 mA^*$

Parameter	Min.	Typ.	Max.	Min.	Typ.	Max.	Units
Frequency Range	12 - 14		14 - 16				GHz
Gain	10	13		10	13		dB
Gain Variation Over Temperature		0.05	0.07		0.05	0.07	dB/°C
Input Return Loss		12			8		dB
Output Return Loss		8			15		dB
Output Power for 1 dB Compression (P1dB)	24	29		28	31		dBm
Saturated Output Power (Psat)		30			32		dBm
Output Third Order Intercept (IP3)		32			34		dBm
Noise Figure		7			9		dB
Supply Current (I _{dd})(V _{dd} = +7V, V _{gg} = -0.3V Typ.)		1300			1300		mA

* Adjust V_{gg} between -2 to 0V to achieve I_{dd} = 1300 mA typical.



**SURFACE MOUNT PHEMT 1 WATT
POWER AMPLIFIER, 12 - 16 GHz**

Broadband Gain and Return Loss

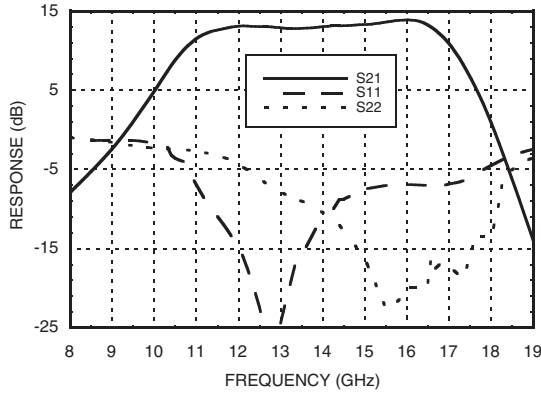

Gain vs. Temperature

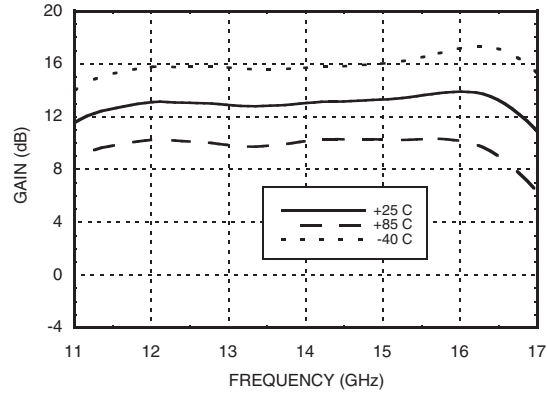

Input Return Loss vs. Temperature

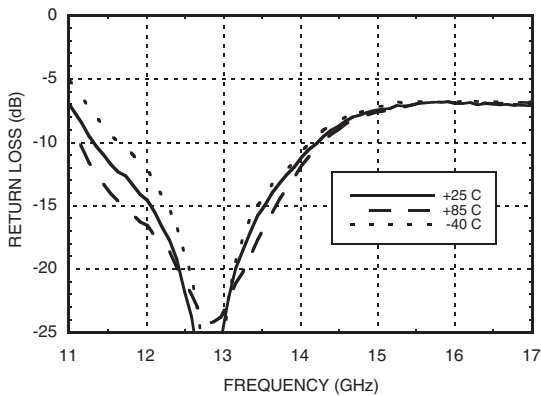

Output Return Loss vs. Temperature

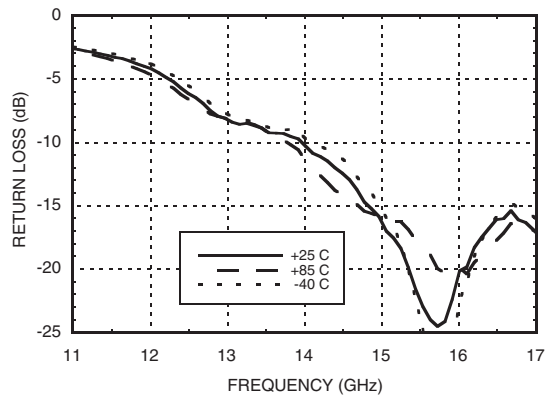

P1dB vs. Temperature

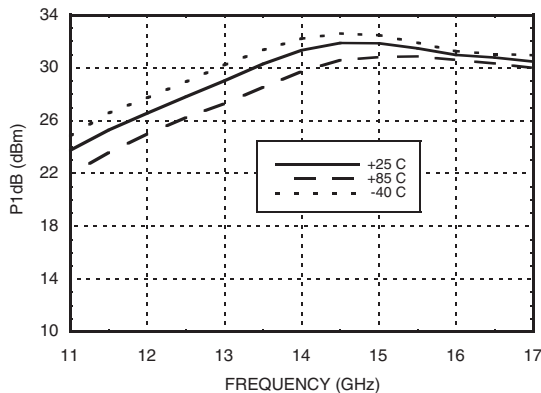

Psat vs. Temperature

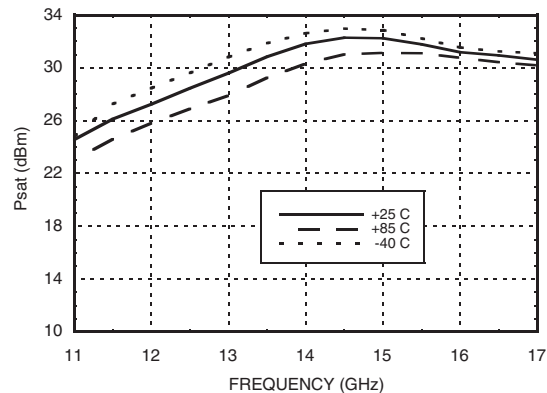

Output IP3 vs. Temperature

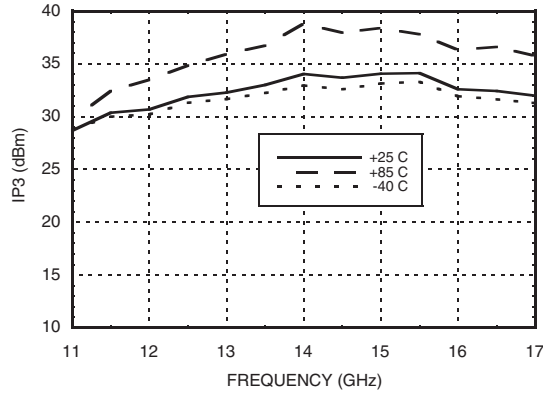

Power Compression @ 15 GHz

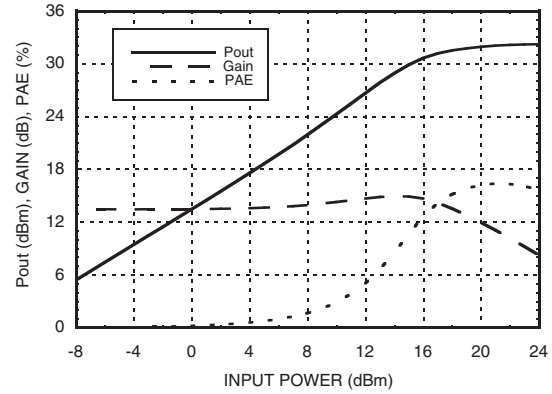

**Gain, Power & Output IP3
vs. Supply Voltage @ 15 GHz**

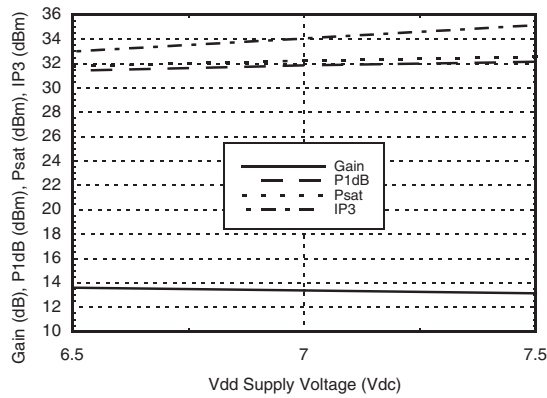

**Gain, Power & OIP3
vs. Supply Current @ 15 GHz**

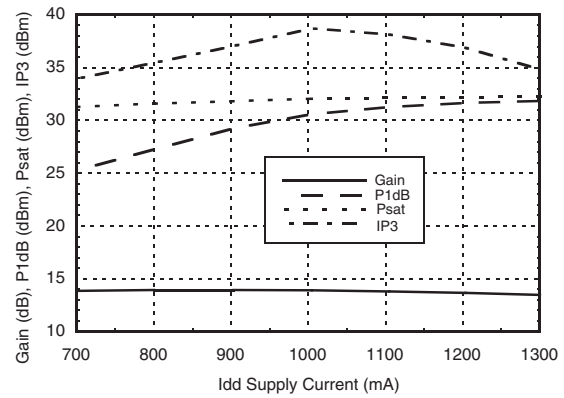

Noise Figure vs. Temperature

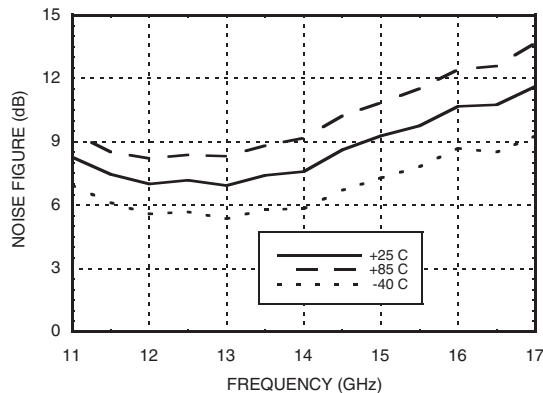

Reverse Isolation vs. Temperature

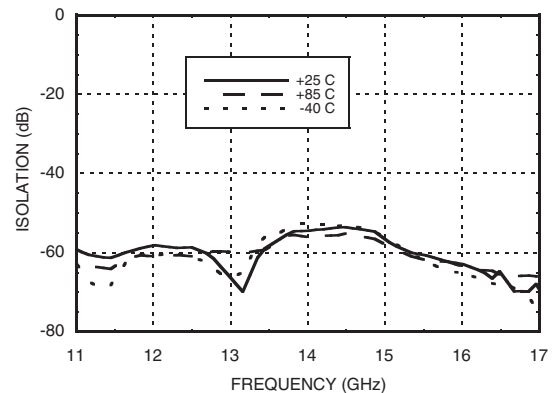

SURFACE MOUNT PHEMT 1 WATT POWER AMPLIFIER, 12 - 16 GHz

Power Dissipation*

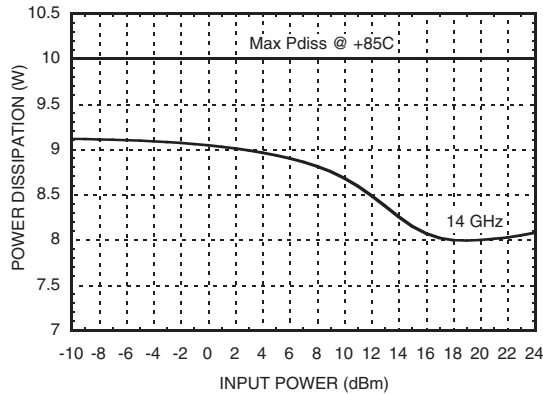

* Refer to "Thermal Management for Surface Mount Components" application note herein.



**ELECTROSTATIC SENSITIVE DEVICE
OBSERVE HANDLING PRECAUTIONS**

Typical Supply Current vs. Vdd

Vdd (Vdc)	Idd (mA)
+6.5	1330
+7.0	1300
+7.5	1285

Note: Amplifier will operate over full voltage ranges shown above. Vgg adjusted to achieve Idd= 1300 mA at +7.0V.

Absolute Maximum Ratings

Drain Bias Voltage (Vdd1, 2, 3, 4, 5)	+8 Vdc
Gate Bias Voltage (Vgg)	-2.0 to 0 Vdc
RF Input Power (RFIN)(Vdd = +7.0 Vdc)	+28 dBm
Channel Temperature	150 °C
Continuous Pdiss (T= 85 °C) (derate 154 mW/°C above 85 °C)	10 W
Thermal Resistance (channel to ground paddle)	6.5 °C/W
Storage Temperature	-65 to +150 °C
Operating Temperature	-40 to +85 °C

Outline Drawing

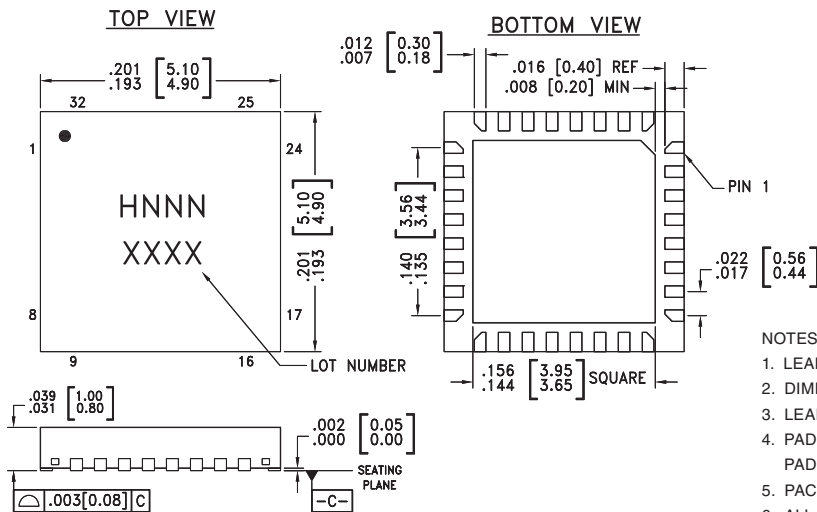

NOTES:

- LEADFRAME MATERIAL: COPPER ALLOY
- DIMENSIONS ARE IN INCHES [MILLIMETERS]
- LEAD SPACING TOLERANCE IS NON-CUMULATIVE.
- PAD BURR LENGTH SHALL BE 0.15mm MAXIMUM. PAD BURR HEIGHT SHALL BE 0.05mm MAXIMUM.
- PACKAGE WARP SHALL NOT EXCEED 0.05mm.
- ALL GROUND LEADS AND GROUND PADDLE MUST BE SOLDERED TO PCB RF GROUND.
- REFER TO HITTITE APPLICATION NOTE FOR SUGGESTED LAND PATTERN.

Package Information

Part Number	Package Body Material	Lead Finish	MSL Rating	Package Marking ^[3]
HMC489LP5	Low Stress Injection Molded Plastic	Sn/Pb Solder	MSL1 ^[1]	H489 XXXX
HMC489LP5E	RoHS-compliant Low Stress Injection Molded Plastic	100% matte Sn	MSL1 ^[2]	H489 XXXX

[1] Max peak reflow temperature of 235 °C

[2] Max peak reflow temperature of 260 °C

[3] 4-Digit lot number XXXX

Pin Descriptions

Pin Number	Function	Description	Interface Schematic
1 - 3, 5 - 8, 10 - 12, 14, 15, 17 - 20, 22 - 24, 26, 27, 29 - 31	N/C	No connection required. These pins may be connected to RF/DC ground without affecting performance.	
4	RFIN	This pin is AC coupled and matched to 50 Ohms.	RFIN ○ — —
9	Vgg	Gate control for amplifier. Adjust to achieve I _{dd} of 1300 mA. Please follow "MMIC Amplifier Biasing Procedure" Application Note. External bypass capacitors of 100 pF and 2.2 μF are required.	
21	RFOUT	This pin is AC coupled and matched to 50 Ohms.	— — ○ RFOUT
32, 28, 25, 13, 16	Vdd1, Vdd2, Vdd3, Vdd4, Vdd5	Power Supply Voltage for the amplifier. External bypass capacitors of 100 pF and 2.2 μF are required.	
	GND	Ground: Backside of package has exposed metal ground slug that must be connected to ground through a short path. Vias under the device are required	○ GND — —

Application Circuit

Component	Value
C1	100 pF
C2	2.2 μF

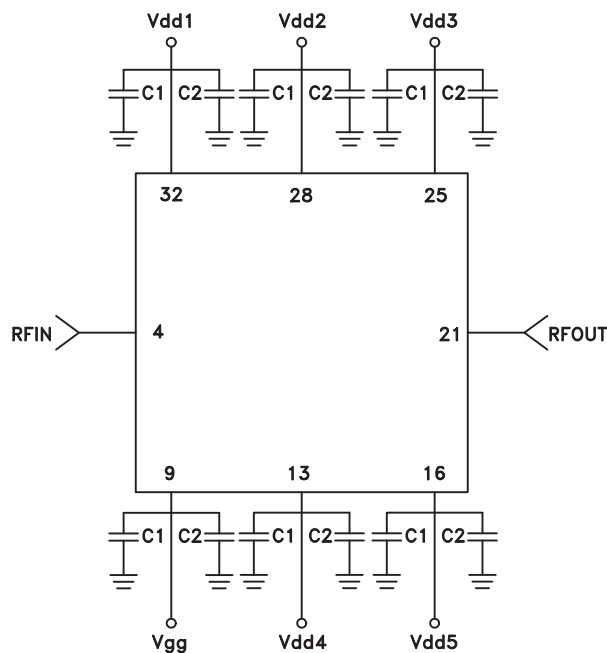

Evaluation PCB

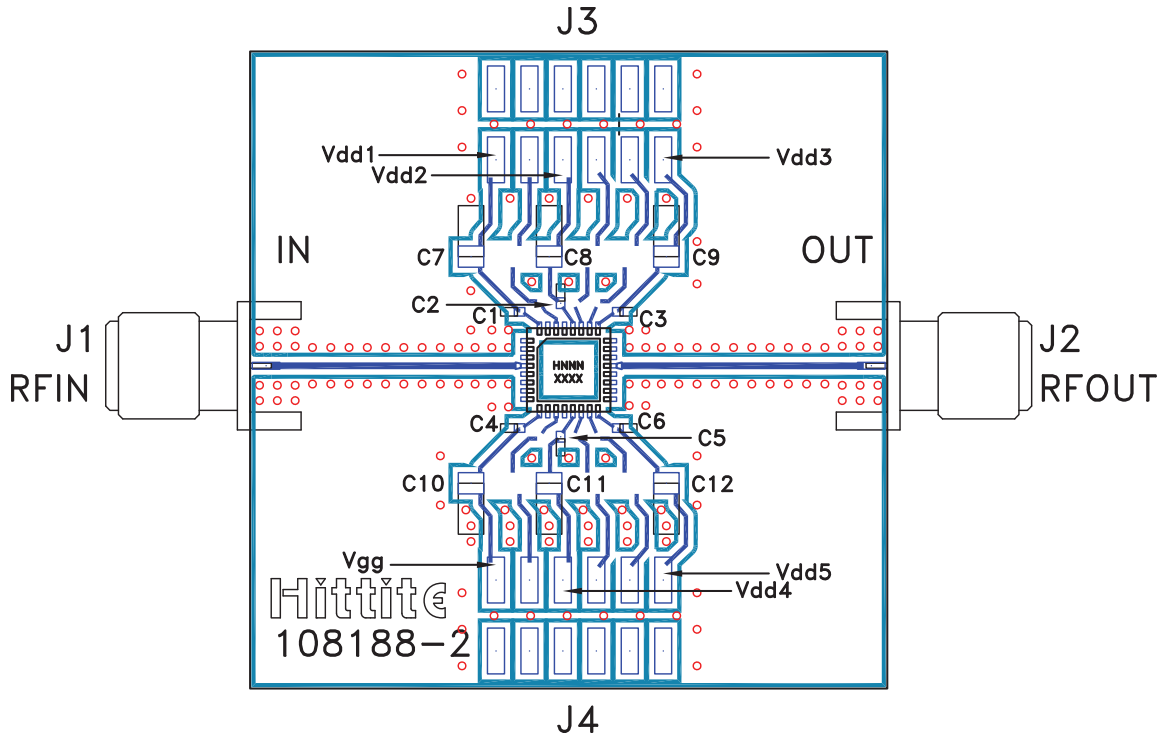

List of Materials for Evaluation PCB 108190 [1]

Item	Description
J1, J2	SRI PC Mount SMA Connector
J3, J4	2mm DC Header
C1 - C6	100 pF capacitor, 0402 pkg.
C7 - C12	2.2µF Capacitor, Tantalum
U1	HMC489LP5 / HMC489LP5E Amplifier
PCB [2]	108188 Evaluation PCB

[1] Reference this number when ordering complete evaluation PCB

[2] Circuit Board Material: Rogers 4350.

The circuit board used in this application should use RF circuit design techniques. Signal lines should have 50 ohm impedance while the package ground leads and exposed paddle should be connected directly to the ground plane similar to that shown. A sufficient number of via holes should be used to connect the top and bottom ground planes. Copper filled vias under the device are recommended. The evaluation board should be mounted to an appropriate heat sink. The evaluation circuit board shown is available from Hittite upon request.