

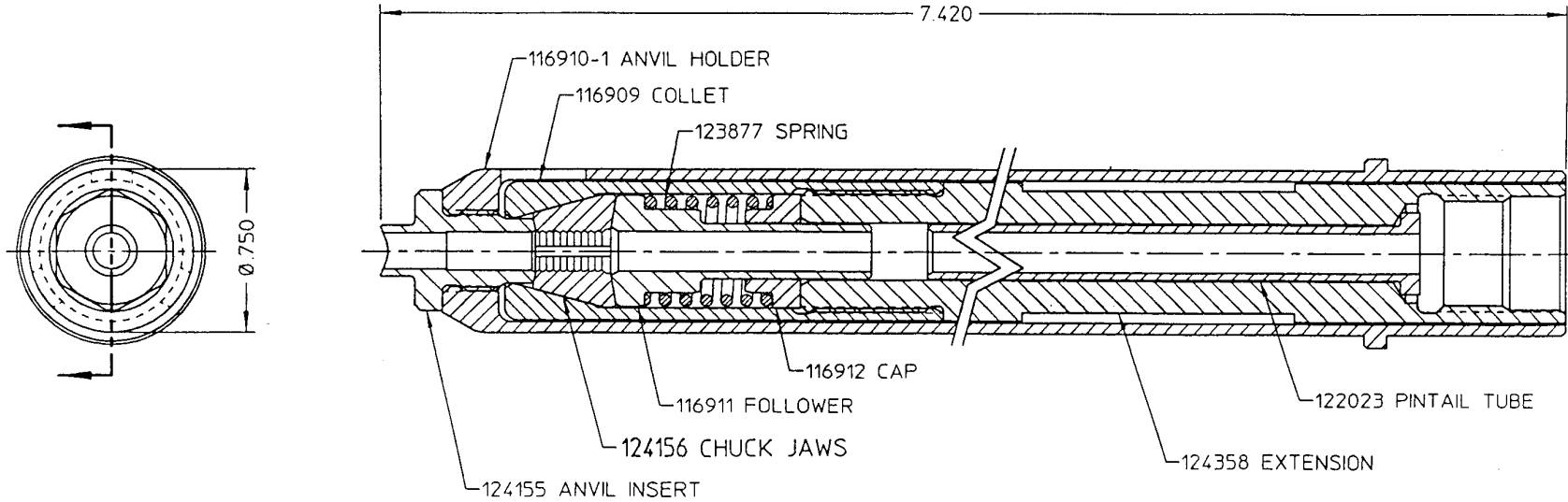

**Huck  
Fasteners**

From Cordant Technologies

# NOSE ASSEMBLY DATA SHEET



©Huck International, Inc. 1995  
©Registered Trademark of Huck International, Inc., Irvine, CA  
™Trademark of Huck International, Inc., Irvine, CA

<b>99-3463</b>	<b>Huck International, Inc.</b> Installation System Division 1 Corporate Drive - Kingston, NY 12401	
	<b>TYPE:</b> Blind Rivet <b>FOR:</b> SGR Peel-08; Long lgth. <b>TOOL:</b> 202; 212; 230; 2400	
	<b>OTHER</b>	<b>ISSUED:</b> 3-96 <b>REVISED:</b> 5-96 B

U.S. Patent No. 4,347,728

## Nose Assembly Maintenance

1. Prepare tool per manual - - remove any shims from spindle/rod with small pick. Select pintail tube below to prevent small diameter pintails from jamming in pull piston or spindle.

Fastener	200/212/230/2400
04 (1/8)	1005341
05 (5/32)	1005341
06 (3/16)	None req'd.

### WARNING

**Before maintenance or adjustments:**  
**POWERIG Hydraulic Unit must be disconnected from electrical or air supply; air operated tools must be disconnected from air supply. If not disconnected, severe personal injury may result.**

### 2. Tools that use hydraulic source :

Connect tool's hoses and controls to POWERIG Hydraulic Unit. Reconnect power source. Depress trigger for 30 seconds. Disconnect controls and RETURN hose. **Tool piston must be completely forward.**

### Tools using air source :

Air supply should have filter regulator lubricator unit with regulator set at 90 psi (620 kPa). See **WARNING** - - cycle tool a few times and disconnect **with spindle/rod completely forward.**

**Caution:** In severe conditions, VIBRATITE can be used on collet and/or extension threads to prevent loosening or damage. Carefully follow container's directions.

### 3. Disassembly/assembly as applicable :

Disassemble for inspection and maintenance.

**Collet/extension :** Assemble parts as shown.

Spread thin film of SUPER OLUBE on Orings and O D of follower. Tighten assembled collet onto extension using 9/16 collet wrench, wrench flats, 1/4 and/or 5/16 hex key. Tighten assembled collet onto extension to 28 32 ft. lbs - - see **Caution.**

**202/212/230/2400/2480 Tool :** Hold 3/16 hex key (202), 1/4 hex key (230) or 5/16 hex key (212/2400/2480) in hex at rear while tightening collet/extension to torque listed above.

**Anvil :** Thread anvil insert into anvil holder and torque 20 - 23 ft. lbs. for MG & MGL noses with anvil inserts - - others should be snugged-up securely. When changing insert, holder need not be removed. Pressed-in anvil is pressed out with drift and arbor press - - press new anvil in squarely to prevent cracking. Snug-up anvil spindle and/or install other parts as shown.

4. **Attaching to tool as applicable :** Slide holder/anvil over collet; stop and retaining nut over anvil/holder. Tighten adaptor to 28 32 ft. lbs. Install anvil holder and retaining sleeve - - tighten 3 screws to 3 5 ft. lbs.

5. **As applicable :** See **WARNING** - - connect controls and **RETURN** hose on hydraulic tool Reconnect hydraulic unit or air tool/unit to power source. Install fasteners in test plate of correct thickness with proper size - - inspect installed fasteners.

### Notes

1. **To extend jaw life :** Disassemble nose assembly periodically; clean and inspect components - - use a pick to clean jaw grooves. **Caution:** Wash parts in **mineral spirits or isopropyl alcohol** only. Dry Orings; urethane jaw assemblies **immediately** after cleaning as prolonged contact with solvent causes swelling - - dry other parts.

2. **Spare parts - - as required :** Jaws, Orings, anvil inserts, springs, screws, bearings,

3. **Tool/service items - - as required :** Brushes - NYLON bristle - 105805 (04, 05 & 06), 105806 (08); 9/16 collet wrench, 502914; drift, 83097 (.434 wide); 3/16 hex key, 502296; 1/4 hex key, 502445; 5/16 hex key, 502446; adjustable wrench, 503044; spanner wrench, 111239 (200); VIBRATITE, 505125; Parker SUPER OLUBE, 505476 (for Orings).