

Performance Parameters 2MC04-063-XXAN

Type	$\Delta T_{max}$ K	$Q_{max}$ W	$I_{max}$ A	$U_{max}$ V	AC R Ohm	H mm	h mm
2MC04-063-xx (N=16+47)							
2MC04-063-05AN	97	1.90	1.2	5.8	4.00	2.0	0.5
2MC04-063-08AN	97	1.23	0.8		6.40	2.6	0.8
2MC04-063-10AN	98	1.00	0.6		7.97	3.0	1.0
2MC04-063-12AN	98	0.83	0.5		9.55	3.4	1.2
2MC04-063-15AN	99	0.66	0.4		11.91	4.0	1.5

Performance data are given at 300K, vacuum

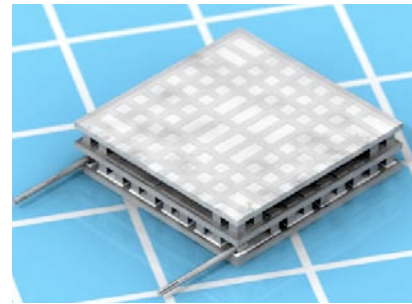

Technical Drawing

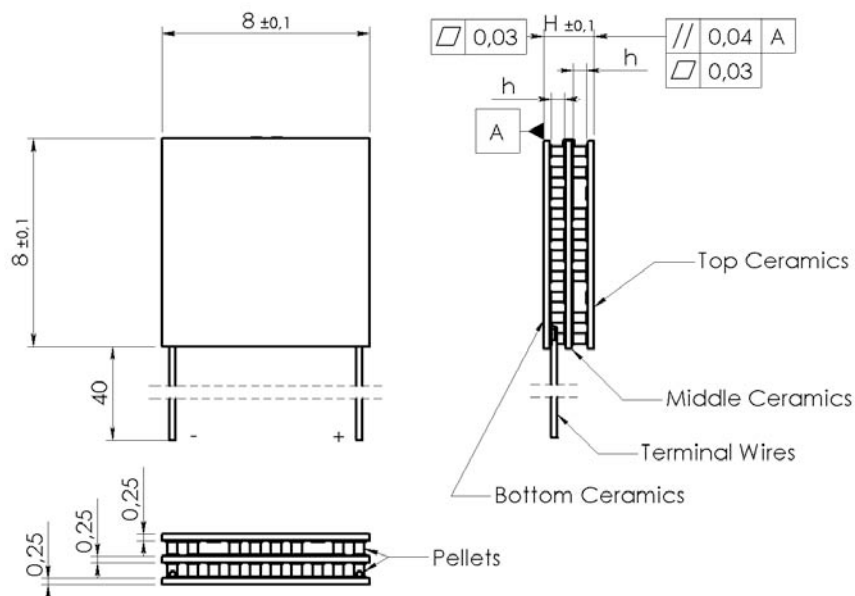

Options available

**A. TEC Assembly:**

Solder Sn-Sb (Tmelt=230°C)

**B. Ceramics:**

1. Pure Al<sub>2</sub>O<sub>3</sub>(100%)
2. Alumina (Al<sub>2</sub>O<sub>3</sub>- 96%)
3. Aluminum Nitride (AlN)

100% Al<sub>2</sub>O<sub>3</sub> used as standard

**C. Ceramics Surface Options**

1. Blank ceramics
2. Metallized:
  - 2.1 Ni / Sn(Bi)
  - 2.2 Gold plating
3. Metallized and pre-tinned:
  - 3.1 Solder 94 (Pb-Sn-Bi, Tmelt=94°C)
  - 3.2 Solder 117 (In-Sn, Tmelt=117°C)
  - 3.3 Solder 138 (Sn-Bi, Tmelt=138°C)
  - 3.4 Solder 183 (Pb-Sn, Tmelt=183°C)

**D. Thermistor (optional)**

Can be mounted to cold side ceramics edge. Calibration is available.

**E. Terminal wires**

1. Pre-tinned Copper
2. Insulated Wires
3. Insulated Color Coded

Performance Plots

2MC04-063-05AN

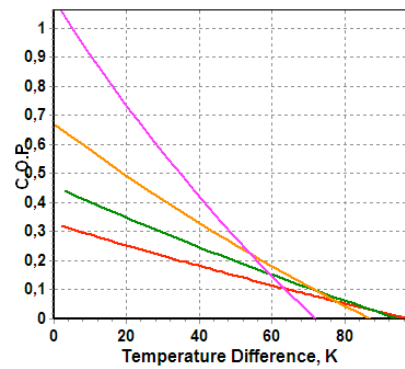
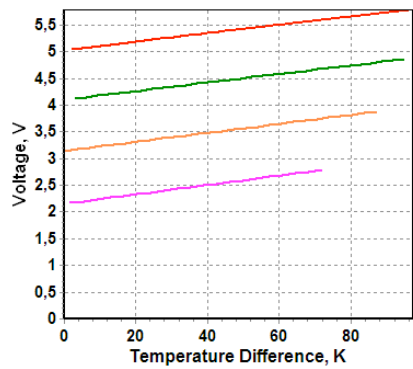
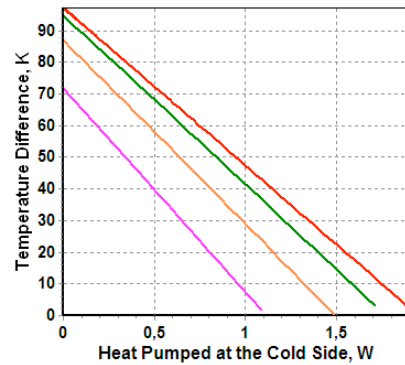
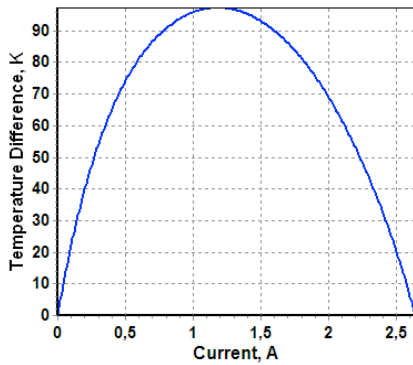

Performance Plots

2MC04-063-08AN

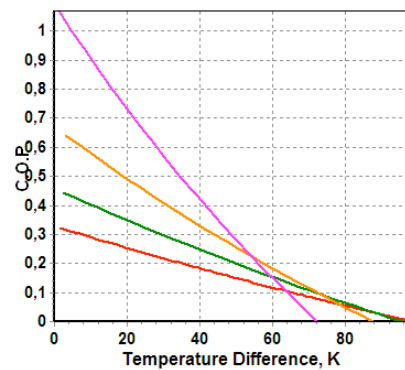
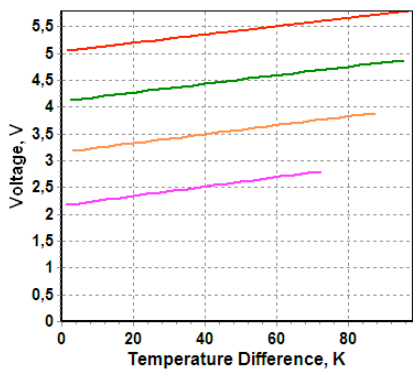
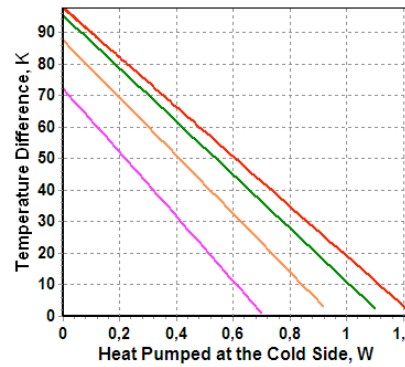
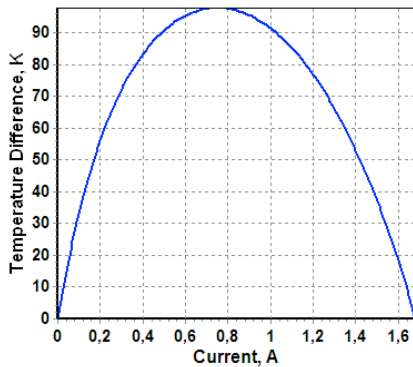

Color Legend: **Imax**, **0.8 Imax**, **0.6 Imax**, **0.4 Imax**

Performance Plots 2MC04-063-10AN

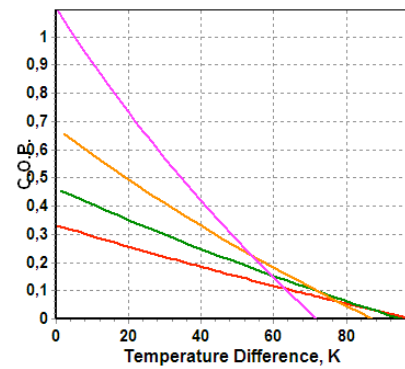
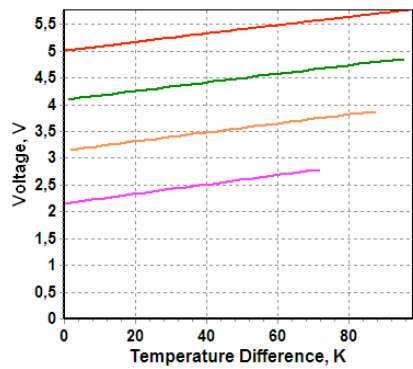
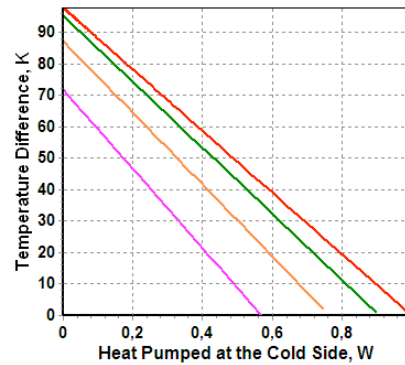
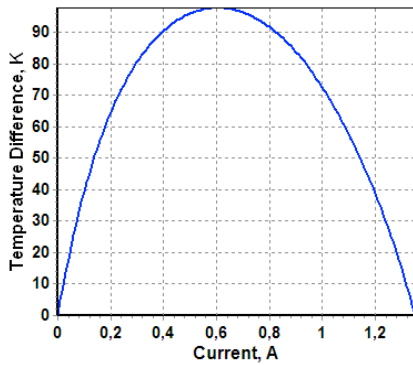

Performance Plots 2MC04-063-12AN

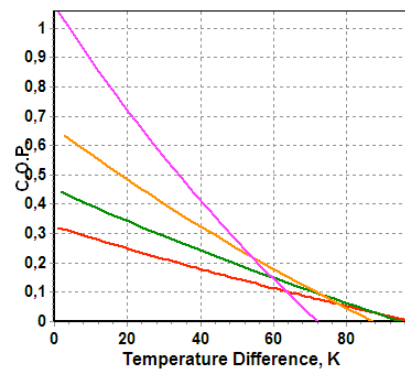
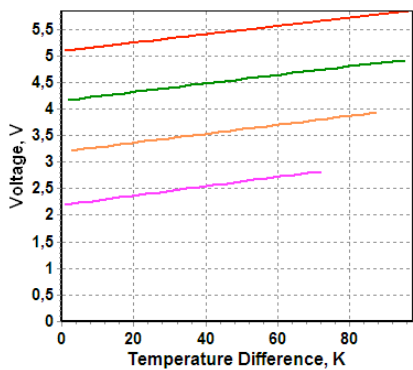
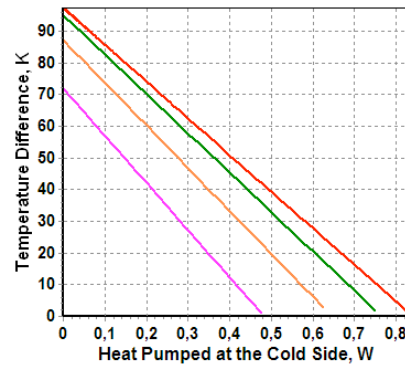
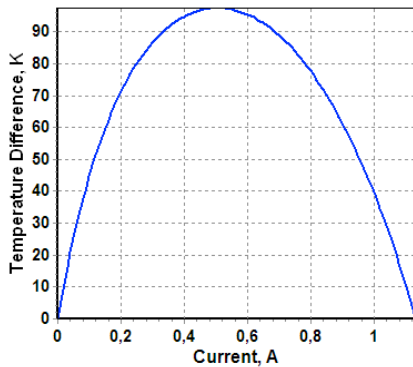

Color Legend: **I<sub>max</sub>**, **0.8 I<sub>max</sub>**, **0.6 I<sub>max</sub>**, **0.4 I<sub>max</sub>**

Performance Plots 2MC04-063-15AN

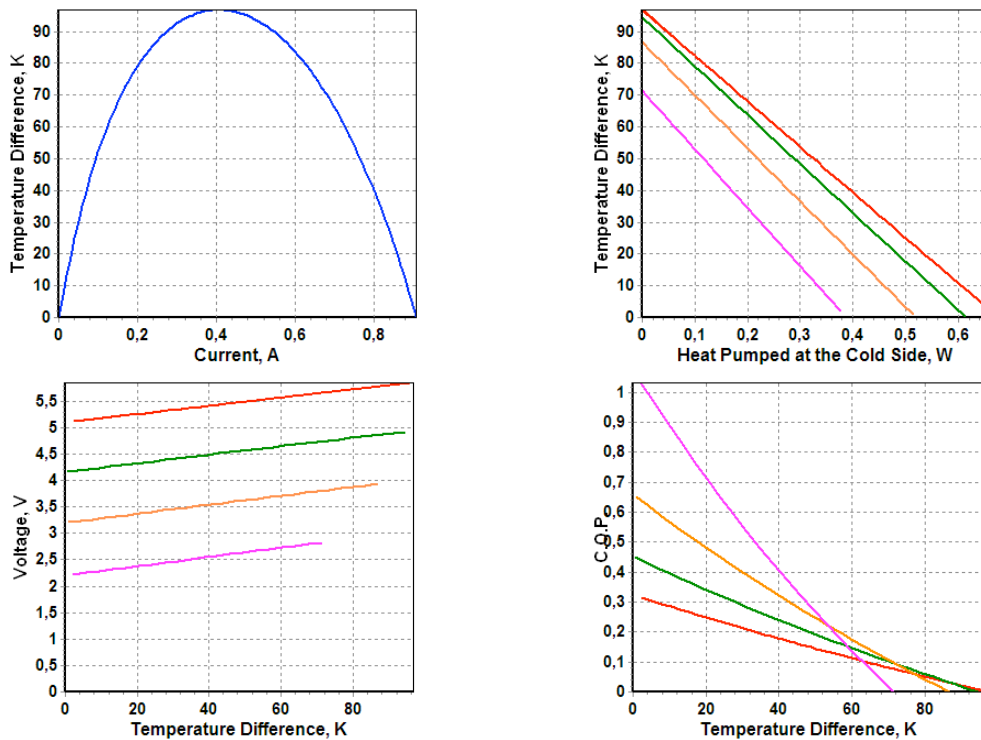

Color Legend: **I<sub>max</sub>**, **0.8 I<sub>max</sub>**, **0.6 I<sub>max</sub>**, **0.4 I<sub>max</sub>**

**Application Tips**

1. Never heat TE module more than 200°C (TEC assembled at 230°C).
2. Never use TE module without attached heat sink at hot (bottom) side.
3. Connect TE module to DC power supply according to polarity.
4. Do not apply DC current higher than I<sub>max</sub>.

**Installation**

1. **Mechanical Mounting.** TEC is placed between two heat exchangers. This construction is fixed by screws or in another mechanical way. It is suitable for large modules (with dimensions 30x30mm and larger). Miniature types require other assembling methods in most cases.
2. **Soldering.** This method is suitable for a TE module with metallized outside surfaces. RMT provides this option and also makes pre-tinning for TE modules.
3. **Glueing.** It is an up-to-date method that is used by many customers due to availability of glues with good thermoconductive properties. A glue is usually based on some epoxy compound filled with some thermoconductive material such as graphite or diamond powders, silver, SiN and others. The application of a specific type depends on application features and the type of a TE module.

