

1. Synopsis

1-1. Feature List

- For General Purpose Switching Applications
- Fast Switching Speed
- Totally Lead-Free & Fully RoHS Compliant
- Halogen and Antimony Free. "Green" Device
- High Breakdown Voltage
- Low Capacitance
- Low Leakage Current

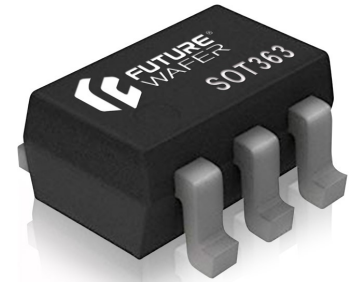

SOT363

1-2. Applications

- Ultra High-Speed Switching
- Voltage Clamping

1-3. Mechanical Characteristics

- Molded JEDEC Package: SOT363
- Packing: Tape and Reel
- Flammability Rating UL 94V-0
- Halogen Free
- JEDEC MSL Classification: Level 1

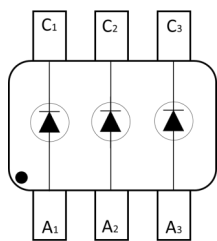

BAS40DW

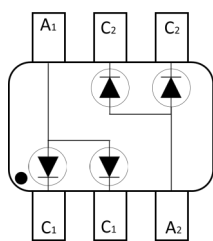

BAS40ADW

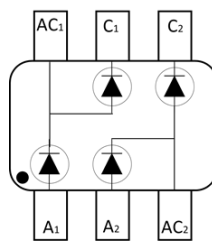

BAS40BDW

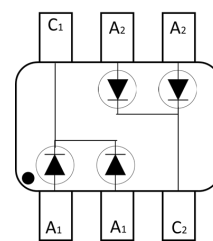

BAS40CDW

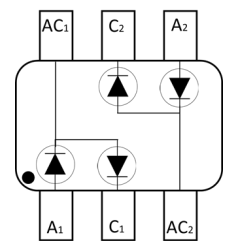

BAS40SDW

1-4. Absolute Maximum Ratings

Parameter	Symbol	Conditions	Values	Units
Peak Repetitive Reverse Voltage	V_{RRM}	$T_J = 25^\circ\text{C}$	40	V
Working Peak Reverse Voltage	V_{RWM}			
DC Reverse Voltage	V_R			
Non-repetitive Peak Reverse Voltage	V_{RM}			
Average Forward Current	I_F	-	200	mA
Repetitive Peak Forward Current	I_{FRM}	$t_p \leq 1 \text{ s}; \delta \leq 0.5$		
Non-repetitive Peak Forward Surge Current	I_{FSM}	$t_p \leq 10 \text{ ms}$		
Power Dissipation	P_D	-	200	mW
Thermal Resistance, Junction-Ambient (Air)	$R_{\theta JA}$	-	500	$^\circ\text{C}/\text{W}$
Operating Temperature Range	T_J	-	-55 ~ +150	$^\circ\text{C}$
Storage Temperature Range	T_{STG}	-		

2. Contents

1. Synopsis	1
1-1. Feature List.....	1
1-2. Applications	1
1-3. Mechanical Characteristics.....	1
1-4. Absolute Maximum Ratings	1
2. Contents	2
3. Electrical Property	3
3-1. Electrical Characteristics	3
3-2. Ratings and Characteristics Curve	3
4. Soldering Parameters	4
5. Package Information	5
5-1. Dimension.....	5
5-2. PCB Pad Layout Recommendation	5
6. Packing	6
6-1. Taping and Reel Specification	6
6-2. Embossed Carrier Tape Specification	6
6-3. Surface Mount Reel Specification.....	7
6-4. Tape Leader and Trailer Specification	7
7. Pin Out	8
8. Ordering Information	9
9. Version	9
9-1. History	9
9-2. Company Profile	9

3. Electrical Property

3-1. Electrical Characteristics

Parameter	Symbol	Conditions	Min.	Typ.	Max.	Units
Reverse Breakdown Voltage	V_{BR}	$I_R = 10\mu A$	40	-	-	V
Forward Voltage	V_F	$I_F = 1mA$	-	-	0.38	
		$I_F = 40mA$	-	-	1.0	
Reverse Recovery Time	t_{rr}	$I_F = I_T = 10mA$, $I_{rr} = 1mA$, $R_L = 100\Omega$	-	-	5.0	nS
Reverse Leakage Current	I_R	$V_R = 30V$, $T_J = 25^\circ C$	-	20	100	nA
Junction Capacitance	$C_{I/O}$	Pin Capacitance to GND. $V_{dc} = 0V$, $f = 1MHz$	-	4.0	5.0	pF

3-2. Ratings and Characteristics Curve ($T_A=25^\circ C$ unless otherwise noted)

Fig 1. Typical Forward Characteristics

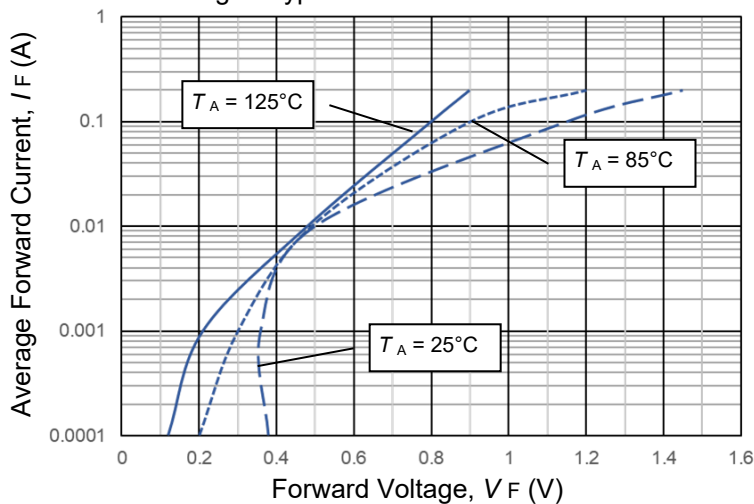

Fig 2. Reverse Current

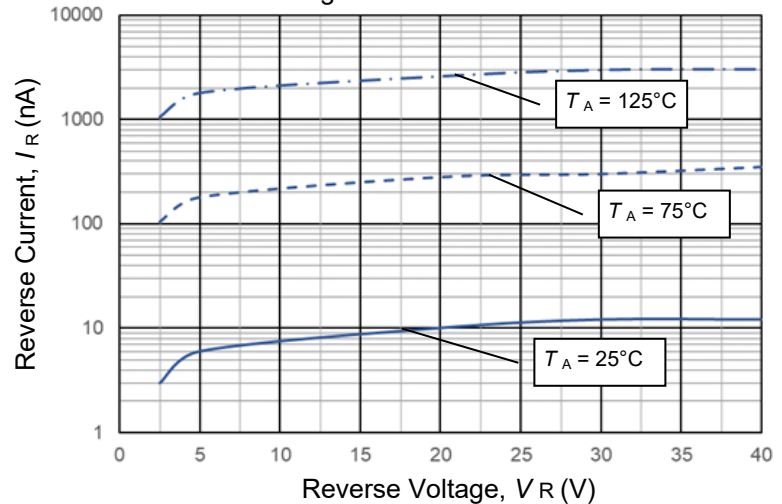

Fig 3. Typical Junction Capacitance

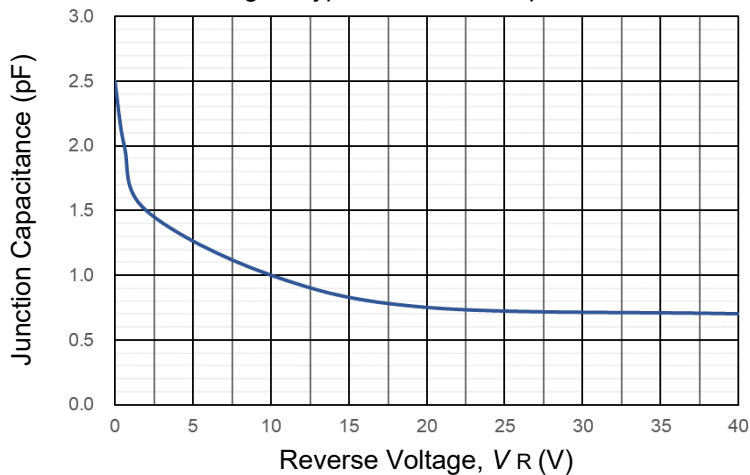
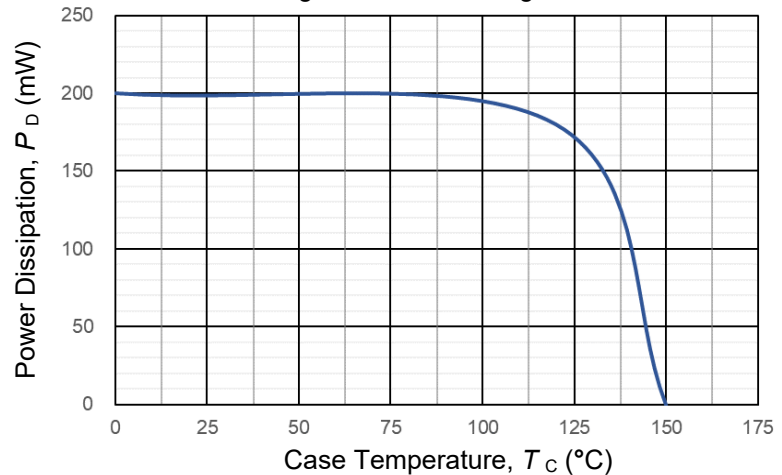
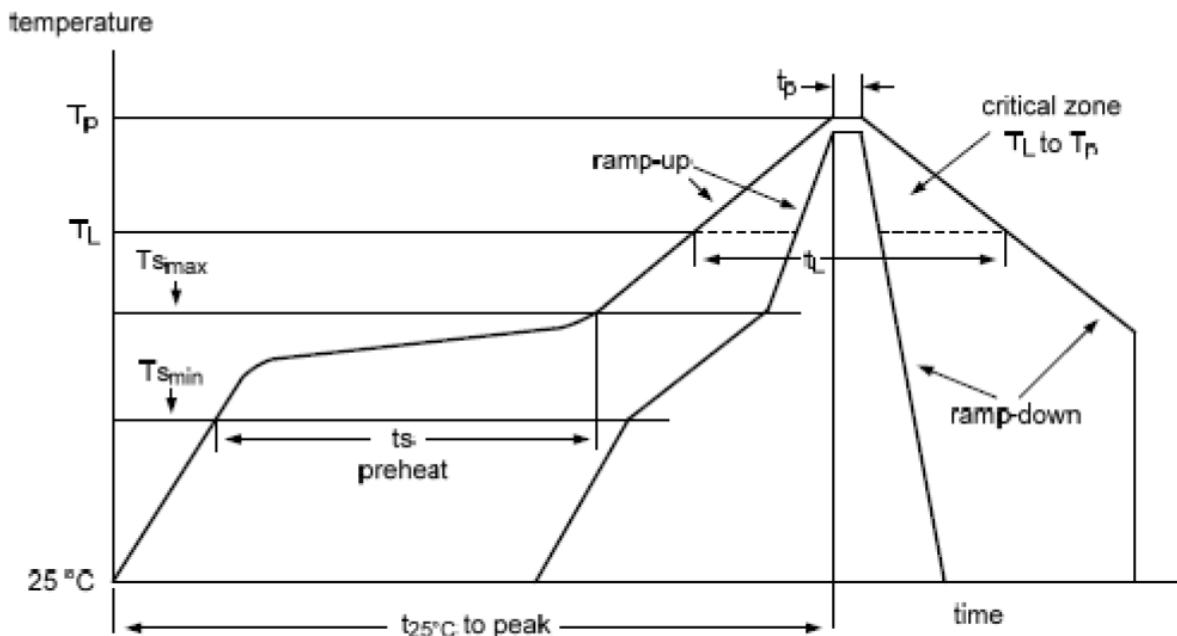

Fig 4. Power Derating Curve



4. Soldering Parameters

Profile Feature	SnPb eutectic assembly	Pb-free assembly
Average ramp-up rate (T _{smax} to T _p)	3 °C/s maximum	3 °C/s maximum
Preheat		
Temperature minimum (T _{smin})	100 °C	150 °C
Temperature maximum (T _{smax})	150 °C	200 °C
Time (t _{smin} to t _{smax})	60 s to 120 s	60 s to 180 s
Time maintained above		
Temperature (T _L)	183 °C	217 °C
Time (t _L)	60 s to 150 s	60 s to 150 s
Peak/classification temperature (T)	235 °C	260 °C
Number of allowed reflow cycles	3	3
Time within 5 °C of actual peak temperature (t _p)	10 s to 30 s	20 s to 40 s
Ramp-down rate	6 °C/s maximum	6 °C/s maximum
Time 25 °C to peak temperature	6 minutes maximum	8 minutes maximum



5. Package Information

5-1. Dimension

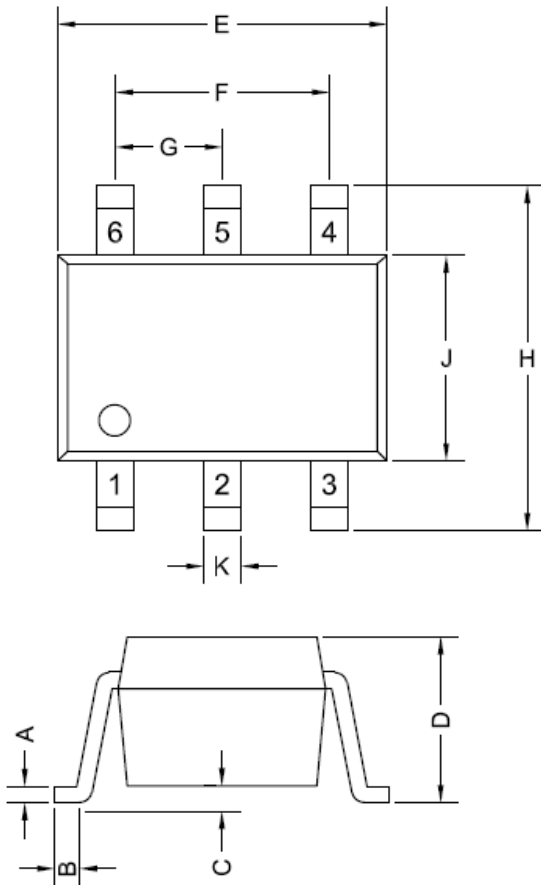

SOT363		
Symbol	Min.	Max
A	0.10	0.25
B	0.12	0.40
C	0.00	0.10
D	0.80	1.10
E	1.80	2.20
F	1.30	
G	0.65	
H	1.90	2.30
J	1.10	1.40
K	0.10	0.30

Unit: mm

5-2. PCB Pad Layout Recommendation

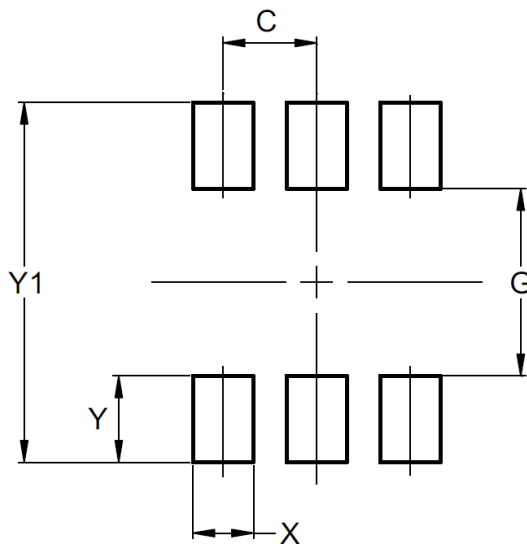

SOT363	
Symbol	Millimeter
C	0.65
G	1.10
X	0.42
Y	0.80
Y1	2.70

6. Packing

6-1. Taping and Reel Specification

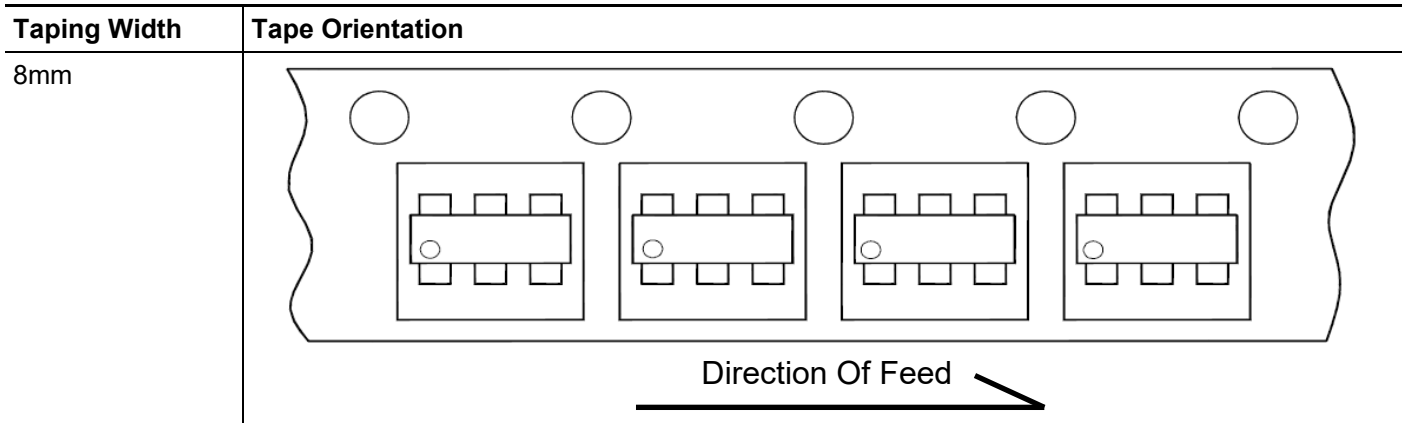

6-2. Embossed Carrier Tape Specification

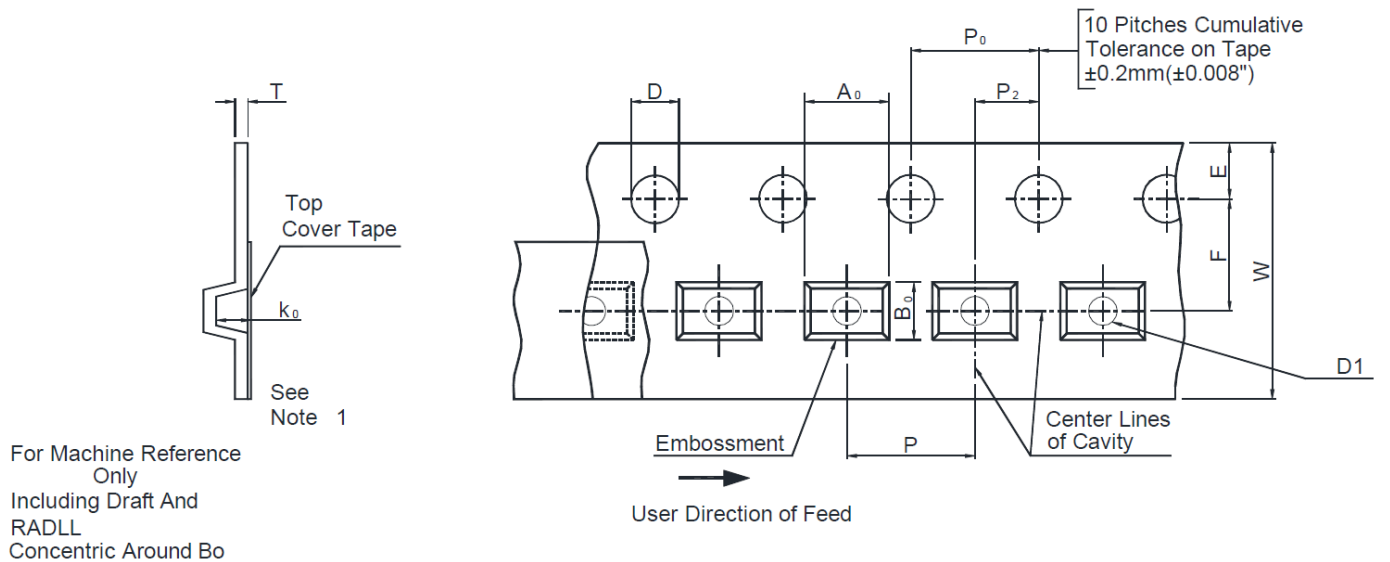

Dimension	W	D	D1	E	F	P	P0	P2	t	W
Value	8 mm	1.5 ±0.1	1.3 Max.	1.75 ±0.1	3.5 ±0.05	4 ±0.1	4 ±0.1	2 ±0.1	0.4 Max.	8 ±0.3
A0 / B0 / K0	Determined by Component Size. The Clearance Between The Component And The Cavity Must Comply to The Rotational and Lateral Movement Requirement Provided in Figures in The "Maximum Component Movement in Tape Pocket" Section.									

6-3. Surface Mount Reel Specification

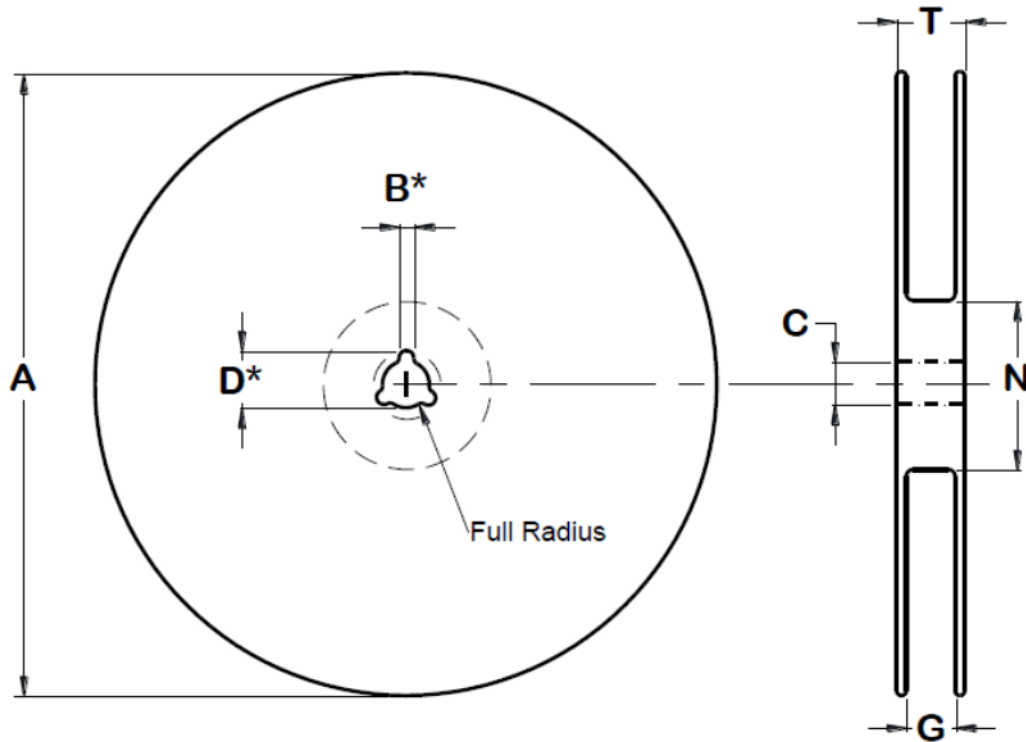

Unit: mm

Dimension	Tape Width	Reel Size	A	B	C	D	N	G	T
Values	8 mm	7"	178 ±2	2.0 +0.5/-0	13 +0.5/-0.2	20.5 ±0.2	55 ±5	8.4 +1.5/-0.0	14.4

6-4. Tape Leader and Trailer Specification

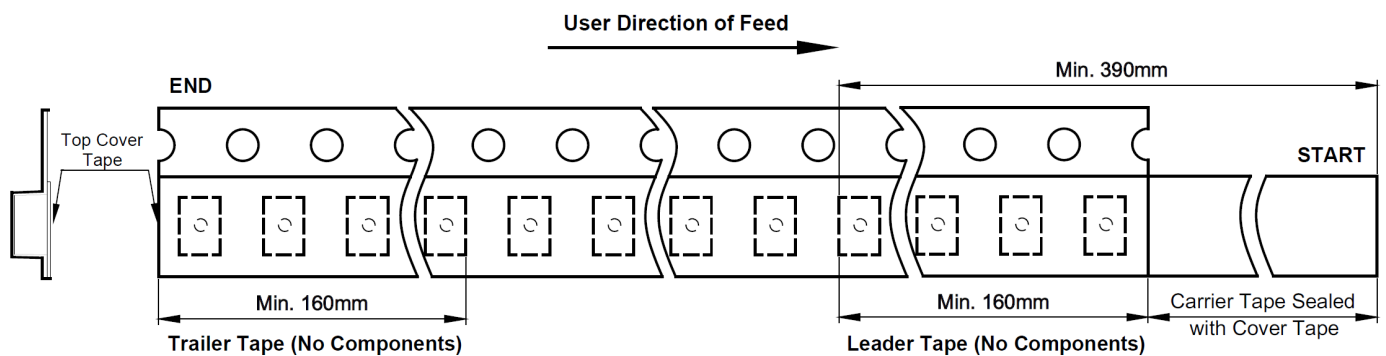

7. Pin Out

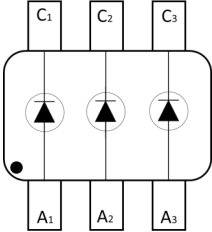
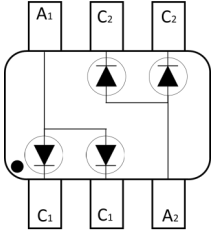
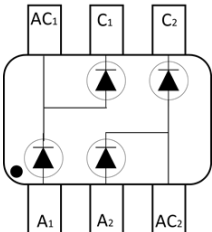
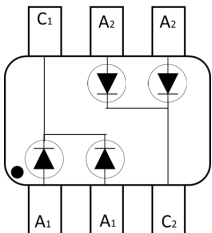
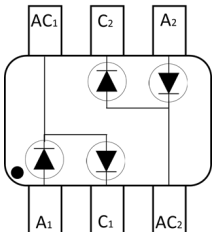
Part Number	Symbol
BAS40DW	
BAS40ADW	
BAS40BDW	
BAS40CDW	
BAS40SDW	

8. Ordering Information

Part Number	Marking Code	Component Package	Quantity	Packaging Option
BAS40DW	4AF	SOT363	3,000 PCS	Tape & Reel - 8mm tape / 7" reel
BAS40ADW	4DF			
BAS40BDW	4EF			
BAS40CDW	4CF			
BAS40SDW	4BF			

9. Version

9-1. History

Version	Date	File No.	Recording	Basis
A	07-Feb-2018	F21837T	New Create	Market
B	22-Apr-2019		Update Company Info.	System
2.0	22-Apr-2021		Update Version	System
2.1	27-Dec-2021		Update Version	System