

# FKC08W SERIES

DC-DC CONVERTER

4:1 ULTRA WIDE INPUT RANGE  
 UP TO 8 Watts

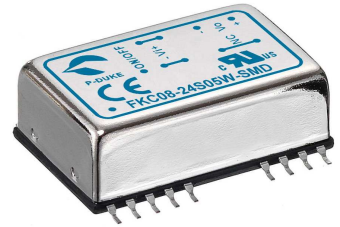
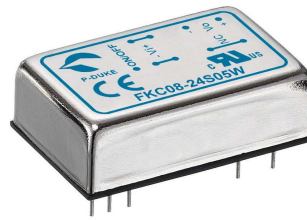

## FEATURES

- NO MINIMUM LOAD REQUIRED
- 1600VDC INPUT TO OUTPUT ISOLATION
- STANDARD 1.25 X 0.80 X 0.40 INCH 24 PIN DIP AND SMD PACKAGE
- UL60950-1, EN60950-1, & IEC60950-1 SAFETY APPROVALS
- COMPLIANCE TO EN50155 AND EN45545-2 RAILWAY STANDARD
- CE MARKED
- COMPLIANT TO RoHS II & REACH

## APPLICATIONS

- RAILWAY SYSTEM
- WIRELESS NETWORK
- TELECOM/DATACOM
- INDUSTRY CONTROL SYSTEM
- DISTRIBUTED POWER ARCHITECTURES
- SEMICONDUCTOR EQUIPMENT

<b>1600VDC ISOLATION</b>	<b>REMOTE CONTROL</b>	<b>UVP</b>	<b>OCP</b>	<b>SCP</b>
--------------------------	-----------------------	------------	------------	------------

## TECHNICAL SPECIFICATION

All specifications are typical at nominal input, full load and 25°C otherwise noted

Model Number	Input Range VDC	Output Voltage VDC	Output Current @ Full Load mA	Input Current @ No Load mA	Efficiency %	Maximum Capacitor Load µF
FKC08-24S3P3W	9 ~ 36	3.3	2400	40	85	1330
FKC08-24S05W	9 ~ 36	5	1600	40	87	1330
FKC08-24S12W	9 ~ 36	12	666	25	86	288
FKC08-24S15W	9 ~ 36	15	533	25	86	200
FKC08-24D05W	9 ~ 36	±5	±800	20	84	±900
FKC08-24D12W	9 ~ 36	±12	±333	25	86	±133
FKC08-24D15W	9 ~ 36	±15	±267	25	86	±90
FKC08-48S3P3W	18 ~ 75	3.3	2400	20	85	1330
FKC08-48S05W	18 ~ 75	5	1600	20	87	1330
FKC08-48S12W	18 ~ 75	12	666	13	87	288
FKC08-48S15W	18 ~ 75	15	533	13	88	200
FKC08-48D05W	18 ~ 75	±5	±800	10	84	±900
FKC08-48D12W	18 ~ 75	±12	±333	13	87	±133
FKC08-48D15W	18 ~ 75	±15	±267	13	87	±90
FKC08-110S3P3W	43 ~ 160	3.3	2400	8	84	1330
FKC08-110S05W	43 ~ 160	5	1600	8	85	1330
FKC08-110S12W	43 ~ 160	12	666	4	86	288
FKC08-110S15W	43 ~ 160	15	533	4	86	200
FKC08-110D05W	43 ~ 160	±5	±800	5	82	±900
FKC08-110D12W	43 ~ 160	±12	±333	5	85	±133
FKC08-110D15W	43 ~ 160	±15	±267	5	85	±90

## PART NUMBER STRUCTURE

<b>FKC08</b>	<b>- 48</b>	<b>S</b>	<b>05</b>	<b>W</b>	<b>- SMD</b>
Series Name	Input Voltage (VDC)	Output Quantity	Output Voltage (VDC)	Input Range	Mounting Type Option
	24: 9~36 48: 18~75 110: 43~160	S: Single	3P3: 3.3 05: 5 12: 12 15: 15	4: 1	□: DIP type SMD: SMD type
		D: Dual	05: ± 5 12: ±12 15: ±15		

**INPUT SPECIFICATIONS**

Parameter	Conditions			Min.	Typ.	Max.	Unit
Operating input voltage range	24Vin(nom)			9	24	36	VDC
	48Vin(nom)			18	48	75	
	110Vin(nom)			43	110	160	
Start up voltage	24Vin(nom)					9	VDC
	48Vin(nom)					18	
	110Vin(nom)					43	
Shutdown voltage	24Vin(nom)				8		VDC
	48Vin(nom)				16		
	110Vin(nom)				40		
Start up time	Constant resistive load	Power up		450			ms
Input surge voltage	100 ms, max.	Remote ON/OFF			5		
		24Vin(nom)				50	VDC
		48Vin(nom)				100	
110Vin(nom)				170			
Input reflected ripple current				20			mAp-p
Input filter				Pi type			
Remote ON/OFF	Referred to -Vin pin	Positive logic	DC-DC ON		Open or 3.0 ~ 12VDC		
			DC-DC OFF		Short or 0 ~ 1.2VDC		
			Input current of Ctrl pin	-0.5		+0.5	mA
		Remote off input current			2.5		mA

**OUTPUT SPECIFICATIONS**

Parameter	Conditions			Min.	Typ.	Max.	Unit
Voltage accuracy				-1.0		+1.0	%
Line regulation	Low Line to High Line at Full Load			-0.2		+0.2	%
Load regulation	No Load to Full Load	DIP type	Single	-0.5		+0.5	%
			Dual	-1.0		+1.0	
	10% Load to 90% Load	SMD type	Single	-1.0		+1.0	
			Dual	-1.0		+1.0	
		DIP type	Single	-0.3		+0.3	
			Dual	-0.8		+0.8	
	SMD type	Single	-0.8		+0.8		
		Dual	-0.8		+0.8		
Cross regulation	Asymmetrical load 25%/100% FL		Dual	-5.0		+5.0	%
Ripple and noise	20MHz bandwidth	24Vin(nom)			50		mVp-p
		48Vin(nom)			50		
		110Vin(nom)			75		
Temperature coefficient				-0.02		+0.02	%/°C
Transient response recovery time	25% load step change				250		µs
Over voltage protection	Single Output	3.3Vout			3.9		VDC
		5Vout			6.2		
		12Vout			15		
		15Vout			18		
Over load protection	% of Iout rated				150		%
Short circuit protection				Continuous, automatic recovery			

**GENERAL SPECIFICATIONS**

Parameter	Conditions			Min.	Typ.	Max.	Unit
Isolation voltage	1 minute	DIP type	Input to Output	1600			VDC
			Input (Output) to Case	1600			
	SMD type	Input to Output	1600				
		Input (Output) to Case	1000				
Isolation resistance	500VDC			1			GΩ
Isolation capacitance						1500	pF
Switching frequency				270	300	330	kHz
Safety approvals				UL60950-1 EN60950-1 IEC60950-1			
Case material				Nickel-coated copper			
Base material				Non-conductive black plastic			
Potting material				Epoxy (UL94 V-0)			
Weight				18g (0.62oz)			
MTBF	MIL-HDBK-217F						2.832 x 10 <sup>6</sup> hrs

**ENVIRONMENTAL SPECIFICATIONS**

Parameter	Conditions	Min.	Typ.	Max.	Unit
Operating ambient temperature <sup>(1)</sup>	3.3Vout, ±5Vout	-40		+70	°C
		Without derating			
		With derating		+105	
	Others	-40		+78	
		Without derating			
		With derating		+105	
Maximum case temperature				105	°C
Storage temperature range		-55		+125	°C
Thermal impedance	Natural convection		20		°C/W
Thermal shock					MIL-STD-810F
Shock					EN61373, MIL-STD-810F
Vibration					EN61373, MIL-STD-810F
Relative humidity					5% to 95% RH

**EMC SPECIFICATIONS**

Parameter	Conditions	Level
EMI <sup>(2)</sup>	EN55022, EN55011	Class A · Class B
ESD	EN61000-4-2	Air ± 8kV and Contact ± 6kV
Radiated immunity	EN61000-4-3	20 V/m
Fast transient <sup>(3)</sup>	EN61000-4-4	± 2kV
Surge <sup>(3)</sup>	EN61000-4-5	± 2kV
Conducted immunity	EN61000-4-6	10 Vr.m.s
Power frequency magnetic field	EN61000-4-8	100A/m continuous; 1000A/m 1 second

**Note:**

- Converter can meet the railway T2 and TX temperature requirement.  
T2: -40 °C ~ +70 °C as all models; TX: -40 °C ~ +85 °C as power derating to 55% output power.
- The standard module meets EMI Class A or Class B with external components. For further information, please contact with P-DUKE.
- An external input filter capacitor is required if the module has to meets EN61000-4-4, EN61000-4-5.  
The filter capacitor Power Mate suggest: : 24Vin/48Vin Nippon chemi-con KY series, 220µF/100V  
: 110 Vin Nippon chemi-con KXJ series, 150µF/200V

**CAUTION:** This power module is not internally fused. An input line fuse must always be used.

**CHARACTERISTIC CURVE**

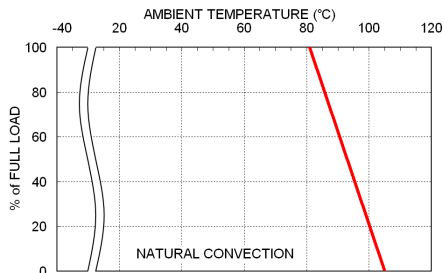

FKC08-48S05W Derating Curve

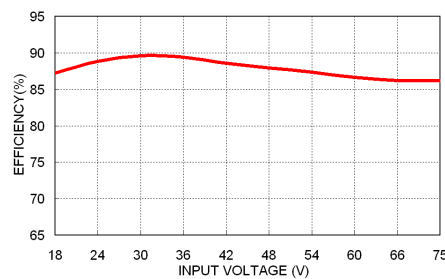

FKC08-48S05W Efficiency vs. Input Voltage

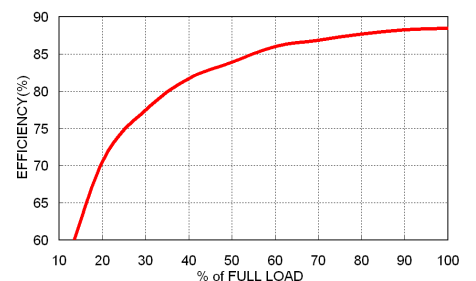

FKC08-48S05W Efficiency vs. Output Load

**MECHANICAL DRAWING**

**DIP type**

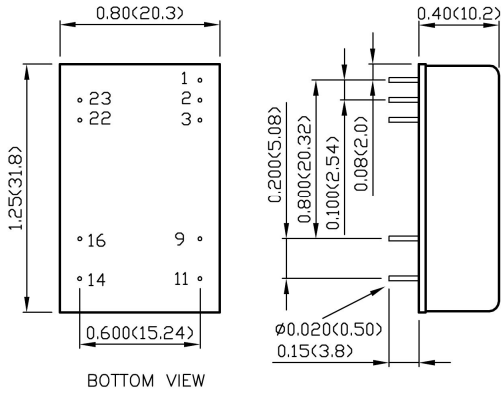

**PIN CONNECTION**

PIN	SINGLE	DUAL	PIN	SINGLE	DUAL
1	Ctrl	Ctrl			
2	-Vin	-Vin	23	+Vin	+Vin
3	-Vin	-Vin	22	+Vin	+Vin
9	NC	Common	16	-Vout	Common
11	NC	-Vout	14	+Vout	+Vout

**SMD type**

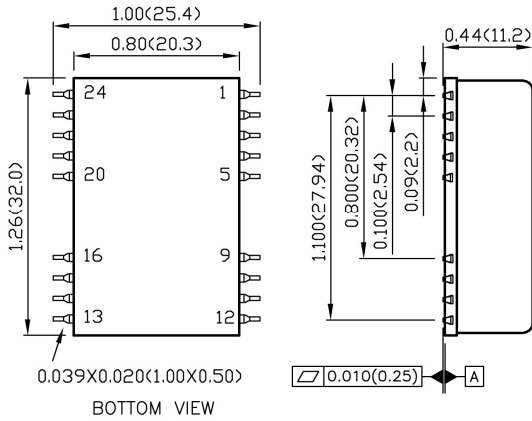

**PIN CONNECTION**

PIN	SINGLE	DUAL	PIN	SINGLE	DUAL
1	Ctrl	Ctrl			
2	-Vin	-Vin	23	+Vin	+Vin
3	-Vin	-Vin	22	+Vin	+Vin
9	NC	Common	16	-Vout	Common
11	NC	-Vout	14	+Vout	+Vout
Others	NC	NC			

1. All dimensions in inch (mm)
2. Tolerance : x.xx±0.02 (x.x±0.5)  
x.xxx±0.01 (x.xx±0.25)
3. Pin pitch tolerance ±0.01 (0.25)
4. Pin dimension tolerance ±0.004(0.1)