

FEATURES:

- Effective for suppressing common mode noise at high frequency
- Excellent solderability
- Compact design

APPLICATIONS:

- Common mode noise suppression of differential signal lines in high speed and high-density digital equipments such as USB 2.0, IEEE1394, LVDS, Digital Camera, Scanner, etc.
- Digital audio and video equipments such as PDA, DSC, DVC, CD Player, DVD Player, etc.

ELECTRICAL SPECIFICATIONS:

Operating Temperature: -40°C to +85°C

Storage Temperature: -10°C to +40°C, 70% RH max

Parameters	Minimum	Typical	Maximum	Units	Notes
Center Frequency	-----	480.0	-----	MHz	
Common Mode Attenuation	10	-----	-----	dB	@130MHz ~ 1GHz
Differential Mode Insertion Loss	-----	-----	0.6	dB	@240MHz
DC Resistance	-----	-----	2.0	Ω	
Rated Current	-----	-----	200	mA	
Characteristic Impedance	90			Ω	

Unless otherwise specified, the standard atmospheric conditions for measurement/test as:

- Ambient Temperature: 20±15°C
- Relative Humidity: 65%±20%
- Air Pressure: 86 KPa to 106 KPa

Visual Examination

- Inspection Equipment: 20X magnifier

Electrical Test

- Impedance Analyzer: HP4991A.
- Network Analyzer: HP8719ES.

ELECTRICAL PROPERTIES

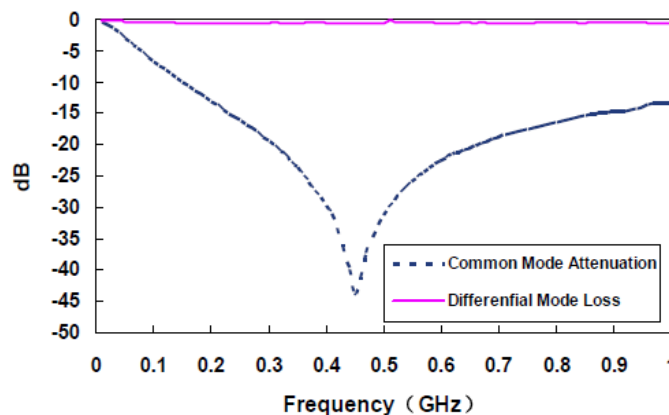

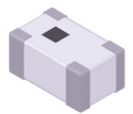

OUTLINE DRAWING:

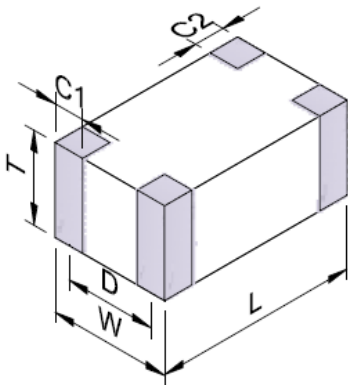

L	W	T	C1	C2	D
3.2±0.2	1.6±0.2	0.9±0.1	0.5±0.2	0.4±0.2	1.1±0.1

Recommended Land Pattern

Schematic

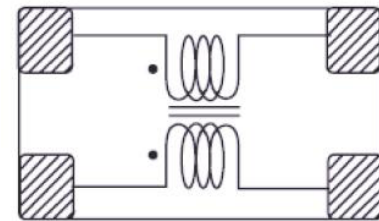
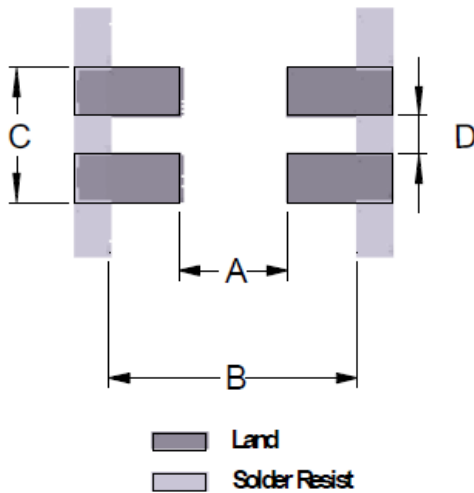

A	B	C	D
1.6	3.7	1.6	0.4

Dimension: mm

REFLOW PROFILE:

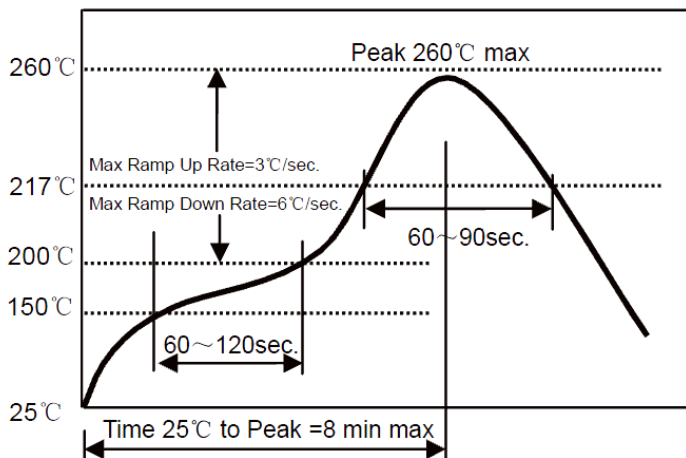

- Preheat condition: 150 ~200°C/60~120sec.
- Allowed time above 217°C: 60~90sec.
- Max temp: 260°C
- Max time at max temp: 10sec.
- Solder paste: Sn/3.0Ag/0.5Cu
- Allowed Reflow time: 2x max



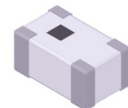

3.2 x 1.6 x 0.9mm

ACMF-31B



RoHS
Compliant

TAPE & REEL:

T= tape and reel (3,000pcs/reel)

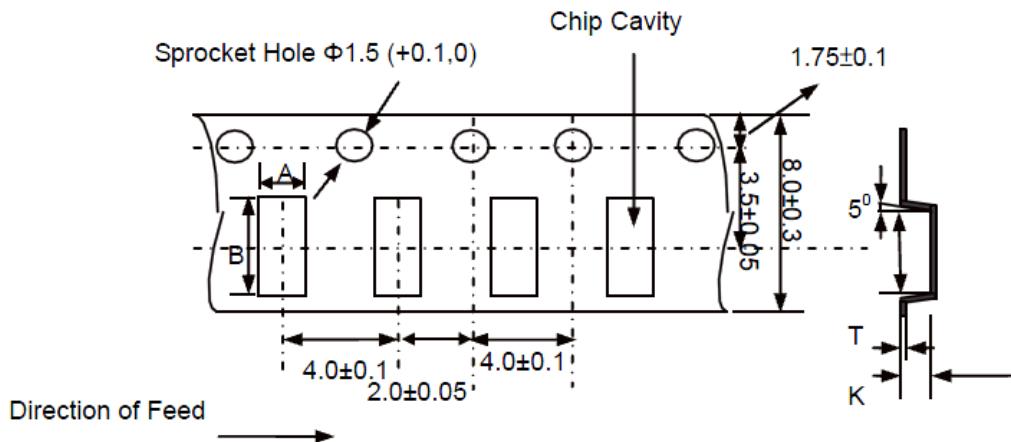

A	B	K max	T max
1.85±0.10	3.50±0.10	1.14	0.27

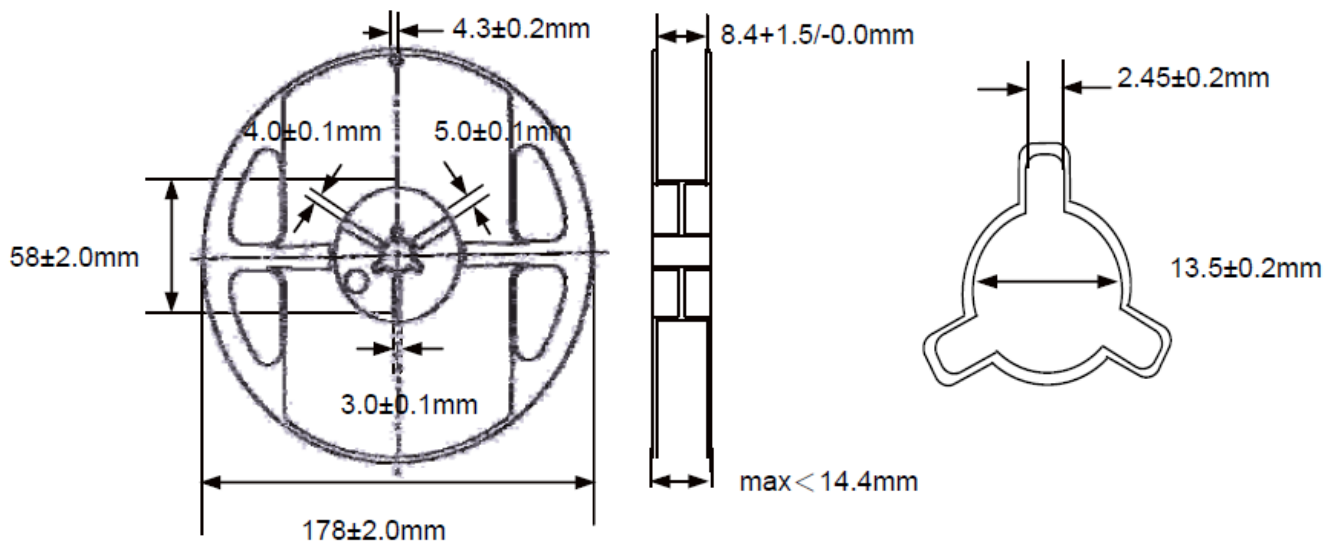

Dimension: mm

ATTENTION: Abracon Corporation's products are COTS – Commercial-Off-The-Shelf products; suitable for Commercial, Industrial and, where designated, Automotive Applications. Abracon's products are not specifically designed for Military, Aviation, Aerospace, Life-dependant Medical applications or any application requiring high reliability where component failure could result in loss of life and/or property. For applications requiring high reliability and/or presenting an extreme operating environment, written consent and authorization from Abracon Corporation is required. Please contact Abracon Corporation for more information.

