

### Product Features

- GaN on SiC HEMT
- 2-Stage Amplifier 50ohms Matching
- Surface Mount Hybrid Type
- Small Size & Mass
- High Efficiency

### Applications

- RF Sub-Systems
- Base Station
- Repeater
- 4G/LTE system
- Small cell



Package Type : NP-1EL

### Description

The HT0808-15A is designed for LTE Repeater & RF Sub-systems application frequencies from 869 ~ 894MHz. This amplifier uses GaN HEMT technology which performs high breakdown voltage, high efficiency, high In/Output impedance, High power density.

### Electrical Specifications @ $V_{ds} = 28V$ , $T_a = 25^\circ C$

PARAMETER	UNIT	MIN	TYP	MAX	CONDITION
Frequency Range	MHz	869	-	894	ZS = ZL = 50 ohm
Power Gain	dB	34	37	39	Amp : Idq1 = 50mA Idq2 = 105mA
Gain Flatness		-	0.6	-	
Input Return Loss		-	-10	-6.0	
Pout @ Average	dBm	-	33	-	
Pout @ Psat	dBm	40.8	41.5	-	Pulse Width=50us, 10%Duty
ACLR @ BW 10MHz LTE (PAPR 7.5dB)	dBc	-	-32	-27	Non DPD
		-	-53	-	With DPD
Drain Efficiency	%	23	26	-	Pout @ Average
Total Ids	mA	-	280	-	
Supply Voltage	V	-	-3.0	-2.0	Gate Bias (Vgs1 and Vgs2)
	V	-	28	-	Main Bias(Vds)

#### Caution

The drain voltage must be supplied to the device after the gate voltage is supplied  
 Turn on : Turn on the Gate Voltage supply and last turn On the Drain voltage supplies  
 Turn off : Turn off the Drain Voltage and last turn off the Gate voltage

#### Note

1. ACLR Measured Pout=33dBm @  $f_c \pm 10MHz / 9.015MHz$   
 LTE 10MHz 1FA PAPR=7.5dB @ 0.01% probability on CCDF, (DPD Engine: Optichron OP6180)
2. HT Series have internal DC blocking capacitors at the RF input and output ports

### Mechanical Specifications

PARAMETER	UNIT	TYP	REMARK
Mass	g	2	-
Dimension	mm	20.5 x 15 x 3.5	-

## Absolute Maximum Ratings

PARAMETER	UNIT	RATING	SYMBOL
Gate-Source Voltage	V	-10 ~ 0	Vgs1 Vgs2
Drain-Source Voltage	V	50	Vds
Gate Current	mA	5.7	Ig
Operating Junction Temperature	°C	225	T <sub>J</sub>
Operating Case Temperature	°C	-30 ~ 85	T <sub>C</sub>
Storage Temperature	°C	-40 ~ 100	T <sub>STG</sub>
Maximum RF Input Level	dBm	25	Pin

## Operating Voltage &amp; Input Level

PARAMETER	UNIT	MIN	TYP	MAX	SYMBOL
Drain Voltage	V	27.5	28	28.5	Vds
Gate Voltage (on-stage)	V	-	-3	-2	Vgs 1
Gate Voltage (on-stage)	V	-	-3	-2	Vgs 2
Gate Voltage (off-stage)	V	-	-8	-	Vgs 1
Gate Voltage (off-stage)	V	-	-8	-	Vgs 2
Idq1	mA	48.5	50	52.5	Idq1
Idq2	mA	100	105	110	Idq2
RF Input Level	dBm	-	-	20	Pin

## Block Diagram

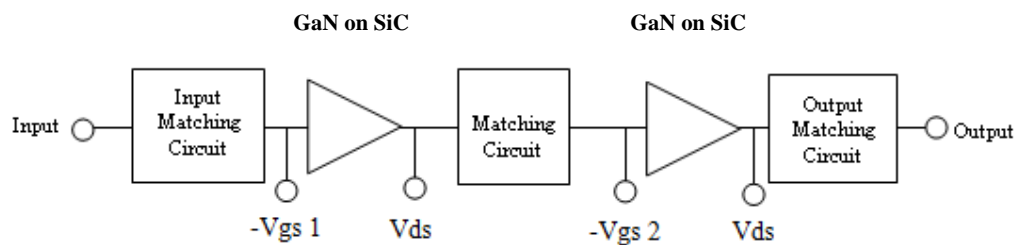

Application Circuit

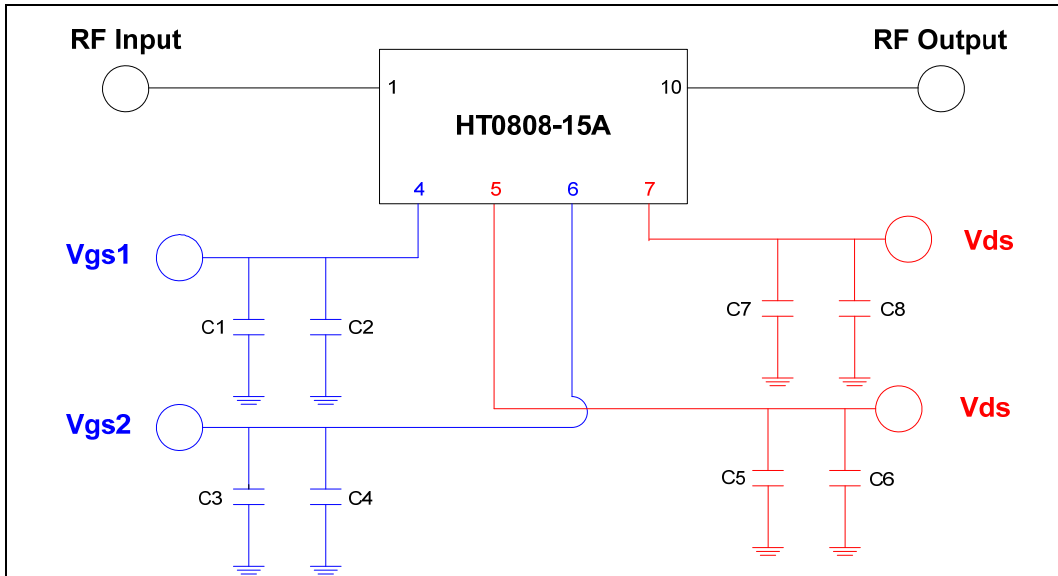

Part List

Location	Model No.	Spec.	Maker
C6, C8	1812C225K101CT	2.2uF / 100V	WALSIN
C1, C3	C3216X7R1C106K	10uF / 16V	TDK
C2, C4, C5, C7	201CHA390JSLE	39pF	TEMEX
Evaluation Board	RO4350B	2Layer, 30mil	ROGERS

Performance Charts

\* Bias condition @ Idq1= 50mA, Idq2= 105mA, Ta=25°C

Power Gain vs. Frequency

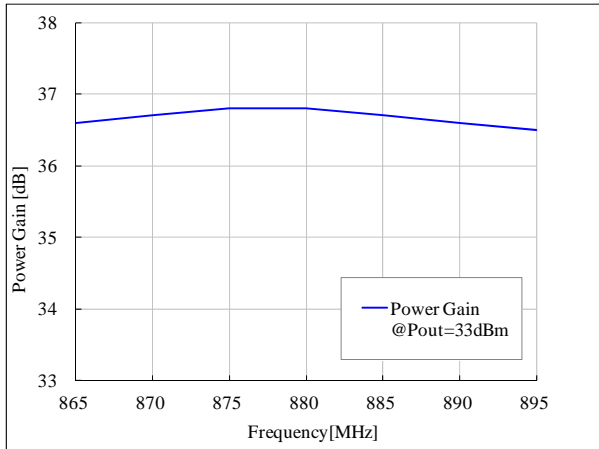

Psat vs. Frequency

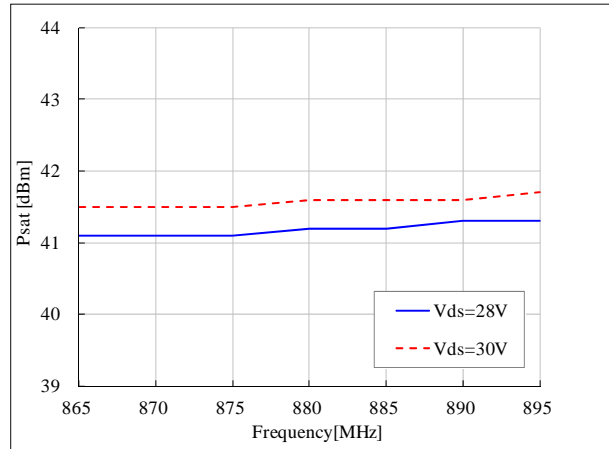

ACLR vs. Frequency

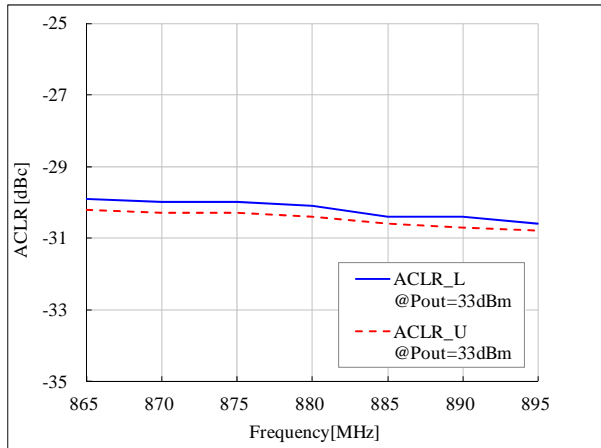

Efficiency vs. Frequency

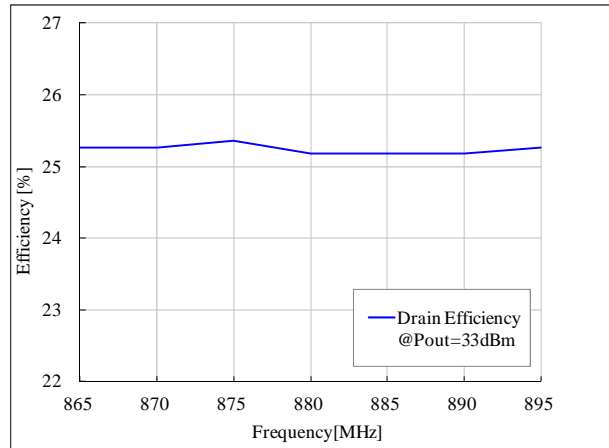

Ids1 vs. Ids2 vs. Frequency

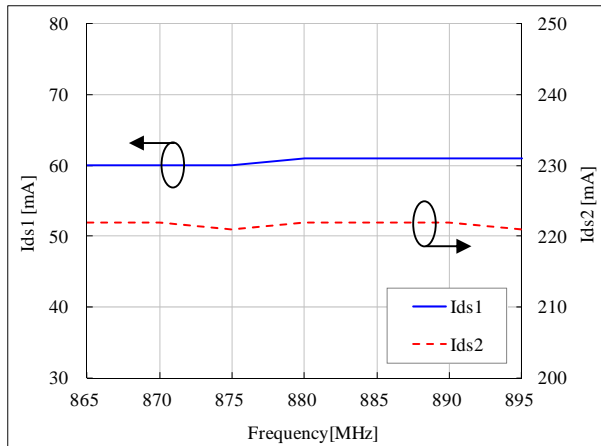

Total Ids vs. Frequency

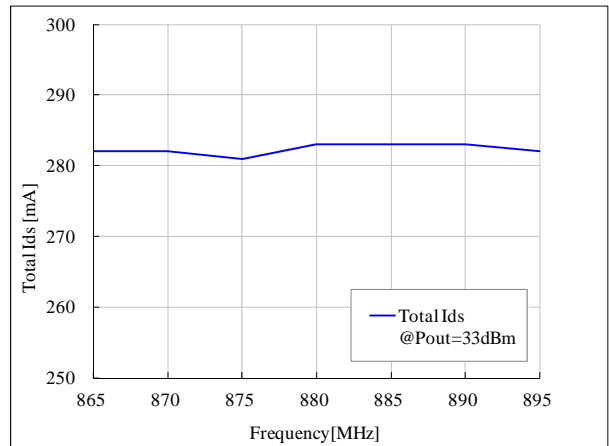

Performance Charts

\* Bias condition @ Idq1= 50mA, Idq2= 105mA, Ta=25°C

Power Gain vs. Output Power

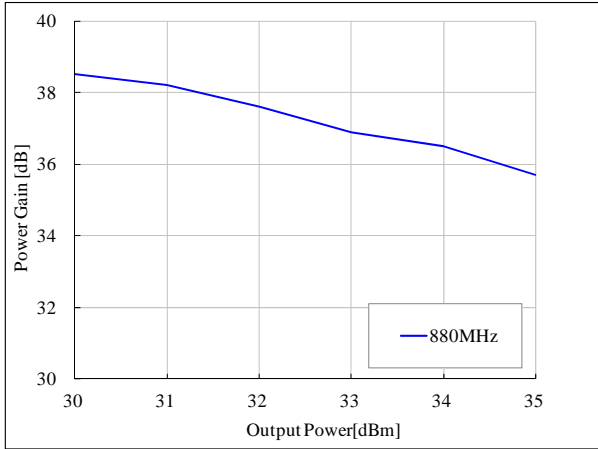

Efficiency vs. Output Power

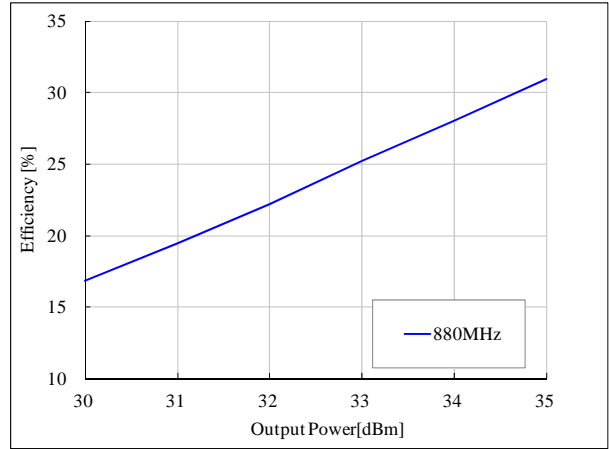

ACLR vs. Output Power

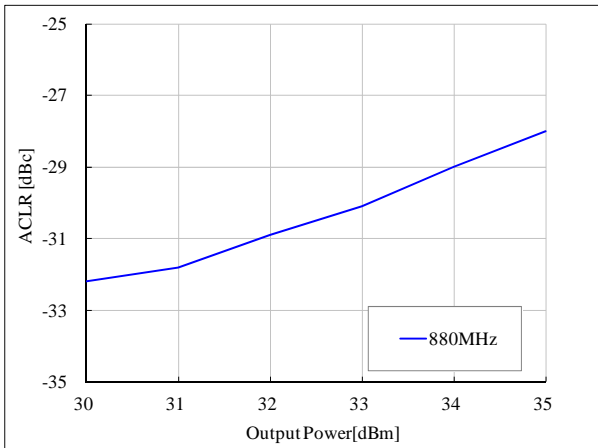

Ids1 vs. Output Power

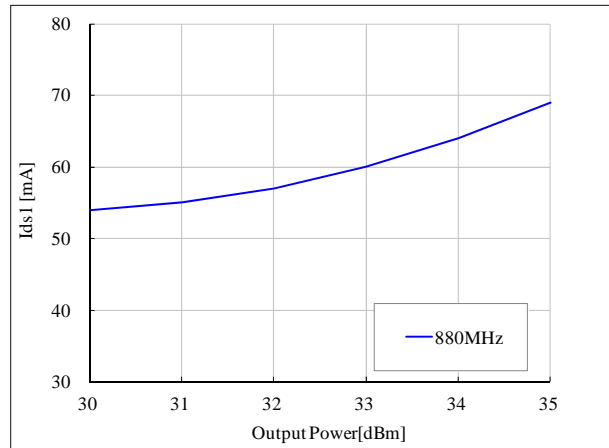

\*LTE 10MHz (PAPR=7.5dB) w/o DPD

Ids2 vs. Output Power

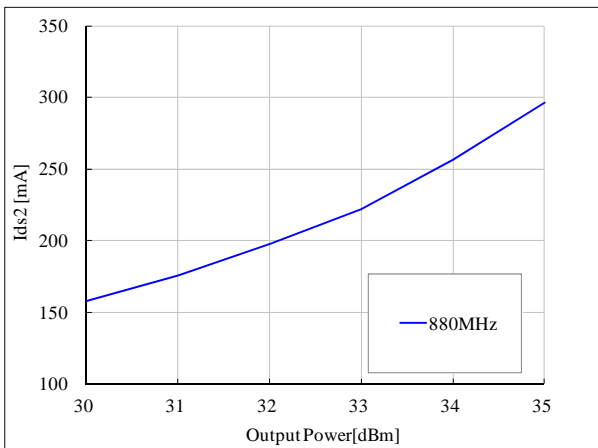

Package Dimensions (Type: NP-1EL)

\* Unit: mm[inch] | Tolerance: ±0.15[.006]

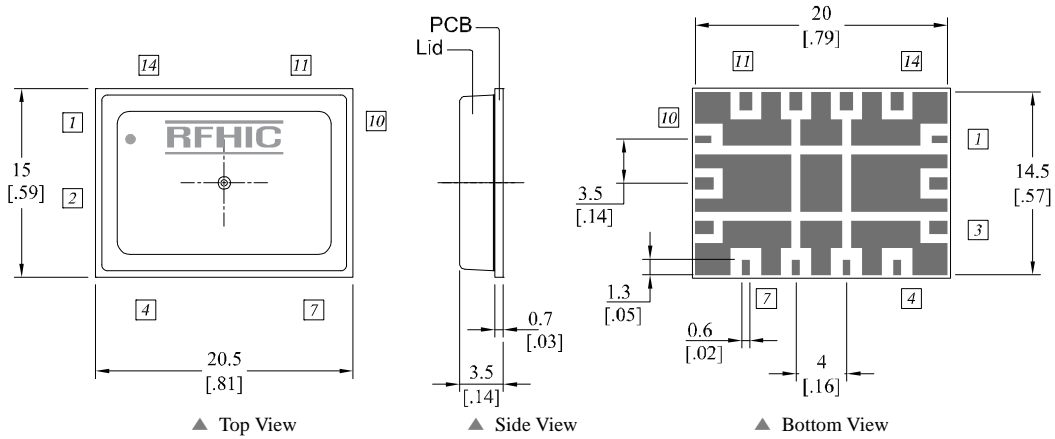

Pin Description							
Pin No	Function	Pin No	Function	Pin No	Function	Pin No	Function
1	RF Input	4	Vgs1	8	GND	11	GND
2	GND	5	Vds	9	GND	12	GND
3	GND	6	Vgs2	10	RF Output	13	GND
-	-	7	Vds	-	-	14	GND

Recommended Pattern

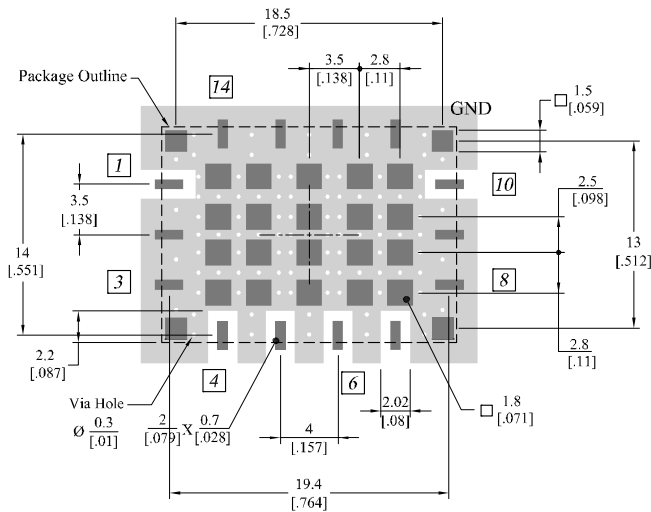

Recommended Mounting Configuration

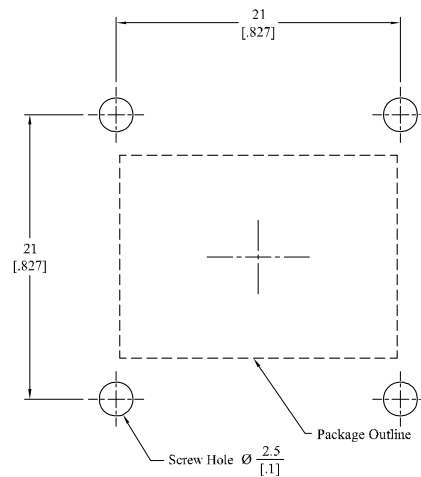

\* Mounting Configuration Notes

1. For the proper performance of the device, Ground / Thermal via holes must be designed to remove heat.
2. To properly use heatsink, ensure the ground/thermal via hole region to contact the heatsink. We recommend the mounting screws be added near the heatsink to mount the board
3. In designing the necessary RF trace, width will depend upon the PCB material and construction.
4. Use 1 oz. Copper minimum thickness for the heatsink.
5. Do not put solder mask on the backside of the PCB in the region where the board contacts the heatsink
6. We recommend adding as much copper as possible to inner and outer layers near the part to ensure optimal thermal performance.

## Precautions

This product is a Gallium Nitride Transistor.

The Gallium Nitride Transistor requires a Negative Voltage Bias which operates alongside a Positive Voltage Bias. These Biases are applied in accordance to the Sequence during Turn-On and Turn-Off.

The Pallet Amplifier does not have a built-in Bias Sequence Circuit. Therefore, users need to either apply positive voltages and negative voltages in the required sequence, or add an external Bias Circuit to this Amplifier.

The required sequence for power supply is as follows.

## During Turn-On

1. Connect GND.
2. Apply Vgs1 and Vgs2.
3. Apply Vds.
4. Apply the RF Power.

## During Turn-Off

1. Turn off RF power.
2. Turn off Vds, and then, turn off the Vgs1 and Vgs2.
3. Remove all connections.

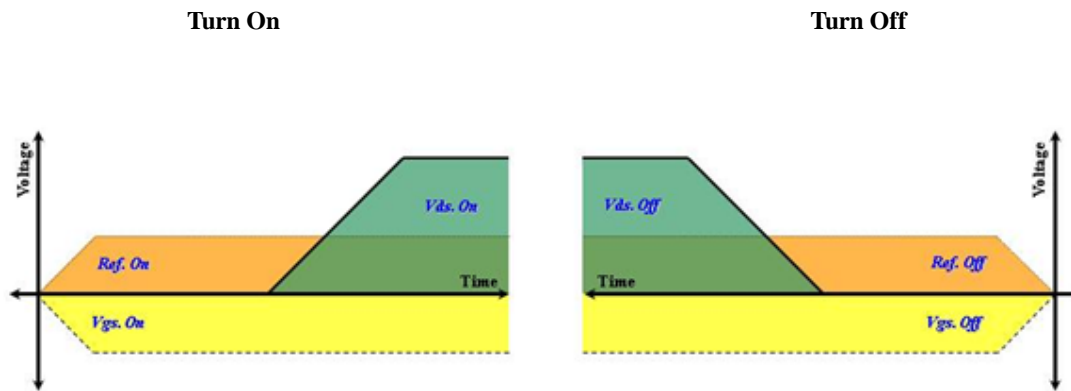

- Sequence Timing Diagram -

## Reflow Profile

### \* Reflow oven settings

Zone	A	B	C	D	E	F
Temperature(°C)	30 ~ 150 °C	150 ~ 180 °C	180 ~ 220 °C	220 ~ 220 °C	235 ~ 240 °C	2 ~ 6 °C/ Sec Drop
Belt speed	55 ~ 115 sec	55 ~ 75 sec	30 ~ 50 sec	30 ~ 50 sec	5 ~ 10 sec	60 ~ 90 sec

Reflow Cycle Limit= 1time

### \* Measured reflow profile

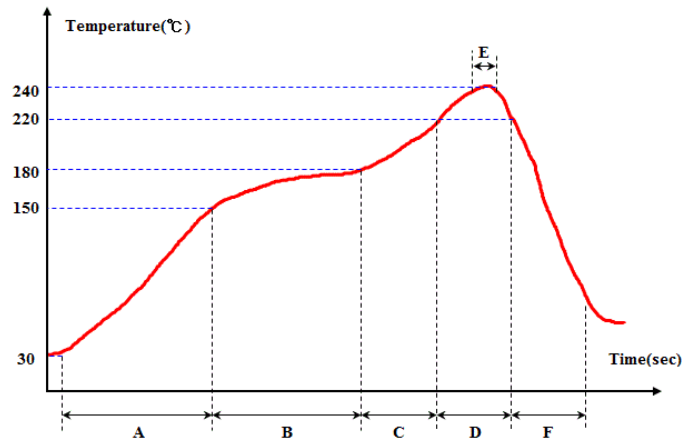

## Ordering Information

Part Number	Package Design
HT0808-15A	-R (Reel)
	-B (Bulk)
	-EVB (Evaluation Board)

## Revision History

Part Number	Release Date	Version	Modification	Data Sheet Status
HT0808-15A	2013.04.19	1.0	Electrical Specification (1p)	-
HT0808-15A	2013.04.11	0.6	Application Circuit Package Dimensions Reflow profile	Preliminary
HT0808-15A	2012.12.27	0.5	Changed Case Temperature	Preliminary

RFHIC Corporation reserves the right to make changes to any products herein or to discontinue any product at any time without notice. While product specifications have been thoroughly examined for reliability, RFHIC Corporation strongly recommends buyers to verify that the information they are using is accurate before ordering. RFHIC Corporation does not assume any liability for the suitability of its products for any particular purpose, and disclaims any and all liability, including without limitation consequential or incidental damages. RFHIC products are not intended for use in life support equipment or application where malfunction of the product can be expected to result in personal injury or death. Buyer uses or sells such products for any such unintended or unauthorized application, buyer shall indemnify, protect and hold RFHIC Corporation and its directors, officers, stockholders, employees, representatives and distributors harmless against any and all claims arising out of such unauthorized use.

Sales, inquiries and support should be directed to the local authorized geographic distributor for RFHIC Corporation. For customers in the US, please contact the US Sales Team at 919-677-8780. For all other inquiries, please contact the International Sales Team at 82-31-250-5078.