

**■Features**

- Top view white LED (5.6x3.0x0.9mm)
- Super high brightness of surface mount LED
- Lead frame package with individual 4 pins
- ESD protection
- Compatible to IR reflow soldering.

**■Applications**

- General lighting
- Decoration lighting
- Indicator

**■Outline Dimension**

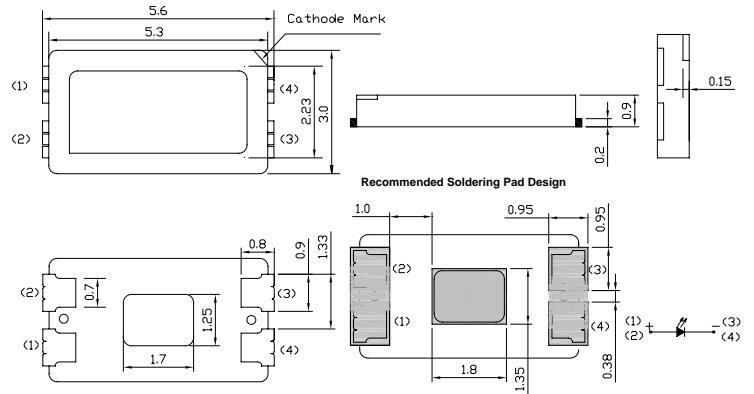

**■Absolute Maximum Rating**

(Ta=25 )

Item	Symbol	Value	Unit
DC Forward Current	I <sub>F</sub>	80	mA
Pulse Forward Current*	I <sub>FP</sub>	100	mA
Reverse Voltage	V <sub>R</sub>	5	V
Power Dissipation	P <sub>D</sub>	280	mW
Operating Temperature	T <sub>opr</sub>	-30 ~ +85	
Storage Temperature	T <sub>stg</sub>	-40 ~ +100	
Lead Soldering Temperature	T <sub>sol</sub>	260 /10sec	-

\*Pulse width Max 0.1ms, Duty ratio max 1/10

**■Directivity**

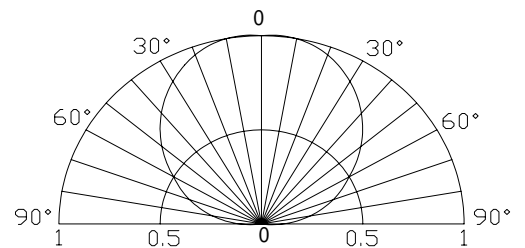

**Electrical -Optical Characteristics**

(Ta=25 )

Part Number	Color		V <sub>F</sub> (V)			I <sub>R</sub> (μA)	I <sub>v</sub> (mcd)			CCT			2θ1/2(deg)
			Min.	Typ.	Max.	Max.	Min.	Typ.	Max.	Min.	Typ.	Max.	Typ.
			I <sub>F</sub> =60mA			V <sub>R</sub> =5V	I <sub>F</sub> =60mA						
OSW35630C1A-60mA	White	W	2.9	3.1	3.6	10	7300	-	8500	5000K	-	6000K	120
OSM55630C1A-60mA	Warm White	M	2.9	3.1	3.6	10	5100	-	7300	2800K	-	3500K	120

Note: \* V<sub>f</sub> tolerance: ±0.05V

\* Luminous flux measurement allowance is:±10%

**Rank**

**\* Correspondence Table of Luminous Flux – Intensity**

Rank	Luminous Intensity (mcd)	Luminous Flux (lm)*
H11	5100-5440	15.0-16.0
H12	5440-5780	16.0-17.0
H21	5780-6290	17.0-18.5
H22	6290-6800	18.5-20.0
I11	6800-7310	20.0-21.5
I12	7310-7820	21.5-23.0
I21	7820-8500	23.0-25.0
I22	8500-9180	25.0-27.0

**Chromaticity Diagram**

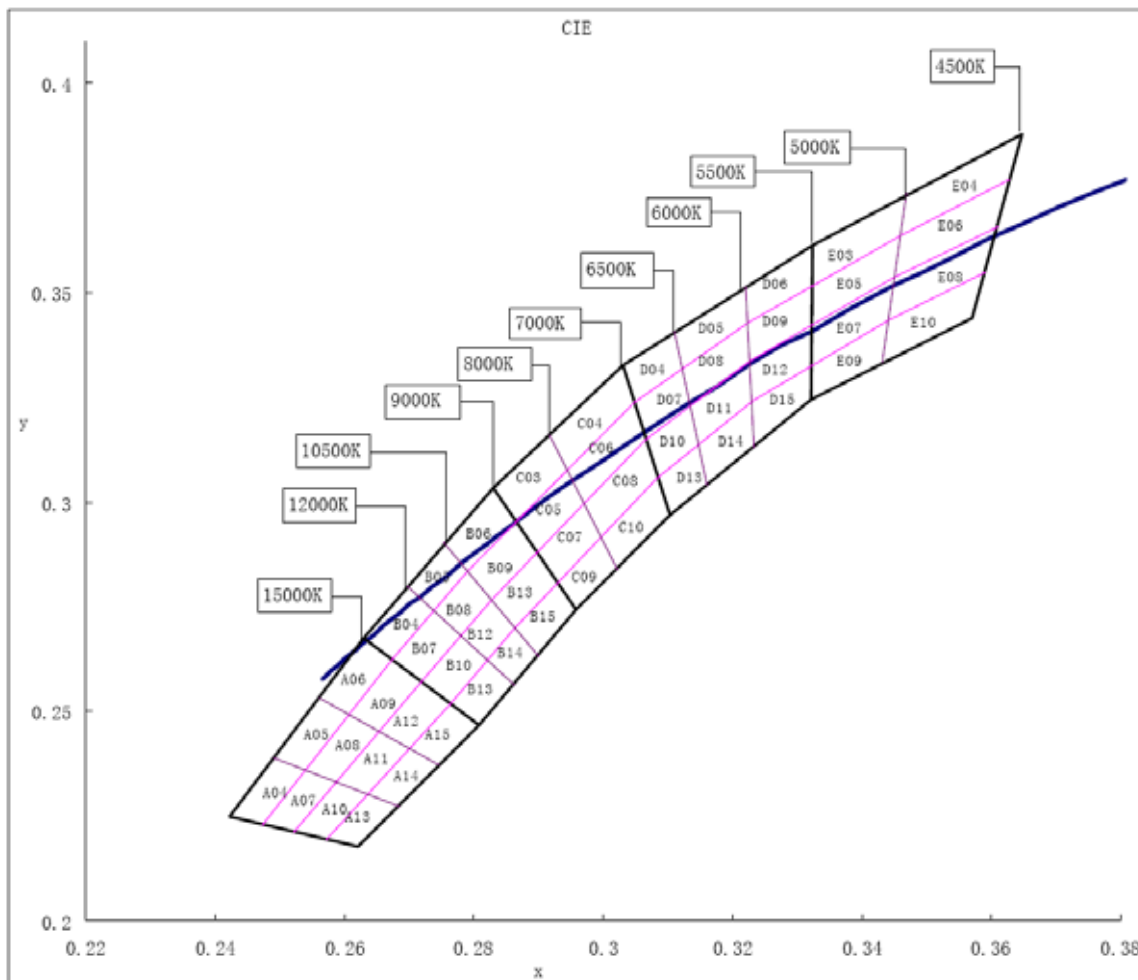

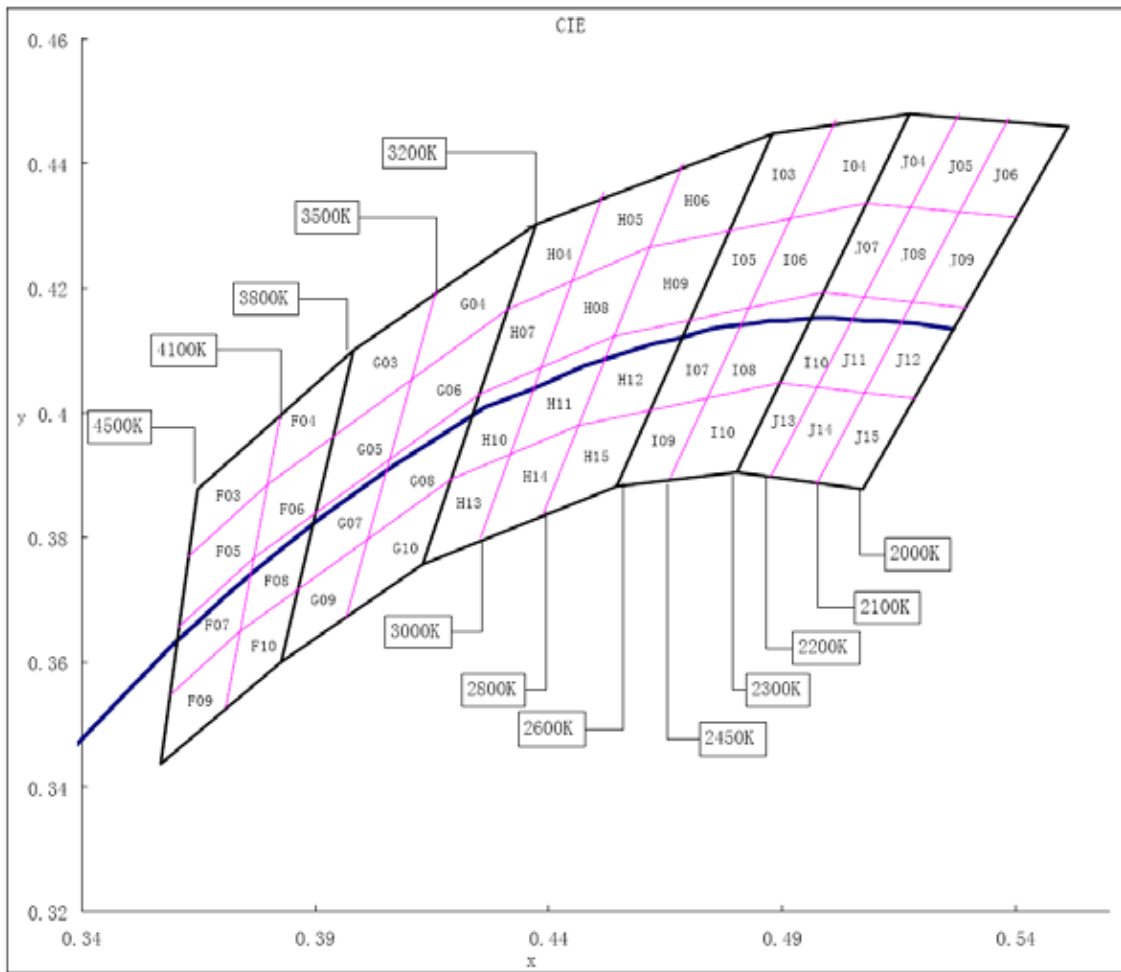

**\*Bin Range of Chromaticity Coordinates (OSW35630C1A)**

Code	X1	Y1	X2	Y2	X3	Y3	X4	Y4
D06	0.3221	0.3523	0.3324	0.3612	0.3324	0.3520	0.3224	0.3420
D09	0.3224	0.3430	0.3324	0.3520	0.3323	0.3429	0.3228	0.3336
D12	0.3228	0.3336	0.3323	0.3429	0.3323	0.3337	0.3231	0.3243
D15	0.3231	0.3243	0.3323	0.3337	0.3322	0.3245	0.3234	0.3149
E03	0.3324	0.3612	0.3470	0.3738	0.3461	0.3637	0.3324	0.3520
E05	0.3324	0.3520	0.3461	0.3637	0.3452	0.3536	0.3323	0.3429
E07	0.3323	0.3429	0.3452	0.3536	0.3442	0.3435	0.3323	0.3337
E09	0.3323	0.3337	0.3442	0.3435	0.3433	0.3334	0.3322	0.3245

**\*Bin Range of Chromaticity Coordinates (OSM55630C1A)**

Code	X1	Y1	X2	Y2	X3	Y3	X4	Y4
G04	0.4160	0.4199	0.4373	0.4302	0.4313	0.4166	0.4112	0.4067
G06	0.4112	0.4067	0.4313	0.4166	0.4252	0.4030	0.4063	0.3936
G08	0.4063	0.3936	0.4252	0.4030	0.4192	0.3893	0.4015	0.3804
G10	0.4015	0.3804	0.4192	0.3893	0.4131	0.3757	0.3966	0.3672
H04	0.4373	0.4302	0.4518	0.4354	0.4453	0.4216	0.4313	0.4166
H05	0.4518	0.4354	0.4689	0.4408	0.4614	0.4265	0.4453	0.4216
H07	0.4313	0.4166	0.4453	0.4216	0.4387	0.4077	0.4252	0.4030
H08	0.4453	0.4216	0.4614	0.4265	0.4539	0.4123	0.4387	0.4077
H10	0.4252	0.4030	0.4387	0.4077	0.4322	0.3939	0.4192	0.3893
H11	0.4387	0.4077	0.4539	0.4123	0.4463	0.3980	0.4322	0.3939
H13	0.4192	0.3893	0.4322	0.3939	0.4256	0.3800	0.4131	0.3757
H14	0.4322	0.3939	0.4463	0.3980	0.4388	0.3837	0.4256	0.3800

\*If color binning is required, only one color group is allowed for each chip within a reel.

Chromaticity coordinate groups are measured with an accuracy of  $\pm 0.01$

\*Color coordinate is derived from the CIE 1931 chromaticity.

**\*Bin rank of VF**

Rank ( $I_F=20mA$ )	White		
	88T-999	AAA	BBB
DC Forward Voltage(v)	2.9-3.2	3.2-3.4	3.4-3.6

\*Forward voltage is measured with an accuracy of  $\pm 0.1V$ .

Typical Electro-Optical Characteristics Curves

Spectrum

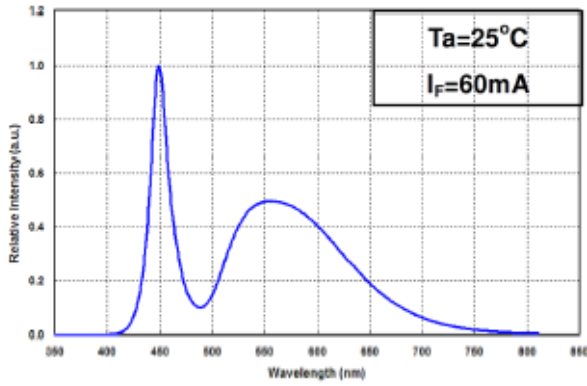

Luminous Intensity —  $I_f$

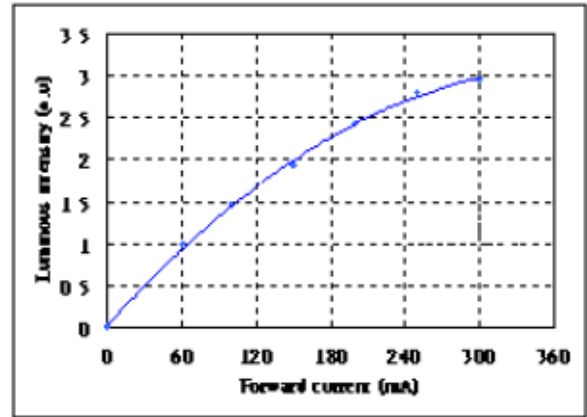

$I_f - V_f$

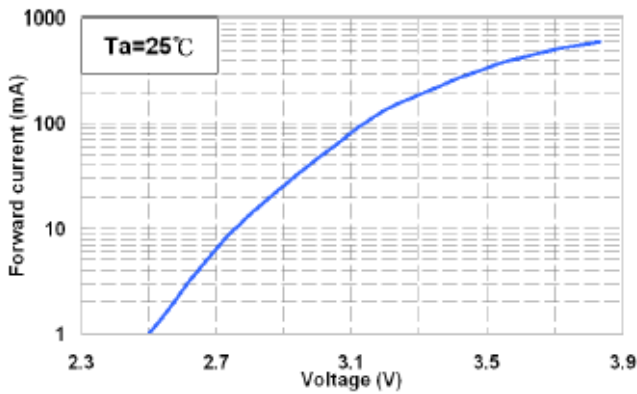

Radiation Pattern

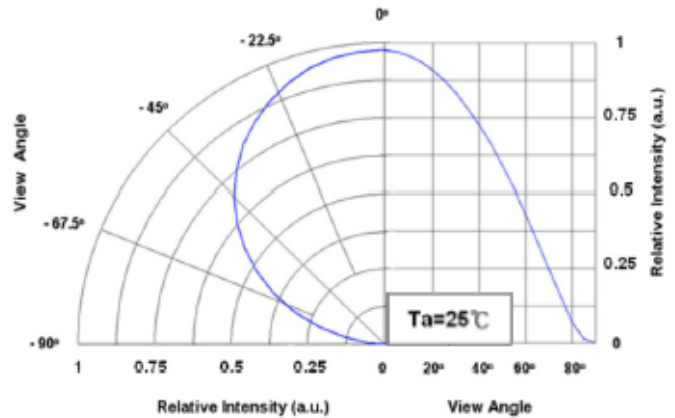

## RELIABILITY TEST REPORT

CLASSIFICATION	TEST TIME	TEST CONDITON
ENDURANCE TEST	OPERATION LIFE	If:60mA Ta:25+5 TEST ITME=1000HRS(-24HRS,+72HRS)
	HIGH TEMPERTURE HIGH HUMIDITY STORAGE	R.H:90~95% Ta:65+5 TEST ITME=240HRS(+2HRS)
	HIGH TEMPERTURE STORAGE	Ta:105±5 TEST ITME=500HRS(-24HRS,+48HRS)
	LOW TEMPERTURE STORAGE	Ta:-55±5 TEST ITME=500HRS(-24HRS,+48HRS)
ENVIRONMENTAL TEST	TEMPERTURE CYCLING	105 ~25 ~-55 ~25 60min 10min 60min 10min 20cycles
	THERMAL SHOCK	105 ~-55 10min 10min 10cycles
	SOLDER RESISTANCE	Ta:260±5 TEST ITME=10±1sec
	SOLDERABILITY	Ta:230±5 TEST ITME=5±1sec

### JUDGMENT CRITERIA OF FAILURE FOR THE RELIABILITY

MEASURING ITME	SYMBOL	CONDITIONS	FAILUER
LUMINOUS INTENSITY	IV	IF=60mA	IV<0.5*INITIAL VALUE
FORWARD VOLTAGE	VF	IF=60mA	VF>1.2*INITIAL VALUE
REVERSE CURRENT	IR	Vr=5V	IR>2*SPEC

**Recommended Reflow Soldering Profile**

**Surface mounting condition**

In automatic mounting of the SMD LEDs on printed circuit boards, any bending, expanding and pulling forces or shock against the SMD LEDs should be kept min. to prevent them from electrical failures and mechanical damages of the devices.

**Soldering reflow**

- Soldering of the SMD LEDs should conform to the soldering condition in the individual specifications.
- SMD LEDs are designed for reflow soldering.
- In the reflow soldering, too high temperature and too large temperature gradient such as rapid heating/cooling may cause electrical & optical failures and damages of the devices.
- Wellypower can't guarantee the LEDs after they have been assembled using the solder dipping method.

**1) Lead solder**

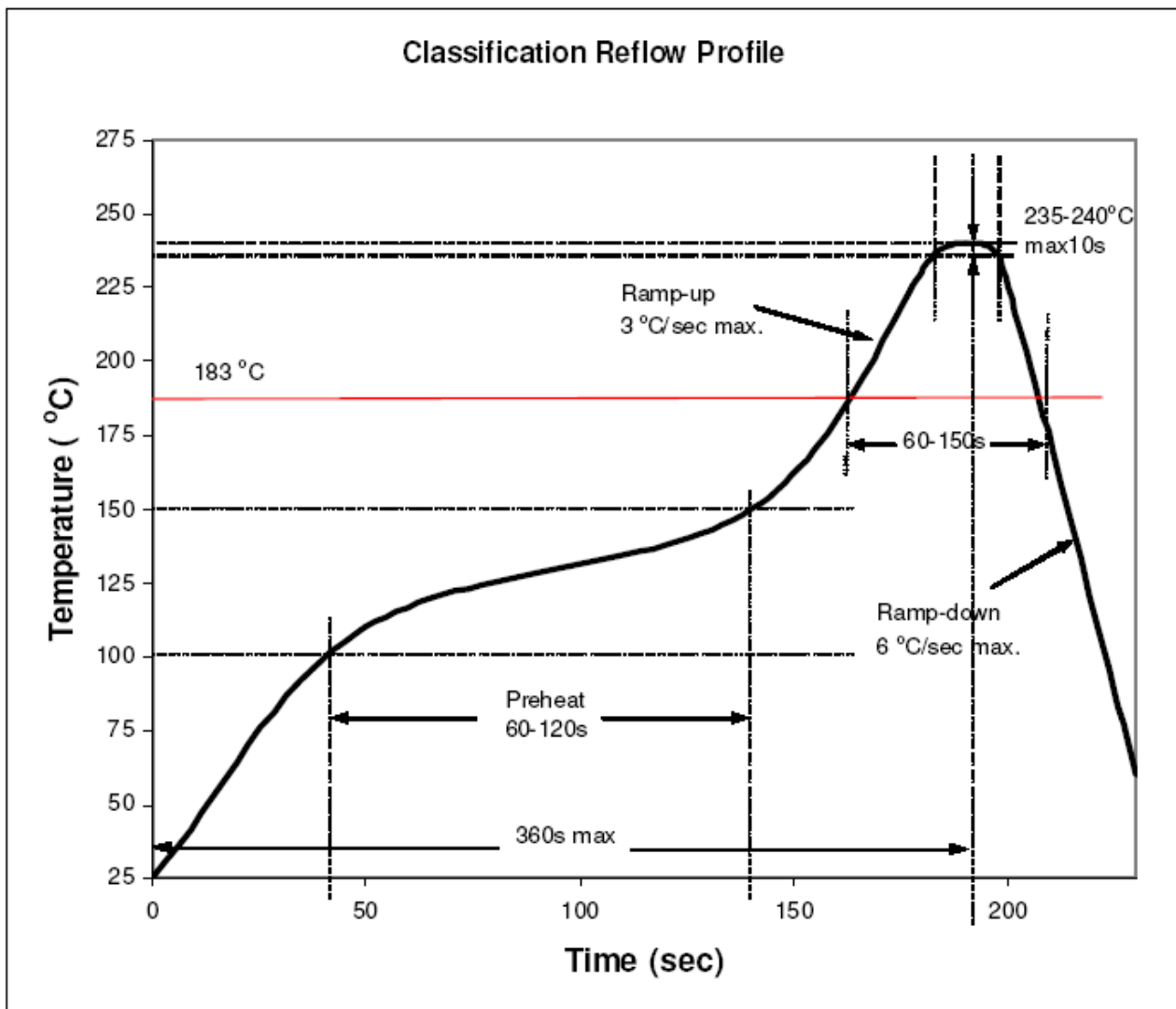

## 2) Lead-free solder

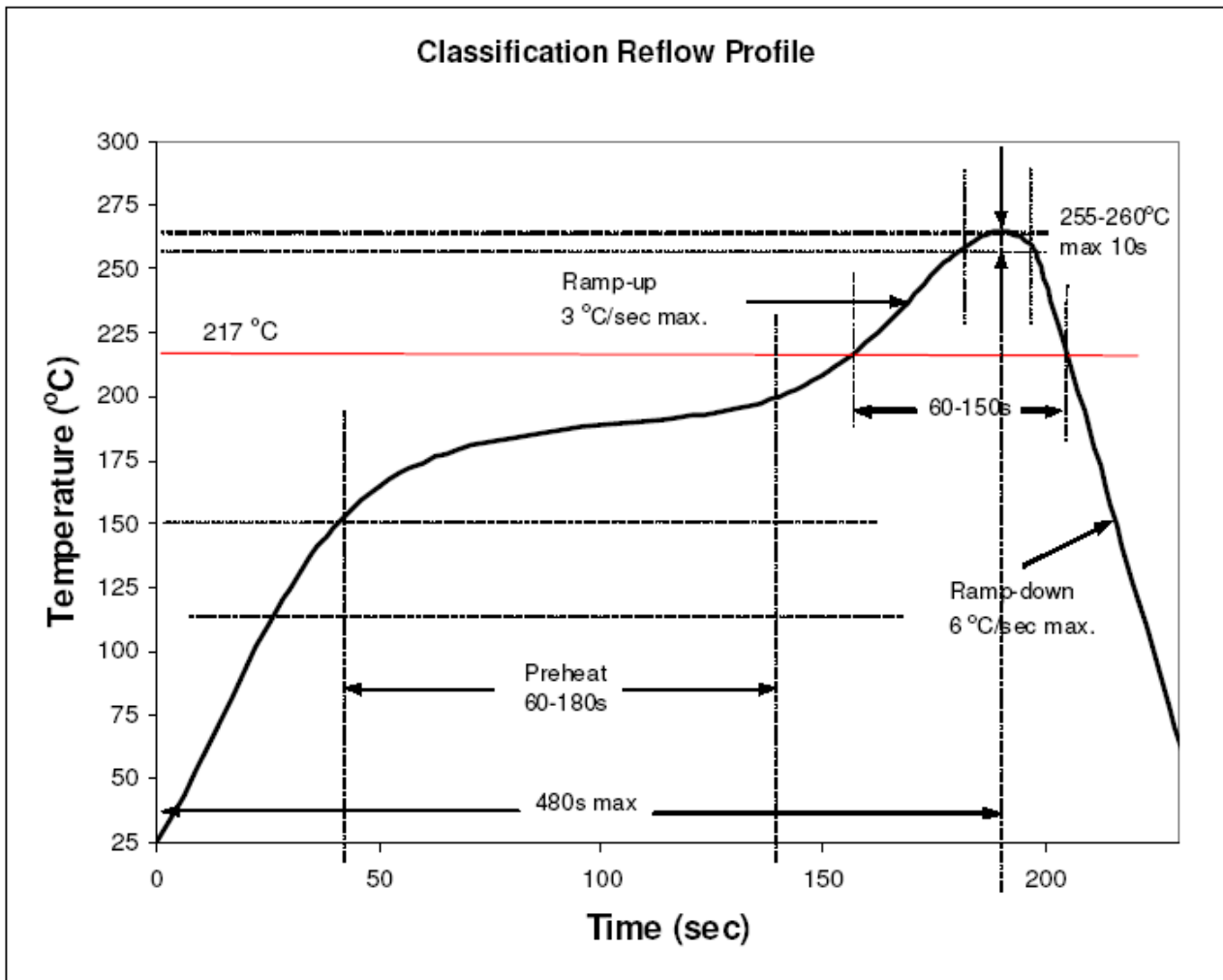

## 3) Manual soldering.

- Lead solder  
Max. 300 for max. 3sec, and only one time.
- Lead-free solder  
Max. 350 for max. 3sec, and only one time.
- There is possibility that the brightness of LEDs is decreased, which is influenced by heat or ambient atmosphere during reflow. It is recommended to use the nitrogen reflow method use the nitrogen reflow method.
- After LEDs have been soldered, repairs should not be done. As repair is unavoidable, a doublehead soldering iron should be used. It should be confirmed beforehand whether the characteristics of the LEDs will be damaged by repairing or not.
- Reflow soldering should not be done more than two times.



Package Model  
Loaded Quantity 4000 pcs. Per Reel

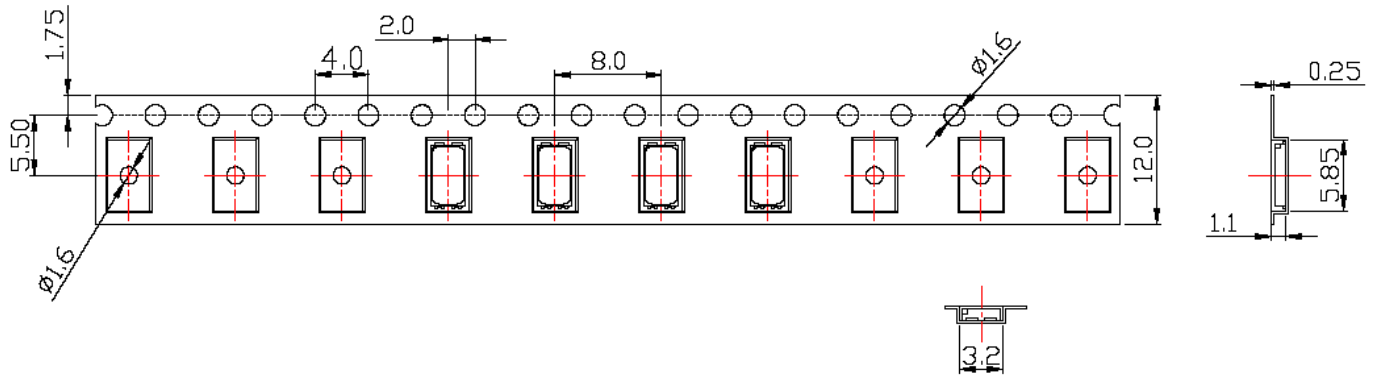

Reel Part

