

JOYSTICK ENCODER

CJ25

FEATURES

- Multi-function device ... Joystick, optical encoder, and push switch functions in one package.
- Suitable size for panels. Smooth operational feel.
- Long life ... Joystick 500K cycles, encoder & switch 1M cycles
- RoHS compliant



APPLICATIONS

Operation panels for;

- Medical device
- Broadcast equipment
- Surveillance camera etc.

PART NUMBER DESIGNATION

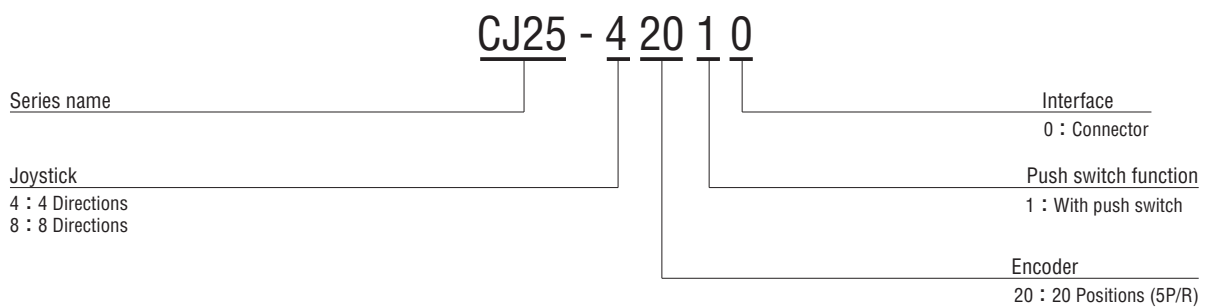

LIST OF PART NUMBERS

Part number	Joystick	Encoder	Push switch function	Interface
CJ25-42010	4 directions	20 Positions(5P/R)	With push switch	Connector
CJ25-82010	8 directions			

CJ25

JOYSTICK ENCODER

STANDARD SPECIFICATIONS

Electrical characteristics

Encoder

Input voltage	DC5 V \pm 5 %
Input current	20mA maximum at 5V
Output wave form	Incremental signal (Square wave)
Pulses Per Rotation	5P/R
Maximum frequencies response	10Hz
Output	Open collector, Pull-up resistor 2.2K Ω
Output Code	2-Bit, Channel A/B, Phase difference 90°
Output Signal	High : 3.8V minimum Low : 0.4V maximum
Output Sink Current	6mA minimum

Joystick

Input current	5mA maximum at 5V
Output Code	2-Bit (X,Y)
Output Signal	Neutral : 2.5 \pm 0.5V High : 4.5V minimum Low : 0.5V maximum

Switch

Rating	DC5V, 10mA
Contact Resistance	10 Ω maximum
Contact Bouncing	Switching : 4ms make Non-switching : 10ms break

Mechanical characteristics

Mounting Torque	1.17N · m maximum (12kgf · cm maximum)
Actuator Strength	19.6N maximum (2kg maximum)
Max. Shaft Pull-out Strength	98N maximum (10kg maximum)
Max. Shaft Push-out Strength	98N maximum (10kg maximum)

Encoder

Click Torque	9.8 \pm 4.9mN · m (100 \pm 50gf · cm)
Clicks Per Rotation	20
Rotational Life	1 million cycles

Joystick

Angle of Throw	All directions 9 \pm 2°
Operating Force	X,Y 1.47 \pm 0.74N (150 \pm 75gf)
Joystick Life	500,000 actuation each in directions (X, Y)

Switch

Operating Force	3.43 \pm 1.47N (350 \pm 150gf)
Stroke	0.5 \pm 0.2mm
Switching Life	1 million cycles

Environmental characteristics

Operating Temp. Range	0°C ~ + 50°C
Storage Temp. Range	-20 ~ 80°C

RELIABILITY TEST

Test item		Test conditions
Vibration	Power OFF	Amplitude : 1.52mm or 98.1m/s ² (10G) whichever is smaller. 10 ~ 500Hz excursion 15 min/cycle, 8 cycles each for X, Z, directions.
Shock	Power OFF	3 times each in directions (X, Z) at 490m/s ² (50G), 11ms.
High temperature exposure	Power OFF	80 °C 96 h
	Power ON	50 °C 96 h
Low temperature exposure	Power OFF	- 20 °C 96 h
	Power ON	0 °C 96 h
Humidity	Power OFF	40 °C Relative humidity 90 ~ 95 % 96 h (To be measured after wiping out moisture and leaving samples for 1 h at normal temperature and humidity after the test.)
Thermal shock	Power OFF	To be done 10 cycles with the following condition (To be measured after leaving samples for 1 h at normal temperature and humidity after the test.) 80 °C 0.5 h、- 20 °C 0.5 h

CJ25 JOYSTICK ENCODER

OUTLINE DIMENSIONS

PIN ASSIGNMENT

Pin No.	Function
1	Joystick "X"
2	Joystick "Y"
3	Power "+5V"
4	Output "A"
5	Output "B"
6	Switch
7	Switch
8	GND

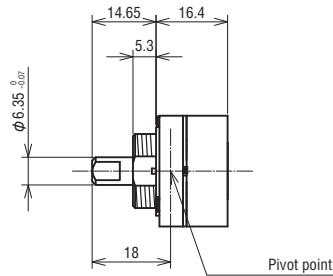

Unless otherwise specified, tolerance: ± 0.4 (Unit: mm)

<Accessories>

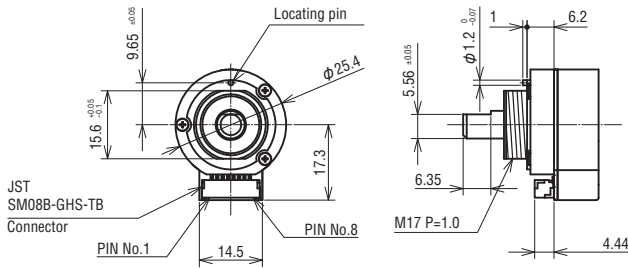
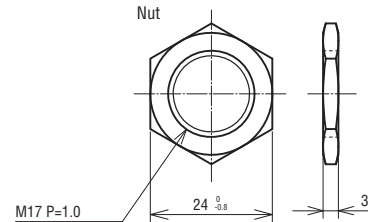

<Panel cut-out dimensions>

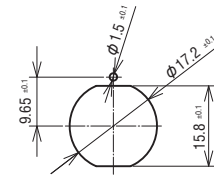

OUTPUT

JOYSTICK

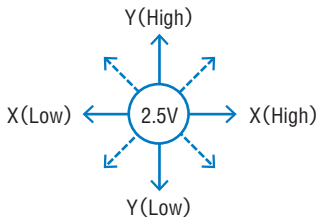

"Y (High)" defined by locating pin.

ENCODER Output Waveform

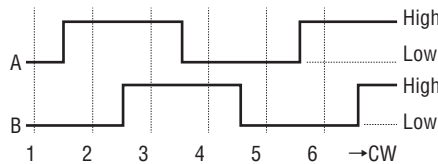

Position number: 1~6... (Clockwise rotation)

Position	Output	A	B
1			
2		●	
3		●	●
4			●

● = High
blank = Low

※ Code repeats every 4 positions.

SWITCH

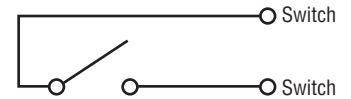

OPTION

(Wire harnesses)

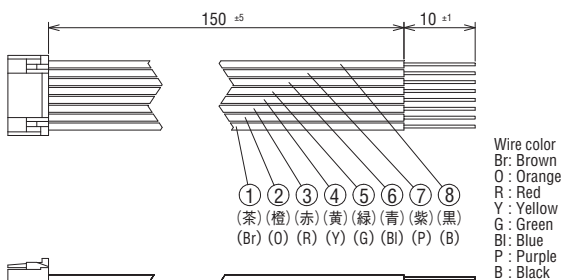

Optional wire harnesses are available upon request.

OUTPUT CIRCUITRY AND RECEIVING CIRCUITRY

