

**PLEASE CHECK WWW.MOLEX.COM FOR LATEST PART INFORMATION**

**Part Number:** [0781191118](#)  
**Status:** **Active**  
**Overview:** ffc fpc smt  
**Description:** 0.50mm (.020") Pitch FFC/FPC Connector, SMT, Non ZIF, Vertical, Gold Plating, 11 Circuits, Lead Free

**Documents:**

[3D Model](#) [Product Specification PS-78119-001 \(PDF\)](#)  
[Drawing \(PDF\)](#) [RoHS Certificate of Compliance \(PDF\)](#)

**Agency Certification**

CSA LR19980  
 UL E29179

**General**

Product Family FFC/FPC Connectors  
 Series [78119](#)  
 Overview [ffc fpc smt](#)  
 Product Name N/A

**Physical**

Circuits (Loaded) 11  
 Color - Resin Natural  
 Contact Position N/A  
 Durability (mating cycles max) 20  
 Entry Angle Vertical  
 Flammability 94V-0  
 Mated Height (in) 0.161 In  
 Mated Height (mm) 4.10 mm  
 Material - Metal Copper Alloy  
 Material - Plating Mating Gold, Nickel  
 Number of Rows 1  
 Orientation Vertical  
 PCB Locator No  
 PCB Retention None  
 Packaging Type Embossed Tape on Reel  
 Pitch - Mating Interface (in) 0.020 In  
 Pitch - Mating Interface (mm) 0.50 mm  
 Pitch - Term. Interface (in) 0.020 In  
 Pitch - Term. Interface (mm) 0.50 mm  
 Polarized to PCB No  
 Stackable No  
 Temperature Range - Operating -40°C to +85°C  
 Termination Interface: Style Surface Mount  
 Wire/Cable Type FFC/FPC

**Electrical**

Current - Maximum per Contact 0.5A  
 Voltage - Maximum 50V AC

**Material Info**

**Reference - Drawing Numbers**

Package Specification SPK-78119-001  
 Product Specification PS-78119-001  
 Sales Drawing SD-78119-001

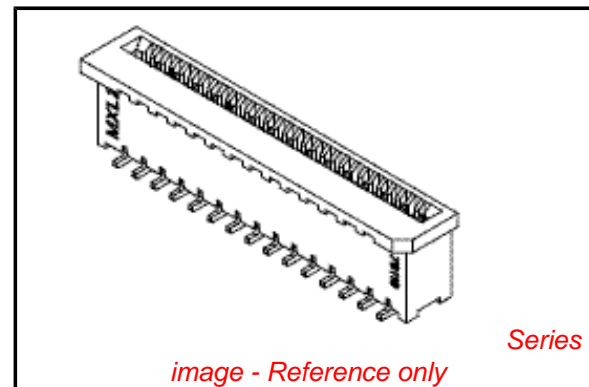

*image - Reference only*

**EU RoHS**

**ELV and RoHS  
 Compliant**  
**REACH SVHC  
 Contains SVHC: No**  
**Halogen-Free  
 Status  
 Not Reviewed**

**China RoHS**



**Need more information on product  
 environmental compliance?**

Email [productcompliance@molex.com](mailto:productcompliance@molex.com)  
 For a multiple part number RoHS Certificate of  
 Compliance, [click here](#)

Please visit the [Contact Us](#) section for any  
 non-product compliance questions.

**Search Parts in this Series**

[78119Series](#)

**Mates With**

[Standard FFC/FPC Cables](#)

This document was generated on 06/07/2010

**PLEASE CHECK [WWW.MOLEX.COM](http://WWW.MOLEX.COM) FOR LATEST PART INFORMATION**

10 9 8 7 6 5 4 3 2 1

F

E

D

C

B

A

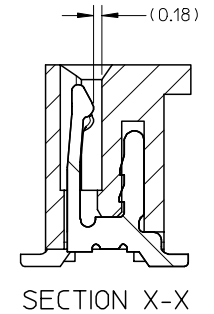
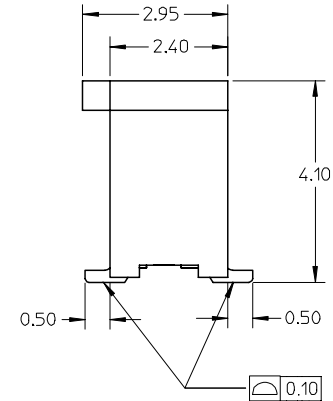
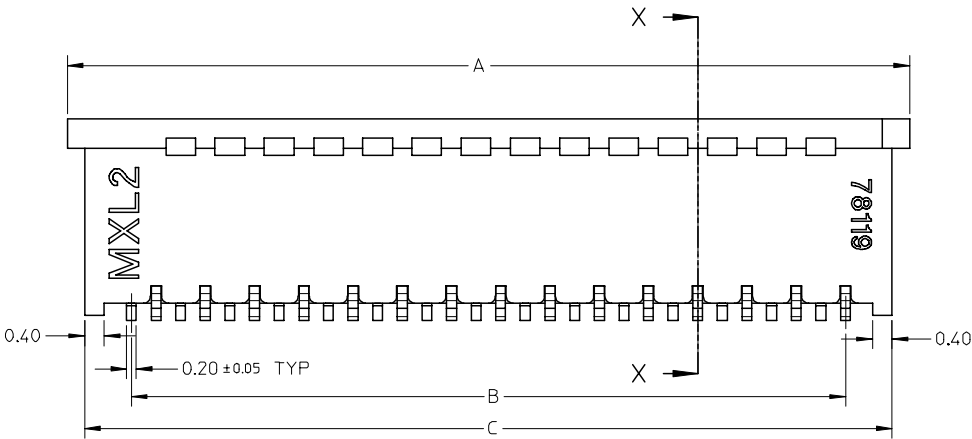
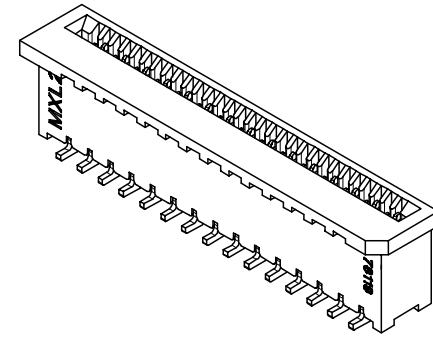
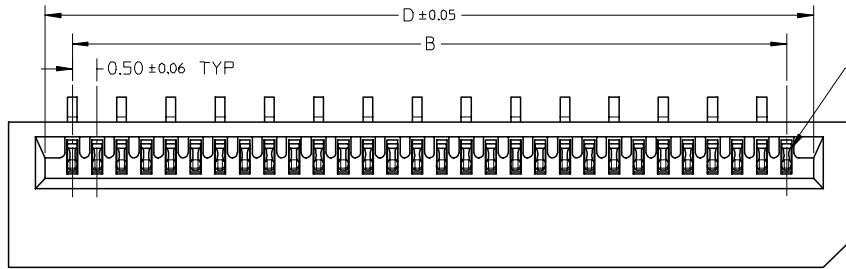

NOTE:

1. MATERIAL:  
HOUSING: PA46 GLASS FILLED, UL94V-0, COLOR: NATURAL  
TERMINAL: COPPER ALLOY
2. PLATING: 1) 0.10 μm MIN. GOLD PLATING OVER NICKEL PLATING OVERALL  
2) 1-3 μm TIN-BISMUTH OVER NICKEL PLATING OVERALL
3. PRODUCT SPECIFICATION: PS-78119-001
4. PRODUCT ARE PACKED IN TAPE & REEL.

REVISED	DESCRIPTION
EC NO: S2007-0721	2007/03/05
DRWN: BOKOK	2007/03/05
CHKD: CGOH	2007/03/05
APPR: KCLING	2007/03/05
A2	REV

QUALITY SYMBOLS	▽=0
	∇=0

GENERAL TOLERANCES (UNLESS SPECIFIED)	
	mm
	INCH
4 PLACES	± ---
3 PLACES	± ---
2 PLACES	± 0.15
1 PLACE	± ---
ANGULAR ± 3°	
DRAFT WHERE APPLICABLE MUST REMAIN WITHIN DIMENSIONS	

DIMENSION STYLE	
MM ONLY	
DRAWN BY	DATE
YLQ1A0	2006/04/11
CHECKED BY	DATE
BOKOK	2006/04/18
APPROVED BY	DATE
PTL IM	2006/04/18
MATERIAL NO.	
SEE TABLE	
SIZE	A3

SCALE	DESIGN UNITS	THIRD ANGLE PROJECTION
NTS	METRIC	
TITLE		
0.50MM PITCH, FPC CONN. NON-ZIF, SMT		
MOLEX INCORPORATED		
DOCUMENT NO.	SHEET NO.	
SD-78119-001	1 OF 7	

9 8 7 6 5 4 3 2 1

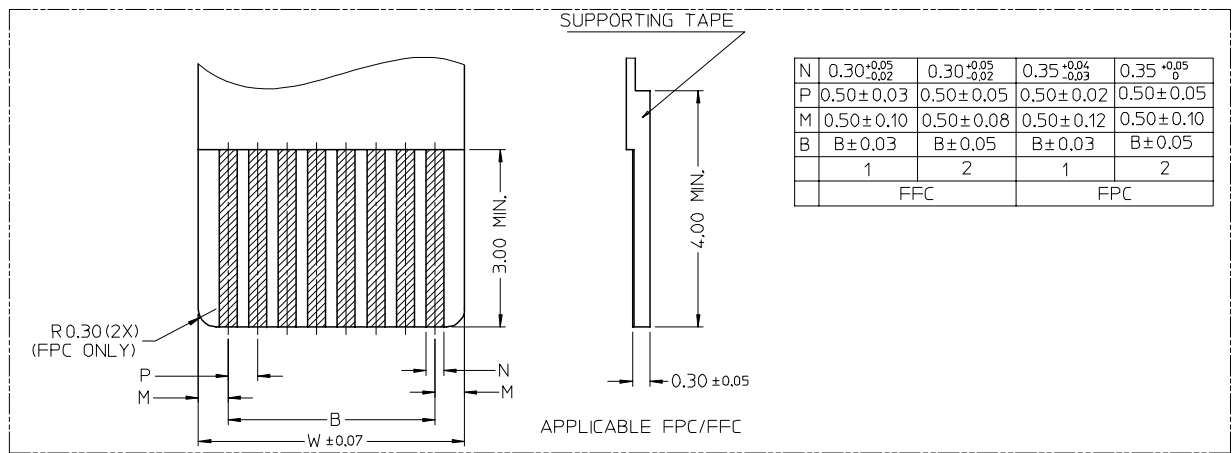
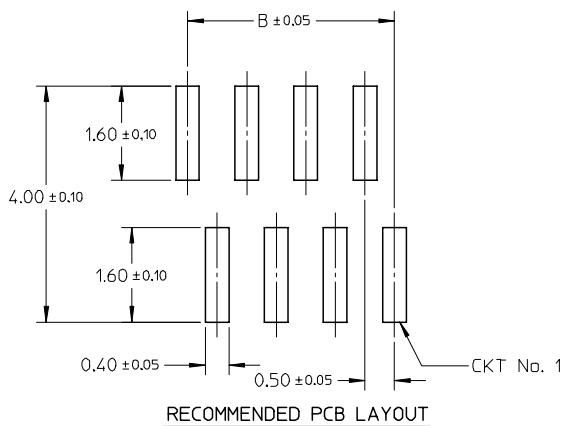

REVISED EC NO: S2007-0721 DRWN: BOKOK CHKD: CGOH APPR: KCLING	2007/03/05 2007/03/05 2007/03/05	QUALITY SYMBOLS ▽=0 ▽=0	GENERAL TOLERANCES (UNLESS SPECIFIED)		DIMENSION STYLE MM ONLY		SCALE NTS	DESIGN UNITS METRIC	THIRD ANGLE PROJECTION			
			4 PLACES ± --- ± --- 3 PLACES ± --- ± --- 2 PLACES ± 0.15 ± --- 1 PLACE ± --- ± ---	mm INCH	DRAWN BY YLQ1A0	DATE 2006/04/11	TITLE 0.50MM PITCH, FPC CONN. NON-ZIF, SMT					
			ANGULAR ± 3 °			CHECKED BY BOKOK	DATE 2006/04/18	MOLEX INCORPORATED				
			DRAFT WHERE APPLICABLE MUST REMAIN WITHIN DIMENSIONS			APPROVED BY PTLIM	DATE 2006/04/18	MATERIAL NO. SEE TABLE	DOCUMENT NO. SD-78119-001	SHEET NO. 2 OF 7		

GOLD PLATING TERMINAL ASSEMBLY PART NUMBERS

ASSY P/N W/O PACKAGING	CKT	DIM A	DIM B	DIM C	DIM D	PLATING TYPE
78119-0068	6	5.10	2.50	4.40	3.60	1
78119-0078	7	5.60	3.00	4.90	4.10	
78119-0088	8	6.10	3.50	5.40	4.60	
78119-0098	9	6.60	4.00	5.90	5.10	
78119-0108	10	7.10	4.50	6.40	5.60	
78119-0118	11	7.60	5.00	6.90	6.10	
78119-0128	12	8.10	5.50	7.40	6.60	
78119-0138	13	8.60	6.00	7.90	7.10	
78119-0148	14	9.10	6.50	8.40	7.60	
78119-0158	15	9.60	7.00	8.90	8.10	
78119-0168	16	10.10	7.50	9.40	8.60	
78119-0178	17	10.60	8.00	9.90	9.10	
78119-0188	18	11.10	8.50	10.40	9.60	
78119-0198	19	11.60	9.00	10.90	10.10	
78119-0208	20	12.10	9.50	11.40	10.60	
78119-0218	21	12.60	10.00	11.90	11.10	
78119-0228	22	13.10	10.50	12.40	11.60	
78119-0238	23	13.60	11.00	12.90	12.10	
78119-0248	24	14.10	11.50	13.40	12.60	
78119-0258	25	14.60	12.00	13.90	13.10	
78119-0268	26	15.10	12.50	14.40	13.60	
78119-0278	27	15.60	13.00	14.90	14.10	
78119-0288	28	16.10	13.50	15.40	14.60	
78119-0298	29	16.60	14.00	15.90	15.10	
78119-0308	30	17.10	14.50	16.40	15.60	

ASSY P/N W/O PACKAGING	CKT	DIM A	DIM B	DIM C	DIM D	PLATING TYPE
78119-0318	31	17.60	15.00	16.90	16.10	1
78119-0328	32	18.10	15.50	17.40	16.60	
78119-0338	33	18.60	16.00	17.90	17.10	
78119-0348	34	19.10	16.50	18.40	17.60	
78119-0358	35	19.60	17.00	18.90	18.10	
78119-0368	36	20.10	17.50	19.40	18.60	
78119-0378	37	20.60	18.00	19.90	19.10	
78119-0388	38	21.10	18.50	20.40	19.60	
78119-0398	39	21.60	19.00	20.90	20.10	
78119-0408	40	22.10	19.50	21.40	20.60	
78119-0418	41	22.60	20.00	21.90	21.10	
78119-0428	42	23.10	20.50	22.40	21.60	

REVISED EC NO: S2007-0721 DRWN: BOKOK CHKD: CGOH APPR: KCLING 2007/03/05 2007/03/05 2007/03/05	QUALITY SYMBOLS ▽=0 ▽=0	GENERAL TOLERANCES (UNLESS SPECIFIED)		DIMENSION STYLE MM ONLY		SCALE NTS	DESIGN UNITS METRIC	THIRD ANGLE PROJECTION			
		4 PLACES ± --- ± ---	3 PLACES ± --- ± ---	2 PLACES ± 0.15 ± ---	1 PLACE ± --- ± ---	ANGULAR ± 3 °	DRAWN BY YLQIAO	DATE 2006/04/11	TITLE 0.50MM PITCH, FPC CONN. NON-ZIF, SMT		
		DRAFT WHERE APPLICABLE MUST REMAIN WITHIN DIMENSIONS					CHECKED BY BOKOK	DATE 2006/04/18	MOLEX INCORPORATED		
		SEE TABLE					APPROVED BY PTLIM	DATE 2006/04/18	DOCUMENT NO. SD-78119-001	SHEET NO. 3 OF 7	

10 9 8 7 6 5 4 3 2 1

F

F

TIN-BISMUTH PLATING TERMINAL ASSEMBLY PART NUMBERS

ASSY P/N W/O PACKAGING	CKT	DIM A	DIM B	DIM C	DIM D	PLATING TYPE
78119-0069	6	5.10	2.50	4.40	3.60	2
78119-0079	7	5.60	3.00	4.90	4.10	
78119-0089	8	6.10	3.50	5.40	4.60	
78119-0099	9	6.60	4.00	5.90	5.10	
78119-0109	10	7.10	4.50	6.40	5.60	
78119-0119	11	7.60	5.00	6.90	6.10	
78119-0129	12	8.10	5.50	7.40	6.60	
78119-0139	13	8.60	6.00	7.90	7.10	
78119-0149	14	9.10	6.50	8.40	7.60	
78119-0159	15	9.60	7.00	8.90	8.10	
78119-0169	16	10.10	7.50	9.40	8.60	
78119-0179	17	10.60	8.00	9.90	9.10	
78119-0189	18	11.10	8.50	10.40	9.60	
78119-0199	19	11.60	9.00	10.90	10.10	
78119-0209	20	12.10	9.50	11.40	10.60	
78119-0219	21	12.60	10.00	11.90	11.10	
78119-0229	22	13.10	10.50	12.40	11.60	
78119-0239	23	13.60	11.00	12.90	12.10	
78119-0249	24	14.10	11.50	13.40	12.60	
78119-0259	25	14.60	12.00	13.90	13.10	
78119-0269	26	15.10	12.50	14.40	13.60	
78119-0279	27	15.60	13.00	14.90	14.10	
78119-0289	28	16.10	13.50	15.40	14.60	
78119-0299	29	16.60	14.00	15.90	15.10	
78119-0309	30	17.10	14.50	16.40	15.60	

ASSY P/N W/O PACKAGING	CKT	DIM A	DIM B	DIM C	DIM D	PLATING TYPE
78119-0319	31	17.60	15.00	16.90	16.10	2
78119-0329	32	18.10	15.50	17.40	16.60	
78119-0339	33	18.60	16.00	17.90	17.10	
78119-0349	34	19.10	16.50	18.40	17.60	
78119-0359	35	19.60	17.00	18.90	18.10	
78119-0369	36	20.10	17.50	19.40	18.60	
78119-0379	37	20.60	18.00	19.90	19.10	
78119-0389	38	21.10	18.50	20.40	19.60	
78119-0399	39	21.60	19.00	20.90	20.10	
78119-0409	40	22.10	19.50	21.40	20.60	
78119-0419	41	22.60	20.00	21.90	21.10	
78119-0429	42	23.10	20.50	22.40	21.60	

E

E

D

D

C

C

B

B

A

A

REVISED EC NO: S2007-0721 DRWN: BOKOK CHKD: CGOH APPR: KCLING 2007/03/05 2007/03/05 2007/03/05 2007/03/05	QUALITY SYMBOLS	GENERAL TOLERANCES (UNLESS SPECIFIED)	DIMENSION STYLE	SCALE	DESIGN UNITS	THIRD ANGLE PROJECTION	
	$\nabla = 0$ $\nabla \text{C} = 0$	mm INCH 4 PLACES ± --- ± --- 3 PLACES ± --- ± --- 2 PLACES ± 0.15 ± --- 1 PLACE ± --- ± --- ANGULAR ± 3 °	MM ONLY	NTS	METRIC	YLQ1A0 DATE 2006/04/11 CHECKED BY DATE BOKOK 2006/04/18 APPROVED BY DATE PTL IM 2006/04/18	0.50MM PITCH, FPC CONN. NON-ZIF, SMT
		DRAFT WHERE APPLICABLE MUST REMAIN WITHIN DIMENSIONS	SEE TABLE			MOLEX INCORPORATED SD-78119-001	SHEET NO. 4 OF 7
	A2			SIZE A3	THIS DRAWING CONTAINS INFORMATION THAT IS PROPRIETARY TO MOLEX INCORPORATED AND SHOULD NOT BE USED WITHOUT WRITTEN PERMISSION		

9 8 7 6 5 4 3 2 1

10 9 8 7 6 5 4 3 2 1

F  
E  
D  
C  
B  
A

F  
E  
D  
C  
B  
A

EMBOSSED TYPE A

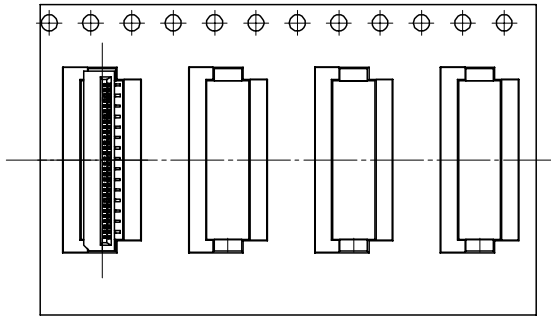

CUSTOMER  
PULL OUT DIRECTION

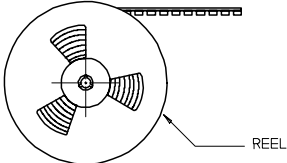

REEL

NOTES:

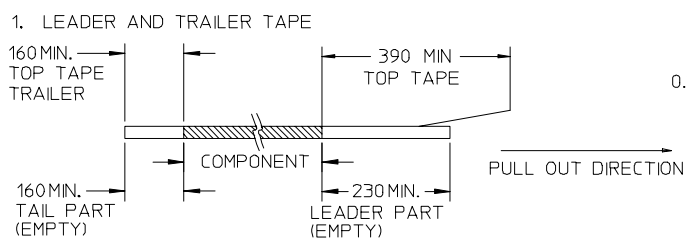

2. PEELING OFF FORCE OF THE TOP TAPE: 20-80gf.  
(PEELING DIRECTION AS SHOWN IN FOLLOWING FIGURE)

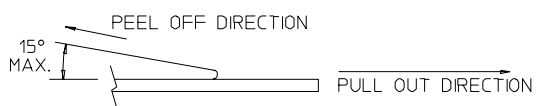

3. PACKAGING STANDARD IS AS PER EIA-481.  
4. TAPE & REEL QUANTITY = 1000 PCS/REEL

EMBOSSED TYPE B

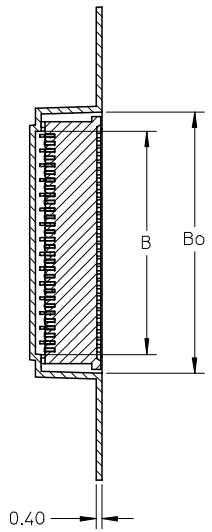
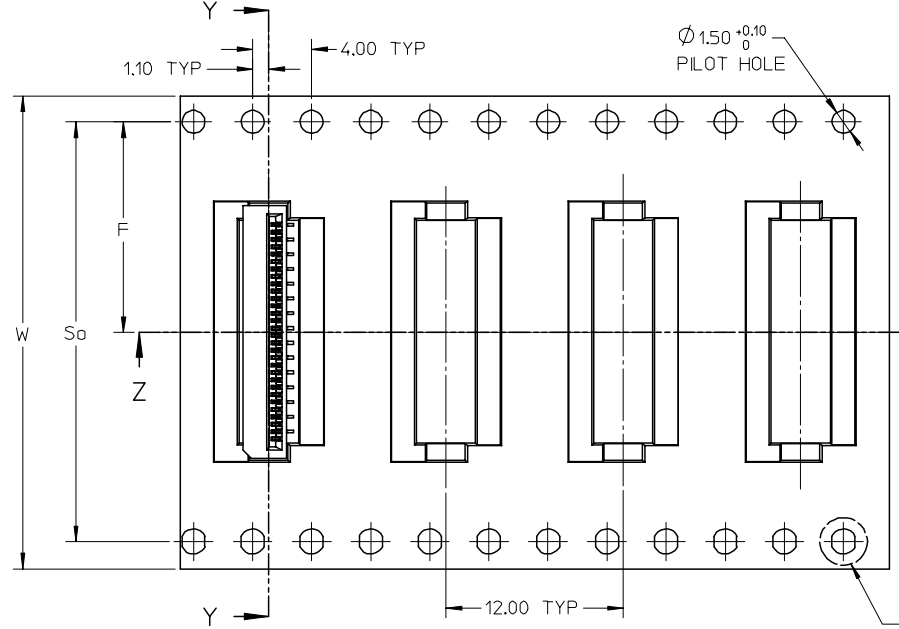

SECTION Y-Y

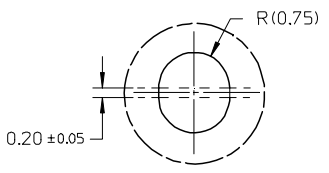

DETAIL 1

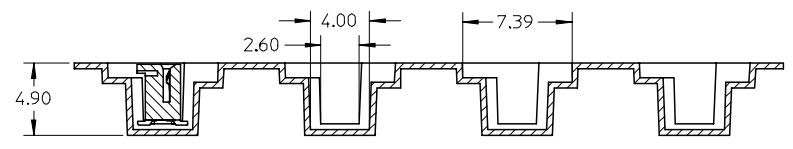

SECTION Z-Z

DETAIL 1

REVISED EC NO: S2007-0721 DRWN: BOKOK CHKD: CGOH APPR: KCLING 2007/03/05 2007/03/05 2007/03/05	QUALITY SYMBOLS ▽=0 ▽=0	GENERAL TOLERANCES (UNLESS SPECIFIED)		DIMENSION STYLE MM ONLY		SCALE NTS	DESIGN UNITS METRIC	THIRD ANGLE PROJECTION			
		4 PLACES ± --- ± ---	3 PLACES ± --- ± ---	2 PLACES ± 0.15 ± ---	1 PLACE ± --- ± ---	ANGULAR ± 3 °	DRAWN BY YLQ1A0	DATE 2006/04/11	TITLE 0.50MM PITCH, FPC CONN. NON-ZIF, SMT		
		DRAFT WHERE APPLICABLE MUST REMAIN WITHIN DIMENSIONS					CHECKED BY BOKOK	DATE 2006/04/18	MOLEX INCORPORATED		
		SEE TABLE					APPROVED BY PTLIM	DATE 2006/04/18	DOCUMENT NO. SD-78119-001	SHEET NO. 5 OF 7	

9 8 7 6 5 4 3 2 1

GOLD PLATING TERMINAL ASSEMBLY PART NUMBERS

ASSY P/N PACKED IN T&R	ASSY P/N W/O PACKAGING	CKT	W	So	F	Bo	B	EMBOSSSED TYPE	ASSY P/N PACKED IN T&R	ASSY P/N W/O PACKAGING	CKT	W	So	F	Bo	B	EMBOSSSED TYPE			
78119-1068	78119-0068	6	24.00	-	11.50	5.40	3.10	A	78119-1318	78119-0318	31	32.00	28.40	14.20	17.90	15.60	B			
78119-1078	78119-0078	7	24.00	-	11.50	5.90	3.60		78119-1328	78119-0328	32	32.00	28.40	14.20	18.40	16.10				
78119-1088	78119-0088	8	24.00	-	11.50	6.40	4.10		78119-1338	78119-0338	33	32.00	28.40	14.20	18.90	16.60				
78119-1098	78119-0098	9	24.00	-	11.50	6.90	4.60		78119-1348	78119-0348	34	32.00	28.40	14.20	19.40	17.10				
78119-1108	78119-0108	10	24.00	-	11.50	7.40	5.10		78119-1358	78119-0358	35	32.00	28.40	14.20	19.90	17.60				
78119-1118	78119-0118	11	24.00	-	11.50	7.90	5.60		78119-1368	78119-0368	36	32.00	28.40	14.20	20.40	18.10				
78119-1128	78119-0128	12	24.00	-	11.50	8.40	6.10		78119-1378	78119-0378	37	32.00	28.40	14.20	20.90	18.60				
78119-1138	78119-0138	13	24.00	-	11.50	8.90	6.60		78119-1388	78119-0388	38	32.00	28.40	14.20	21.40	19.10				
78119-1148	78119-0148	14	24.00	-	11.50	9.40	7.10		78119-1398	78119-0398	39	44.00	40.40	20.20	21.90	19.60				
78119-1158	78119-0158	15	24.00	-	11.50	9.90	7.60		78119-1408	78119-0408	40	44.00	40.40	20.20	22.40	20.10				
78119-1168	78119-0168	16	24.00	-	11.50	10.40	8.10		78119-1418	78119-0418	41	44.00	40.40	20.20	22.90	20.60				
78119-1178	78119-0178	17	24.00	-	11.50	10.90	8.60		78119-1428	78119-0428	42	44.00	40.40	20.20	23.40	21.10				
78119-1188	78119-0188	18	24.00	-	11.50	11.40	9.10													
78119-1198	78119-0198	19	24.00	-	11.50	11.90	9.60													
78119-1208	78119-0208	20	24.00	-	11.50	12.40	10.10													
78119-1218	78119-0218	21	32.00	28.40	14.20	12.90	10.60		B											
78119-1228	78119-0228	22	32.00	28.40	14.20	13.40	11.10													
78119-1238	78119-0238	23	32.00	28.40	14.20	13.90	11.60													
78119-1248	78119-0248	24	32.00	28.40	14.20	14.40	12.10													
78119-1258	78119-0258	25	32.00	28.40	14.20	14.90	12.60													
78119-1268	78119-0268	26	32.00	28.40	14.20	15.40	13.10													
78119-1278	78119-0278	27	32.00	28.40	14.20	15.90	13.60													
78119-1288	78119-0288	28	32.00	28.40	14.20	16.40	14.10													
78119-1298	78119-0298	29	32.00	28.40	14.20	16.90	14.60													
78119-1308	78119-0308	30	32.00	28.40	14.20	17.40	15.10													

REVISED EC NO: S2007-0721 DRWN: BOKOK CHKD: CGOH APPR: KCLING 2007/03/05 2007/03/05 2007/03/05	QUALITY SYMBOLS	GENERAL TOLERANCES (UNLESS SPECIFIED)	DIMENSION STYLE	SCALE	DESIGN UNITS	THIRD ANGLE PROJECTION
	$\nabla = 0$ $\triangle = 0$	mm    INCH 4 PLACES ± --- ± --- 3 PLACES ± --- ± --- 2 PLACES ± 0.15 ± --- 1 PLACE ± --- ± --- ANGULAR ± 3°	MM ONLY	NTS	METRIC	TITLED 0.50MM PITCH, FPC CONN. NON-ZIF, SMT
	DESCRIPTION	DRAFT WHERE APPLICABLE MUST REMAIN WITHIN DIMENSIONS	DRAWN BY    DATE YLQIAO    2006/04/11 CHECKED BY    DATE BOKOK    2006/04/18 APPROVED BY    DATE PTL IM    2006/04/18			MOLEX INCORPORATED DOCUMENT NO. SD-78119-001
	REV		SIZE A3			SHEET NO. 6 OF 7



TIN-BISMUTH PLATING TERMINAL ASSEMBLY PART NUMBERS

ASSY P/N PACKED IN T&R	ASSY P/N W/O PACKAGING	CKT	W	So	F	Bo	B	EMBOSSED TYPE	ASSY P/N PACKED IN T&R	ASSY P/N W/O PACKAGING	CKT	W	So	F	Bo	B	EMBOSSED TYPE			
78119-1069	78119-0069	6	24.00	-	11.50	5.40	3.10	A	78119-1319	78119-0319	31	32.00	28.40	14.20	17.90	15.60	B			
78119-1079	78119-0079	7	24.00	-	11.50	5.90	3.60		78119-1329	78119-0329	32	32.00	28.40	14.20	18.40	16.10				
78119-1089	78119-0089	8	24.00	-	11.50	6.40	4.10		78119-1339	78119-0339	33	32.00	28.40	14.20	18.90	16.60				
78119-1099	78119-0099	9	24.00	-	11.50	6.90	4.60		78119-1349	78119-0349	34	32.00	28.40	14.20	19.40	17.10				
78119-1109	78119-0109	10	24.00	-	11.50	7.40	5.10		78119-1359	78119-0359	35	32.00	28.40	14.20	19.90	17.60				
78119-1119	78119-0119	11	24.00	-	11.50	7.90	5.60		78119-1369	78119-0369	36	32.00	28.40	14.20	20.40	18.10				
78119-1129	78119-0129	12	24.00	-	11.50	8.40	6.10		78119-1379	78119-0379	37	32.00	28.40	14.20	20.90	18.60				
78119-1139	78119-0139	13	24.00	-	11.50	8.90	6.60		78119-1389	78119-0389	38	32.00	28.40	14.20	21.40	19.10				
78119-1149	78119-0149	14	24.00	-	11.50	9.40	7.10		78119-1399	78119-0399	39	44.00	40.40	20.20	21.90	19.60				
78119-1159	78119-0159	15	24.00	-	11.50	9.90	7.60		78119-1409	78119-0409	40	44.00	40.40	20.20	22.40	20.10				
78119-1169	78119-0169	16	24.00	-	11.50	10.40	8.10		78119-1419	78119-0419	41	44.00	40.40	20.20	22.90	20.60				
78119-1179	78119-0179	17	24.00	-	11.50	10.90	8.60		78119-1429	78119-0429	42	44.00	40.40	20.20	23.40	21.10				
78119-1189	78119-0189	18	24.00	-	11.50	11.40	9.10													
78119-1199	78119-0199	19	24.00	-	11.50	11.90	9.60													
78119-1209	78119-0209	20	24.00	-	11.50	12.40	10.10													
78119-1219	78119-0219	21	32.00	28.40	14.20	12.90	10.60		B											
78119-1229	78119-0229	22	32.00	28.40	14.20	13.40	11.10													
78119-1239	78119-0239	23	32.00	28.40	14.20	13.90	11.60													
78119-1249	78119-0249	24	32.00	28.40	14.20	14.40	12.10													
78119-1259	78119-0259	25	32.00	28.40	14.20	14.90	12.60													
78119-1269	78119-0269	26	32.00	28.40	14.20	15.40	13.10													
78119-1279	78119-0279	27	32.00	28.40	14.20	15.90	13.60													
78119-1289	78119-0289	28	32.00	28.40	14.20	16.40	14.10													
78119-1299	78119-0299	29	32.00	28.40	14.20	16.90	14.60													
78119-1309	78119-0309	30	32.00	28.40	14.20	17.40	15.10													

REVISED EC NO: S2007-0721 DRWN: BOKOK CHKD: CGOH APPR: KCLING 2007/03/05 2007/03/05 2007/03/05	QUALITY SYMBOLS	GENERAL TOLERANCES (UNLESS SPECIFIED)	DIMENSION STYLE	SCALE	DESIGN UNITS	THIRD ANGLE PROJECTION	
	$\nabla=0$ $\nabla C=0$	mm INCH 4 PLACES ± --- ± --- 3 PLACES ± --- ± --- 2 PLACES ± 0.15 ± --- 1 PLACE ± --- ± --- ANGULAR ± 3 °	MM ONLY	NTS	METRIC	YLQ1A0 2006/04/11 BOKOK 2006/04/18 PTL IM 2006/04/18	0.50MM PITCH, FPC CONN. NON-ZIF, SMT
		DRAFT WHERE APPLICABLE MUST REMAIN WITHIN DIMENSIONS	SEE TABLE			MOLEX INCORPORATED SD-78119-001	SHEET NO. 7 OF 7
	A2					THIS DRAWING CONTAINS INFORMATION THAT IS PROPRIETARY TO MOLEX INCORPORATED AND SHOULD NOT BE USED WITHOUT WRITTEN PERMISSION	