

General Description

SY8113I is a high efficiency 500kHz synchronous step-down DC/DC regulator capable of delivering up to 3A load current. It can operate over a wide input voltage range from 4.2V to 18V and integrates main switch and synchronous switch with very low $R_{DS(ON)}$ to minimize the conduction loss.

SY8113I adopts the instant PWM architecture to achieve fast transient responses for high step down applications and high efficiency at light loads. In addition, it operates at pseudo-constant frequency of 500kHz to minimize the size of inductor and capacitor.

Ordering Information

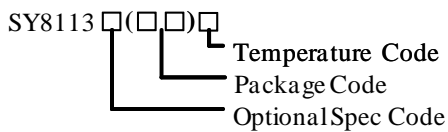

Ordering Number	Package type	Note
SY8113IADC	TSOT23-6	----

Features

- Low $R_{DS(ON)}$ for Internal Switches (Top/Bottom): 80mΩ/40mΩ
- 4.2-18V Input Voltage Range
- 3A Output Current Capability
- 500kHz Switching Frequency Minimize the External Components
- Stable with 22 μF C_{OUT} and 2.2 μH Inductor
- Instant PWM Architecture to Achieve Fast Transient Responses
- Internal Soft-Start Limits the Inrush Current
- Cycle-by-cycle Peak/Valley Current Limitation
- Hic-cup Mode Output Short Circuit Protection
- Thermal Shutdown with Auto Recovery
- Output Auto Discharge Function
- Compact Package: TSOT23-6

Applications

- Set Top Box
- Portable TV
- DSL Modem
- LCD TV
- IP CAM
- Networking

Typical Application

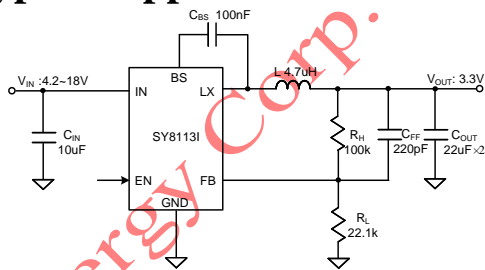

Figure1. Schematic Diagram Inductor and C_{OUT} Selection Table

V_{OUT} [V]	L [μH]	C_{OUT} [μF]			
		4.7	10	22	2×22
1.2	2.2			√	☆
	4.7				
3.3	2.2		√	√	√
	4.7		√	√	☆
5	3.3		√	√	√
	6.8		√	√	☆

Note: '☆' means recommended for most applications.

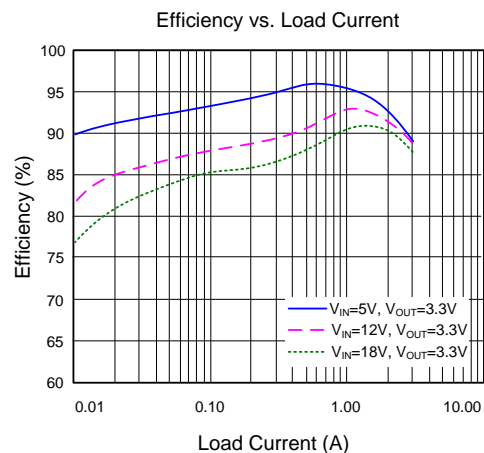
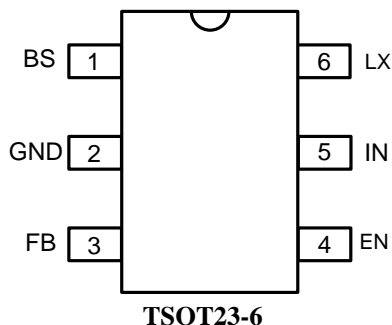

Figure2. Efficiency vs. Output Current

Pin-out (top view)



Top mark: **dKxyz** (Device code: dK, *x=year code*, *y=week code*, *z=lot number code*)

Pin Name	Pin Number	Pin Description
BS	1	Boot-Strap Pin. Supply high side gate driver. Connect a 0.1uF ceramic cap between BS and LX pin.
GND	2	Ground pin.
FB	3	Output feedback pin. Connect this pin to the center point of the output resistor divider (as shown in Figure 1) to program the output voltage: $V_{OUT}=0.6 \times (1+R_H/R_L)$.
EN	4	Enable control. Pull high to turn on. Do not leave this pin floating.
IN	5	Input pin. Decouple this pin to GND pin with at least 10 μ F ceramic cap.
LX	6	Inductor pin. Connect this pin to the switching node of inductor.

Absolute Maximum Ratings (Note 1)

Supply Input Voltage	-----	-0.3V to 19V
LX, EN Voltage	-----	-0.3V to $V_{IN} + 0.3V$
FB, BS-LX Voltage	-----	-0.3V to 4V
Power Dissipation, P_D @ $T_A = 25^\circ C$ TSOT23-6,	-----	2.0W
Package Thermal Resistance (Note 2)		
θ_{JA}	-----	50 $^\circ C/W$
θ_{JC}	-----	12 $^\circ C/W$
Junction Temperature Range	-----	-40 $^\circ C$ to 150 $^\circ C$
Lead Temperature (Soldering, 10 sec.)	-----	260 $^\circ C$
Storage Temperature Range	-----	-65 $^\circ C$ to 150 $^\circ C$
Dynamic LX Voltage in 10ns Duration (Note3)	-----	$IN+3V$ to $GND-5V$

Recommended Operating Conditions (Note 3)

Supply Input Voltage	-----	4.2V to 18V
Junction Temperature Range	-----	-40 $^\circ C$ to 125 $^\circ C$
Ambient Temperature Range	-----	-40 $^\circ C$ to 85 $^\circ C$

Electrical Characteristics

($V_{IN} = 12V$, $V_{OUT} = 3.3V$, $L = 4.7 \mu H$, $C_{OUT} = 22 \mu F \times 2$, $T_A = 25^\circ C$, $I_{OUT} = 1A$ unless otherwise specified)

Parameter	Symbol	Test Conditions	Min	Typ	Max	Unit
Input Voltage Range	V_{IN}		4.2		18	V
Input UVLO Threshold	V_{UVLO}				4.15	V
Input UVLO Hysteresis	V_{HYS}			0.3		V
Quiescent Current	I_Q	$I_{OUT}=0$, $V_{FB}=V_{REF} \times 105\%$		200		μA
Shutdown Current	I_{SHDN}	$EN=0$		5	10	μA
Feedback Reference Voltage	V_{REF}		591	600	609	mV
FB Input Current	I_{FB}	$V_{FB}=3.3V$	-50		50	nA
Output Discharge Resistance	R_{DIS}			40		Ω
Top FET R_{ON}	$R_{DS(ON)1}$			80		m Ω
Bottom FET R_{ON}	$R_{DS(ON)2}$			40		m Ω
EN Rising Threshold	$V_{EN,R}$		1.08	1.2	1.32	V
EN Falling Threshold	$V_{EN,F}$		0.9	1.0	1.1	V
Min ON Time	$t_{ON,MIN}$			50		ns
Min OFF Time	$t_{OFF,MIN}$			100		ns
Soft-start Time	t_{SS}			1		ms
Switching Frequency	F_{SW}	$V_{OUT}=3.3V$, CCM		500		kHz
Top FET Current Limit	$I_{LIM, TOP}$		4.5			A
Bottom FET Current Limit	$I_{LIM, BOT}$		3			A
Output Under Voltage Protection Threshold	V_{UVP}			33%		V_{REF}
Output UVP Delay	$t_{UVP, DLY}$			100		μs
UVP Hiccup On Time	$t_{UVP, ON}$			2.5		ms
UVP Hiccup Off Time	$t_{UVP, OFF}$			9		ms
Thermal Shutdown Temperature	T_{SD}			150		$^\circ C$
Thermal Shutdown Hysteresis	T_{HYS}			15		$^\circ C$

Note 1: Stresses beyond the “Absolute Maximum Ratings” may cause permanent damage to the device. These are stress ratings only. Functional operation of the device at these or any other conditions beyond those indicated in the operational sections of the specification is not implied. Exposure to absolute maximum rating conditions for extended periods may affect device reliability.

Note 2: θ_{JA} is measured in the natural convection at $T_A = 25^\circ C$ on a 2OZ two-layer Silergy evaluation board. Paddle of TSOT23-6 package is the case position for SY8113I θ_{JC} measurement.

Note 3: The device is not guaranteed to function outside its operating conditions.

Typical Performance Characteristics

Efficiency vs. Load Current

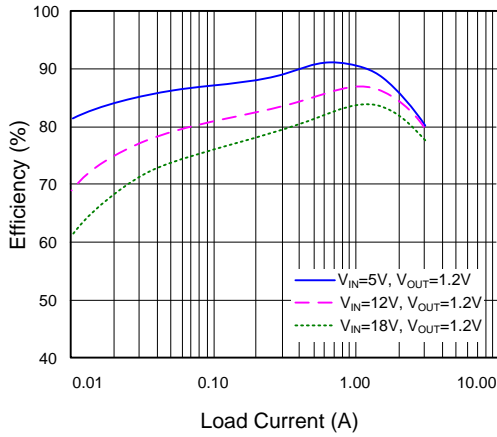

Efficiency vs. Load Current

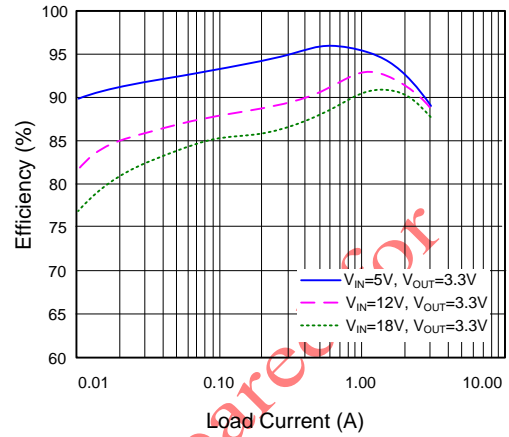

Efficiency vs. Load Current

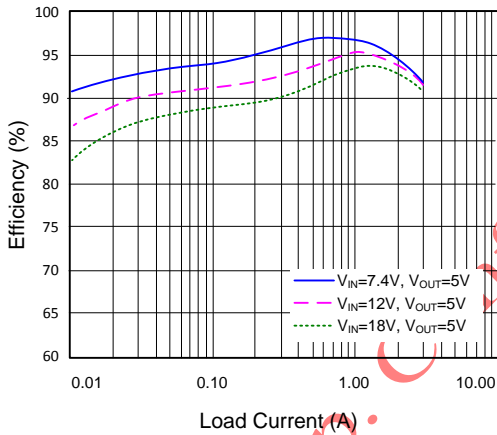

Output Ripple

($V_{IN}=12V, V_{OUT}=3.3V, I_{LOAD}=0A$)

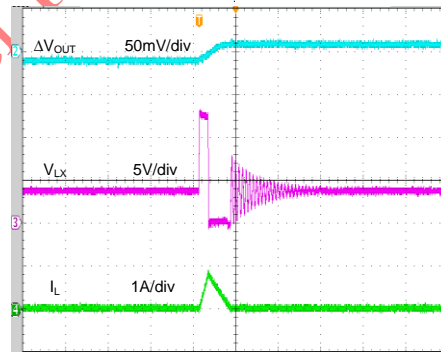

Output Ripple

($V_{IN}=12V, V_{OUT}=3.3V, I_{LOAD}=3A$)

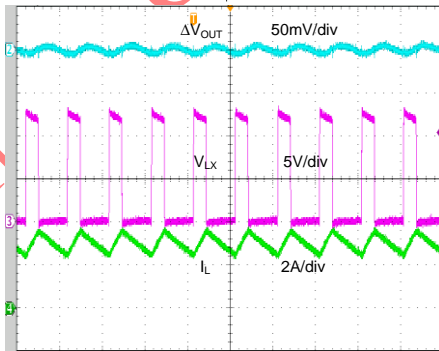

Load Transient

($V_{IN}=12V, V_{OUT}=3.3V, I_{LOAD}=0.3-3A$)

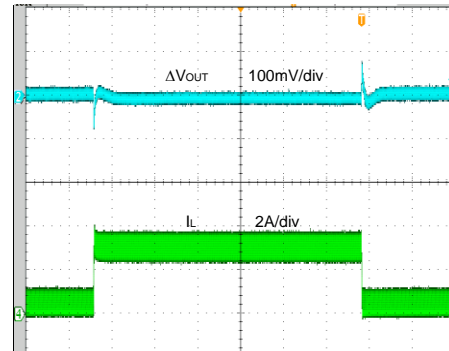

Load Transient

($V_{IN}=12V$, $V_{OUT}=3.3V$, $I_{LOAD}=1.5-3A$)

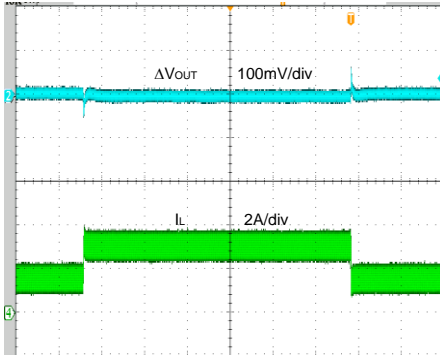

Time (400 μ s/div)

Startup from Enable

($V_{IN}=12V$, $V_{OUT}=3.3V$, $I_{LOAD}=3A$)

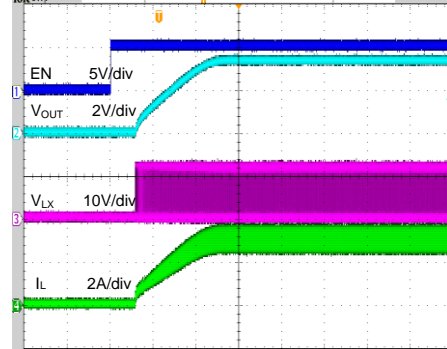

Time (800 μ s/div)

Shutdown from Enable

($V_{IN}=12V$, $V_{OUT}=3.3V$, $I_{LOAD}=3A$)

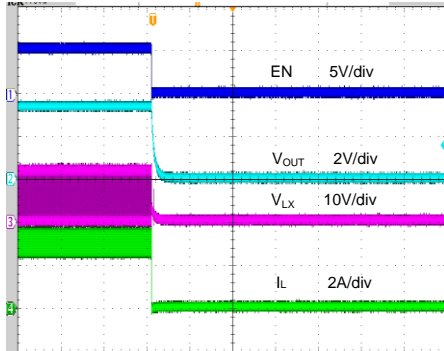

Time (800 μ s/div)

Startup from V_{IN}

($V_{IN}=12V$, $V_{OUT}=3.3V$, $I_{LOAD}=3A$)

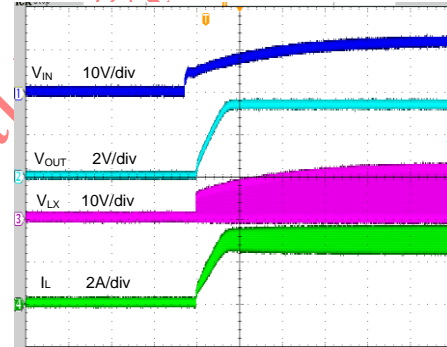

Time (2ms/div)

Shutdown from V_{IN}

($V_{IN}=12V$, $V_{OUT}=3.3V$, $I_{LOAD}=3A$)

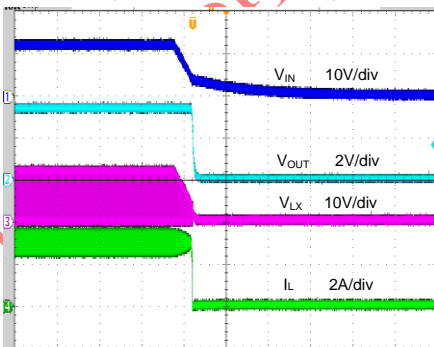

Time (2ms/div)

Short Circuit Protection

($V_{IN}=12V$, $V_{OUT}=3.3V$, Open to Short)

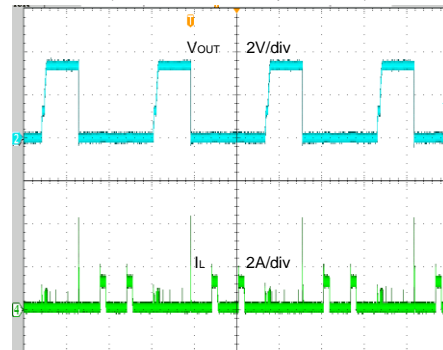

Time (20ms/div)

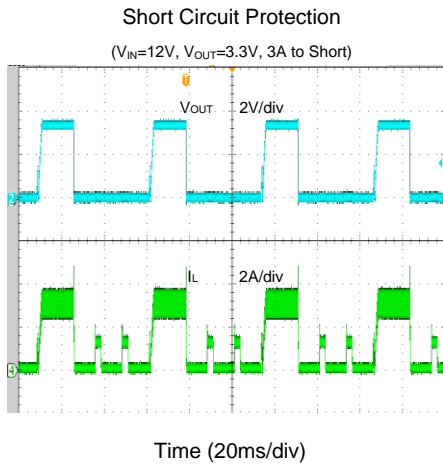

Silergy Corp. Confidential Prepared for

Operation

SY8113I is a high efficiency 500kHz synchronous step-down DC/DC regulator capable of delivering up to 3A load current. It can operate over a wide input voltage range from 4.2V to 18V and integrates main switch and synchronous switch with very low $R_{DS(ON)}$ to minimize the conduction loss. SY8113I adopts the instant PWM architecture to achieve fast transient responses for high step down applications and high efficiency at light loads.

SY8113I provides protection functions such as cycle by cycle current limiting and thermal shutdown protection. SY8113I will sense the output voltage conditions for the fault protection.

Applications Information

Because of the high integration in the SY8113I IC, the application circuit based on this regulator IC is rather simple. Only input capacitor C_{IN} , output capacitor C_{OUT} , output inductor L and feedback resistors (R_H and R_L) need to be selected for the targeted applications specifications.

Feedback Resistor Dividers R_H and R_L

Choose R_H and R_L to program the proper output voltage. To minimize the power consumption under light loads, it is desirable to choose large resistance values for both R_H and R_L . A value of between 10k Ω and 1M Ω is highly recommended for both resistors. If V_{OUT} is 3.3V, $R_H=100k$ is chosen, then using following equation, R_L can be calculated to be 22.1k:

$$R_L = \frac{0.6V}{V_{OUT} - 0.6V} R_H$$

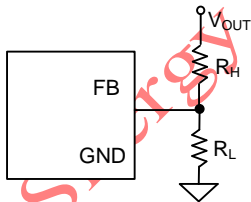

Input Capacitor C_{IN} :

The ripple current through input capacitor is calculated as:

$$I_{CIN_RMS} = I_{OUT} \cdot \sqrt{D(1-D)}$$

To minimize the potential noise problem, place a typical X5R or better grade ceramic capacitor really close to the IN and GND pins. Care should be taken to minimize the loop area formed by C_{IN} , and IN/GND pins. In this case, a 10 μ F low ESR ceramic capacitor is recommended.

Output Capacitor C_{OUT}

The output capacitor is selected to handle the output ripple noise requirements. Both steady state ripple and transient requirements must be taken into consideration when selecting this capacitor. For the best performance, it is recommended to use X5R or better grade ceramic capacitor with 16V rating and more than 22 μ F capacitance.

Output Inductor L

There are several considerations in choosing this inductor.

- 1) Choose the inductance to provide the desired ripple current. It is suggested to choose the ripple current to be about 40% of the maximum output current. The inductance is calculated as:

$$L = \frac{V_{OUT}(1 - V_{OUT}/V_{IN,MAX})}{F_{SW} \times I_{OUT,MAX} \times 40\%}$$

Where F_{sw} is the switching frequency and $I_{OUT,MAX}$ is the maximum load current.

The SY8113I regulator IC is quite tolerant of different ripple current amplitude. Consequently, the final choice of inductance can be slightly off the calculation value without significantly impacting the performance.

- 2) The saturation current rating of the inductor must be selected to be greater than the peak inductor current under full load conditions.

$$I_{SAT, MIN} > I_{OUT, MAX} + \frac{V_{OUT}(1 - V_{OUT}/V_{IN,MAX})}{2 \cdot F_{SW} \cdot L}$$

- 3) The DCR of the inductor and the core loss at the switching frequency must be low enough to achieve the desired efficiency requirement. It is desirable to choose an inductor with $DCR < 50m\Omega$ to achieve a good overall efficiency.

Soft-start

The SY8113I has a built-in soft-start to control the rise rate of the output voltage and limit the input current surge during IC start-up. The typical soft-start time is 1ms.

External Bootstrap Cap

This capacitor provides the gate driver voltage for internal high side MOSFET. A 100nF low ESR ceramic capacitor connected between BS pin and LX pin is recommended.

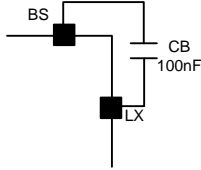

Load Transient Considerations:

The SY8113I regulator IC integrates the compensation components to achieve good stability and fast transient responses. Adding a small ceramic capacitor in parallel with R_H will further speed up the load transient responses.

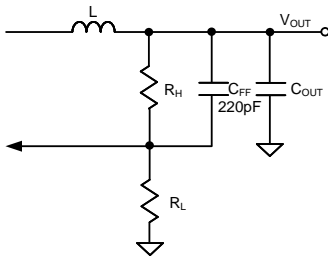

OCP and SCP Protection Method

With load current increasing, the low side FET current will get higher than valley current limit threshold. The low side FET will keep turning on until low side FET current decreases below the valley current limit threshold, so that valley current is limited. If the load current continues to increase, the output voltage will drop. When the output voltage falls below 33% of the

regulation level, the output short is detected and the IC will operate in hic-cup mode. The hic-cup on time is 2.5ms and hic-cup off time is 9ms. If the hard short is removed, the IC will return to normal operation.

Layout Design:

The layout design of SY8113I regulator is relatively simple. For the best efficiency and minimum noise problem, we should place the following components close to the IC: C_{IN} , L, R_H and R_L .

- 1) It is desirable to maximize the PCB copper area connecting to GND pin to achieve the best thermal and noise performance. If the board space allowed, a ground plane is highly desirable.
- 2) C_{IN} must be close to IN and GND pins. The loop area formed by C_{IN} and GND must be minimized.
- 3) The PCB copper area associated with LX pin must be minimized to avoid the potential noise problem.
- 4) The components R_H and R_L , and the trace connecting to the FB pin must NOT be adjacent to the LX net on the PCB layout to avoid the noise problem.
- 5) If the system chip interfacing with the EN pin has a high impedance state at shutdown mode and the IN pin is connected directly to a power source such as a Li-Ion battery, it is desirable to add a pull down 1Mohm resistor between the EN and GND pins to prevent the noise from falsely turning on the regulator at shutdown mode.

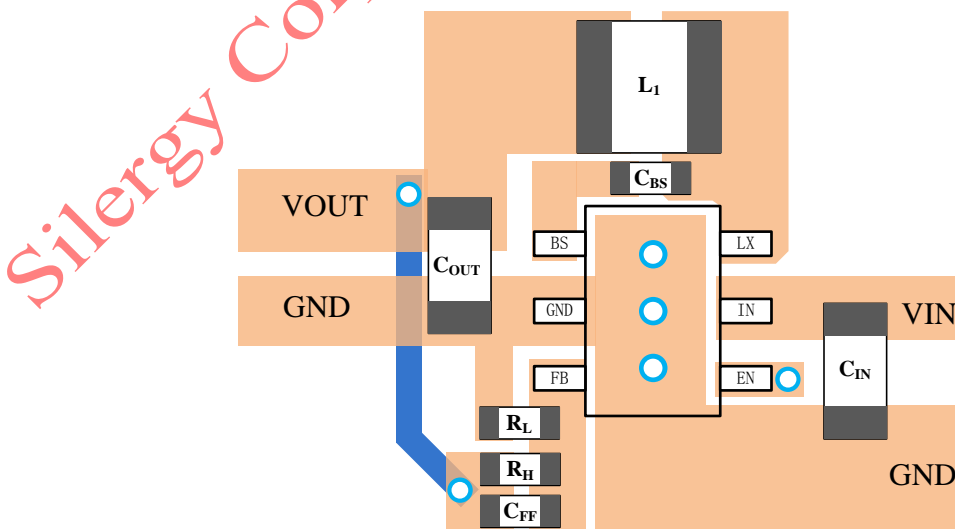

TSOT23-6 Package Outline & PCB Layout

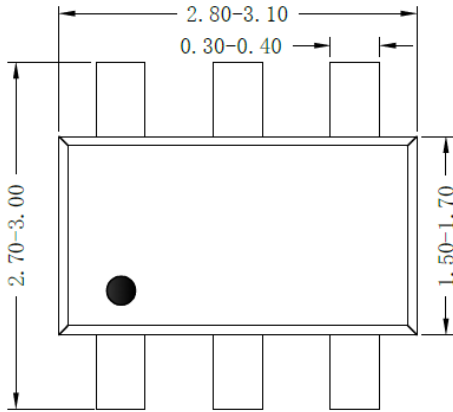

Top view

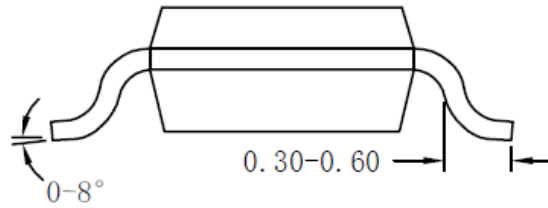

Side view

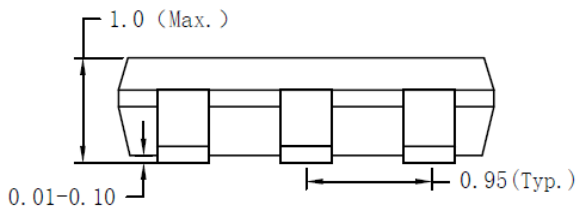

Front view

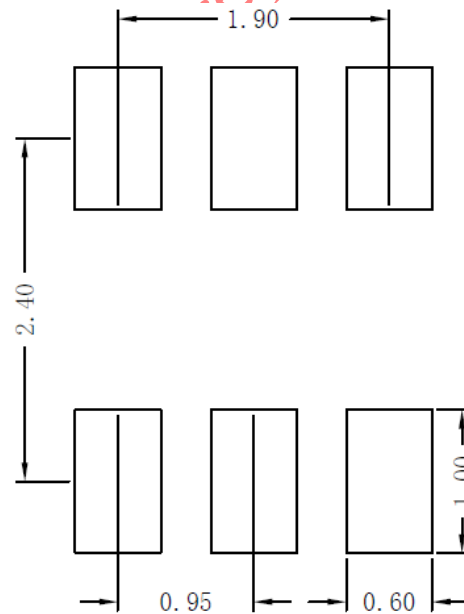

Recommended Pad Layout

Notes: All dimension in millimeter and exclude mold flash & metal burr.

Taping & Reel Specification

1. Taping orientation

TSOT23-6

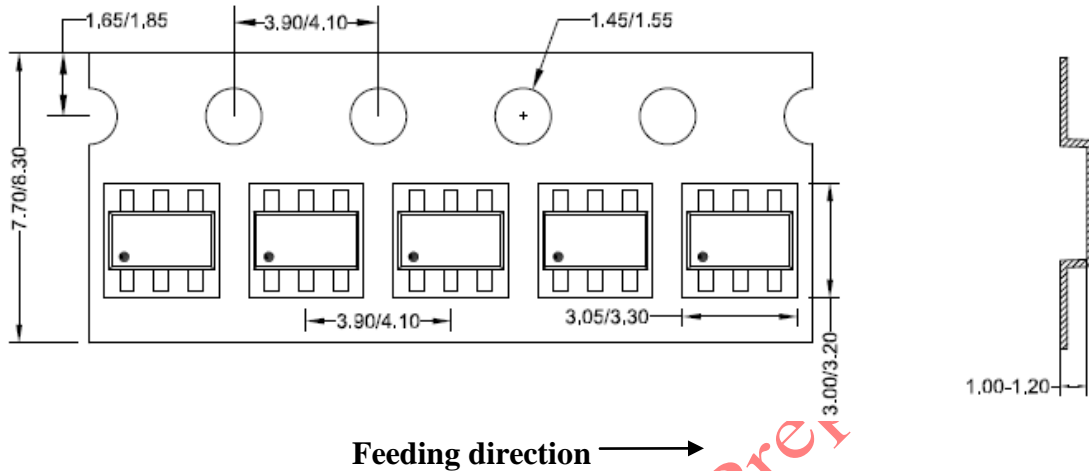

2. Carrier Tape & Reel specification for packages

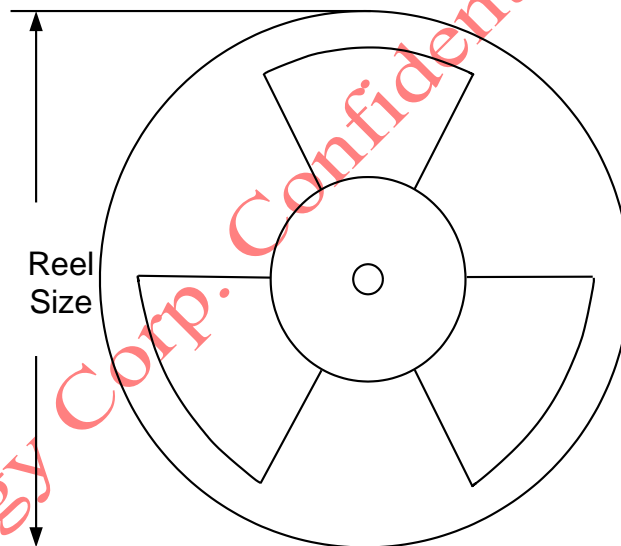

Package types	Tape width (mm)	Pocket pitch(mm)	Reel size (Inch)	Trailer length(mm)	Leader length (mm)	Qty per reel
TSOT23-6	8	4	7"	400	160	3000

3. Others: NA