

8.0A GLASS PASSIVATED BRIDGE RECTIFIER

Reverse Voltage - 100 to 1000 V

Forward Current – 8.0A



FEATURES

- ◆ Surge overload rating-300 amperes peak
- ◆ Polarity:As marked on body
- ◆ Ideal for printed circuit board
- ◆ Plastic material has U/L

The flammability classification 94V-0

- ◆ Reliable low cost construction utilizing molded plastic technique

MECHANICAL DATA

- ◆ Case: KBU
- ◆ Terminals: Solderable per MIL-STD-202, Method 208
- ◆ Approx. Weight: 8.0g /0.3oz

Maximum Ratings and Electrical characteristics

Ratings at 25 °C ambient temperature unless otherwise specified.

Single phase half-wave 60 Hz, resistive or inductive load, for capacitive load current derate by 20 %.

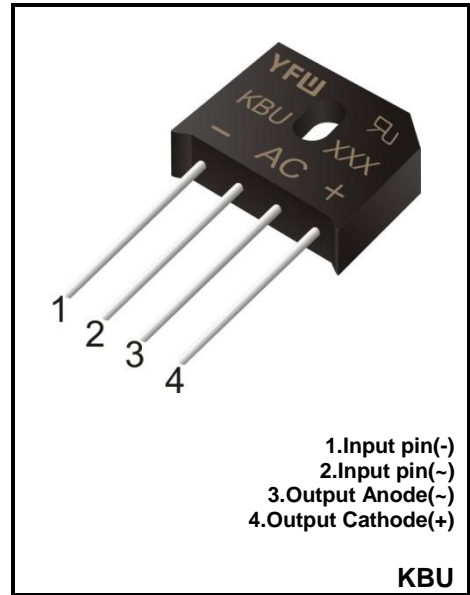

Parameter	Symbols	KBU801	KBU802	KBU804	KBU806	KBU808	KBU810	Units
Maximum Repetitive Peak Reverse Voltage	V_{RRM}	100	200	400	600	800	1000	V
Maximum RMS voltage	V_{RMS}	70	140	280	420	560	700	V
Maximum DC Blocking Voltage	V_{DC}	100	200	400	600	800	1000	V
Maximum Average Forward Rectified Current at $T_C=100^{\circ}C$ (Note 1)	$I_{(AV)}$	8.0						A
Peak Forward Surge Current 8.3 ms Single Half Sine-Wave Superimposed on Rated Load (JEDEC method)	I_{FSM}	300						A
Forward Voltage per element at 4.0A DC and 25°C	V_F	1.0						V
Maximum DC Reverse Current at Rated DC Blocking Voltage @Ta=25°C @Ta=125°C	I_R	10 500						μA
I2t Rating for Fusing(3ms≤t≤8.3ms)	I^2t	180						A ² S
Typical Junction Capacitance (Note1)	C_J	400						pF
Typical Thermal Resistance (Note2)	$R_{\theta JA}/R_{\theta JC}$	18/3.0						°C/W
Operating and Storage Temperature Range	T_j, T_{stg}	-55 ~ +150						°C

(1) Measured at 1 MHz and applied reverse voltage of 4 V D.C

(2) Unit case mounted on 4" x 6" x 0.25" Al plate heat sink.

RATINGS AND CHARACTERISTIC CURVES

FIG.1- MAXIMUM NON-REPETITIVE FORWARD SURGE CURRENT PER BRIDGE ELEMENT

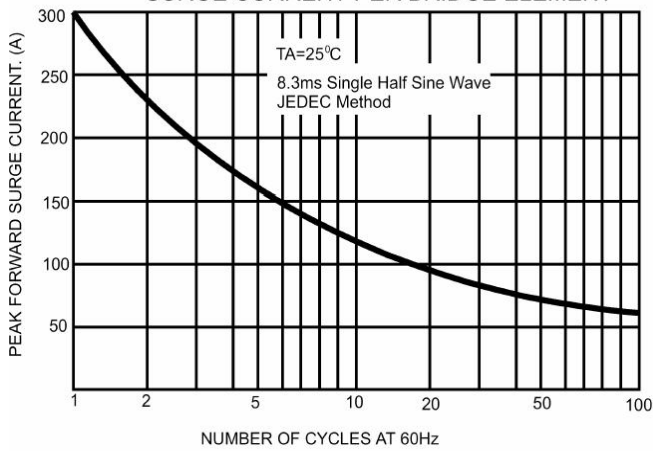

FIG.2- MAXIMUM FORWARD CURRENT DERATING CURVE

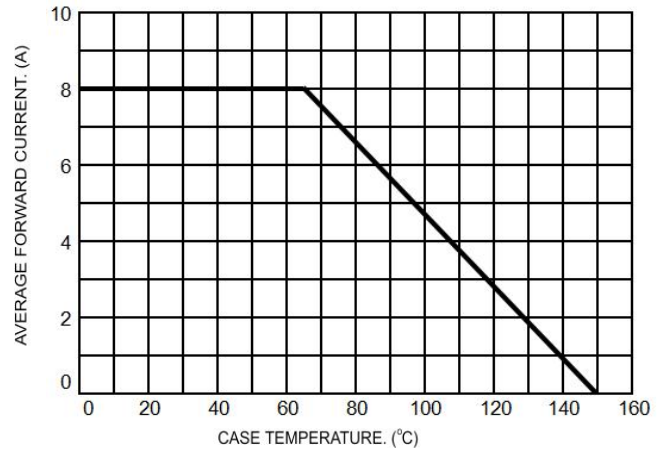

FIG.3- TYPICAL INSTANTANEOUS FORWARD CHARACTERISTICS PER BRIDGE ELEMENT

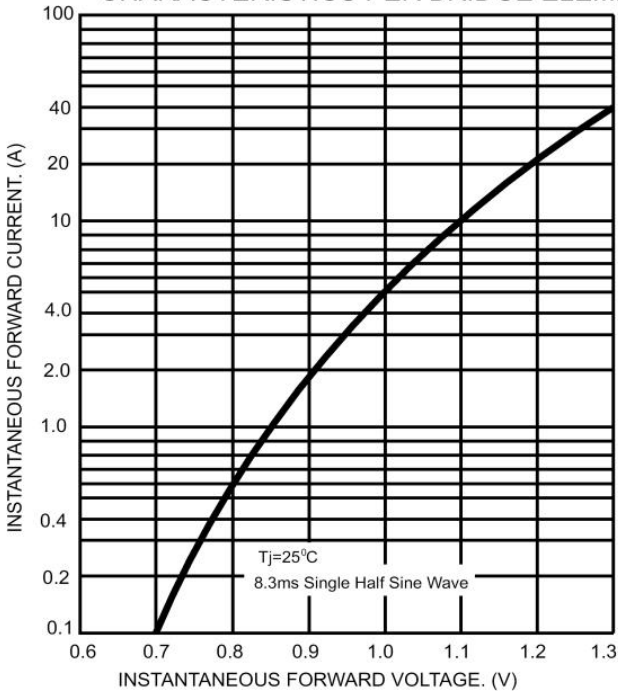

FIG.4- TYPICAL REVERSE CHARACTERISTICS PER BRIDGE ELEMENT

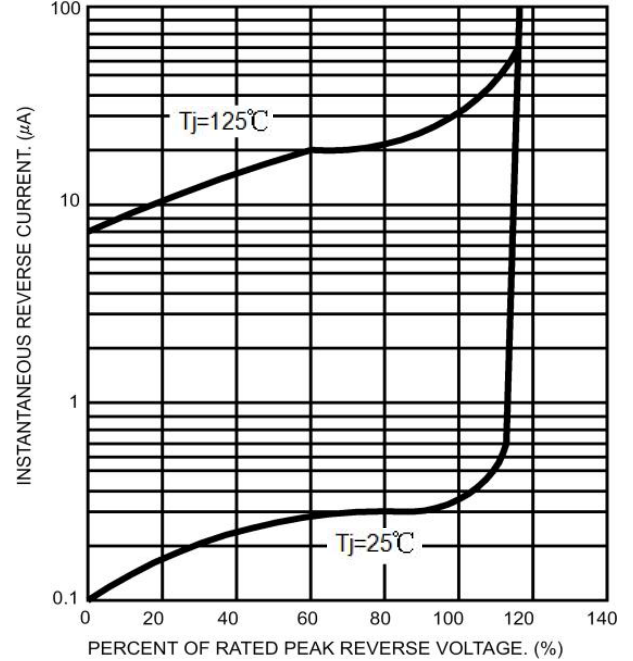
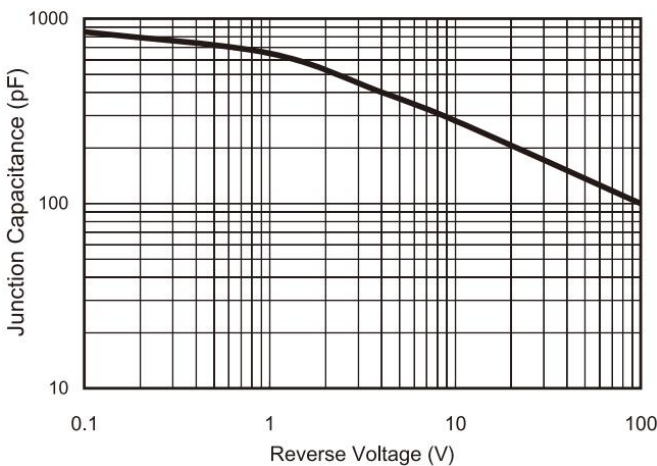
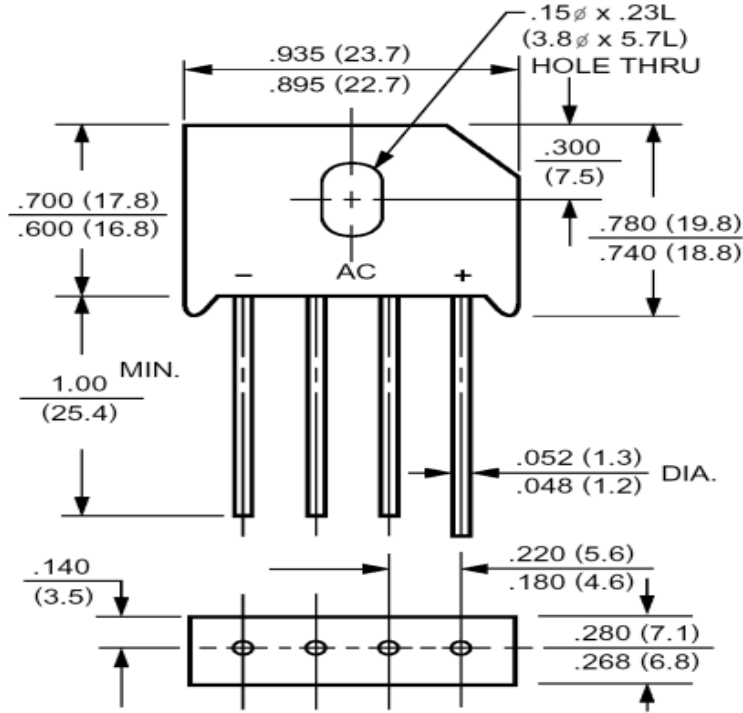

FIG 5 Typical Junction Capacitance



Package Outline

KBU



Summary of Packing Options

Package	Packing Description	Packing Quantity	Industry Standard
KBU	BOX	400	EIA-481-1