

Applications

- VSAT
- Point-to-Point Radio
- Test Equipment & Sensors

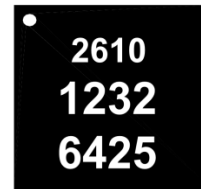

28-pin 5x5 mm QFN package

Product Features

- RF Frequency Range: 10 – 15.4 GHz
- IF Frequency: DC – 4 GHz
- LO Frequency: 6 – 19 GHz
- LO Input Power: 0 to 8 dBm
- Input IP3: 2 dBm
- Conversion Gain: 14 dB
- Noise Figure: ≤ 2.5 dB
- Package Dimensions: 5.0 x 5.0 x 1.3 mm

Functional Block Diagram

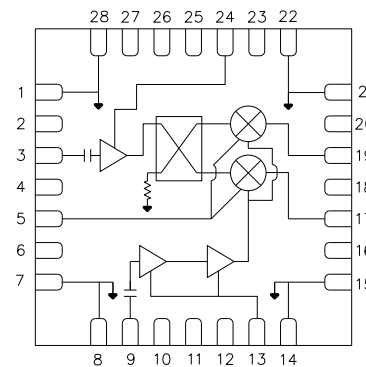

General Description

The TriQuint TGC2610-SM is a Ku-Band Image Reject Downconverter. The TGC2610-SM operates over an RF frequency range of 10 to 15.4 GHz and LO from 6 to 19 GHz with IF outputs from DC to 4 GHz. This part is designed using TriQuint’s pHEMT production process.

The TGC2610-SM integrates an LNA, and image reject mixer driven by an LO buffer amplifier. It typically provides an Input IP3 of 2 dBm at –25 dBm input power per tone and has a conversion gain of 14 dB and noise figure of 2.5 dB or less.

The TGC2610-SM is available in a low-cost, surface mount 28 lead 5x5 mm QFN package and is ideally suited for Point-to-Point Radio, and Ku-Band VSAT Ground Terminal applications.

Lead-free and RoHS compliant.

Evaluation Boards are available upon request.

Pin Configuration

Pin No.	Label
1, 2, 4, 6, 7, 8, 12, 14, 15, 16, 18, 20, 21, 22, 23, 25, 26, 27, 28	GND
3	RF IN
5	VGX
9	LO IN
10, 11	NC
13	VDLO
17	IFOUT_LSB
19	IFOUT_USB
24	VDLNA

Ordering Information

Part No.	ECCN	Description
TGC2610-SM	EAR99	10 GHz – 15.4 GHz Downconverter

Standard T/R size = 500 pieces on a 7” reel

Absolute Maximum Ratings

Parameter	Rating
VDLNA	6 V
VDLO	6 V
IDRF	140 mA
IDLO	150 mA
VGX	0 V
Power Dissipation, Pdiss	1.7 W
RF Input Power, CW, T = 25 °C	16 dBm
Channel Temperature, Tch	200 °C
Mounting Temperature (30 sec)	260 °C
Storage Temperature	-65 to 125 °C

Operation of this device outside the parameter ranges given above may cause permanent damage.

Recommended Operating Conditions

Parameter	Min	Typ	Max	Units
Operating Temperature Range	-40	+25	+85	°C
VDRF	3	4	5	V
IDRF		88		mA
VDLO	3	4	5	V
IDLO		71		mA
VGX		See Note		
LO Input Power	0	4	8	dBm

Electrical specifications are measured at specified test conditions. Specifications are not guaranteed over all recommended operating conditions.

Note: VGX is connected to 23 ohm resistor to ground

Electrical Specifications

Test conditions unless otherwise noted: : IF Input Power = -20 dBm, LO Input Power = 4 dBm, VDLO = 4 V, IDLO = 65 mA, VDRF = 4 V, IDRF = 58 mA.

Parameter	Conditions	Min	Typ	Max	Units
RF Frequency Range		10		15.4	GHz
LO Frequency Range		6		19	GHz
IF Frequency Range		0		4	GHz
LO Input Power		0	4	8	dBm
Drain Current, LO (IDLO)			70		mA
Drain Current, RF (IDRF)			90		mA
Conversion Gain			14		dB
Input Third Order Intercept Point (IIP3)			2		dBm
Image Rejection (IMR)			18		dB
Noise Figure			2		dB

Notes:

1.

Specifications

Thermal and Reliability Information

Parameter	Conditions	Rating
Thermal Resistance, θ_{JC} , measured to back of package	Tbase = 85 °C	$\theta_{JC} = 75.5 \text{ }^\circ\text{C/W}$
Channel Temperature (Tch), and Median Lifetime (Tm)	Tbase = 85 °C Vd = 4 V Id = 160 mA LO Power = 4dBm Pdis = 0.64 W	Tch = 133 °C Tm = 1.8E+9 Hours

Median Lifetime (Tm) vs. Channel Temperature (Tch)

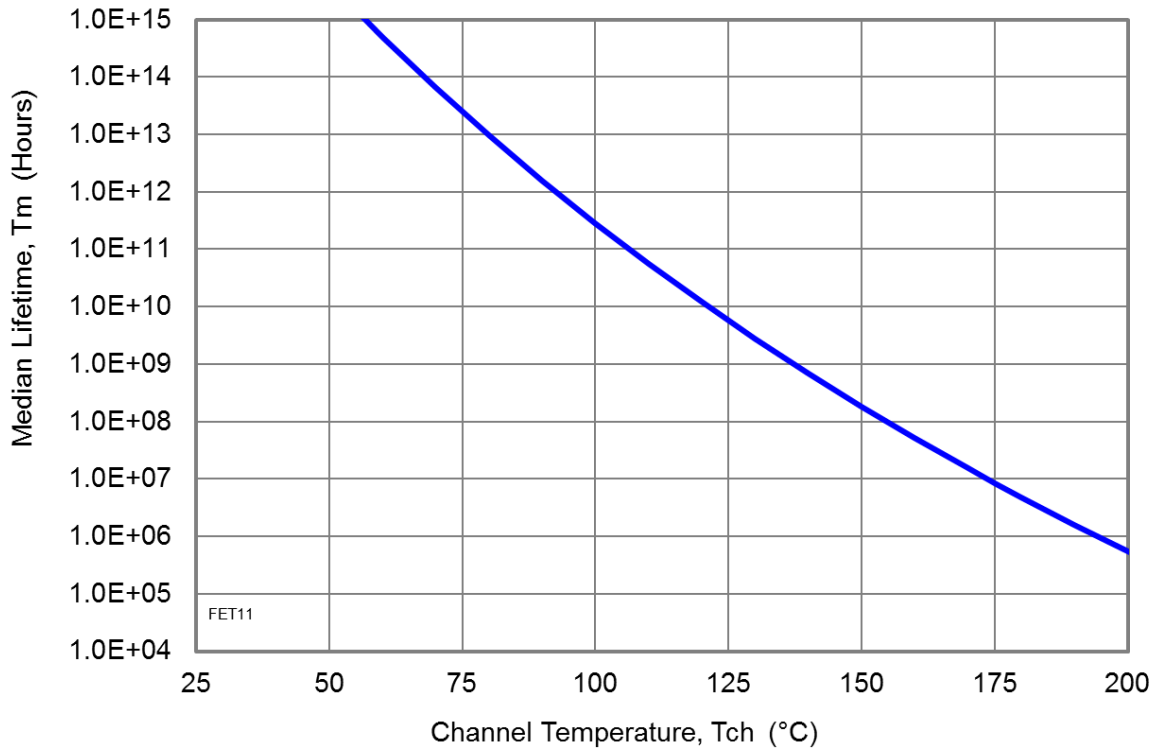

Typical Performance

IF Input Power = -25 dBm, VDLO = 4 V, IDLO = 65 mA, VDRF = 4 V, IDRf = 85 mA.
 Data taken with external IF hybrid.

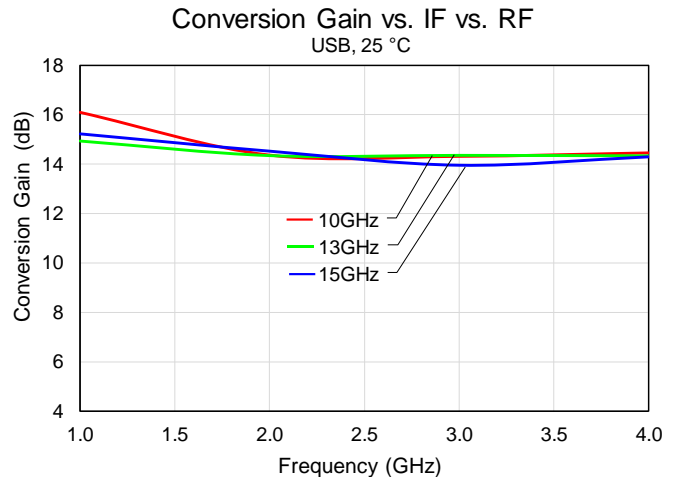
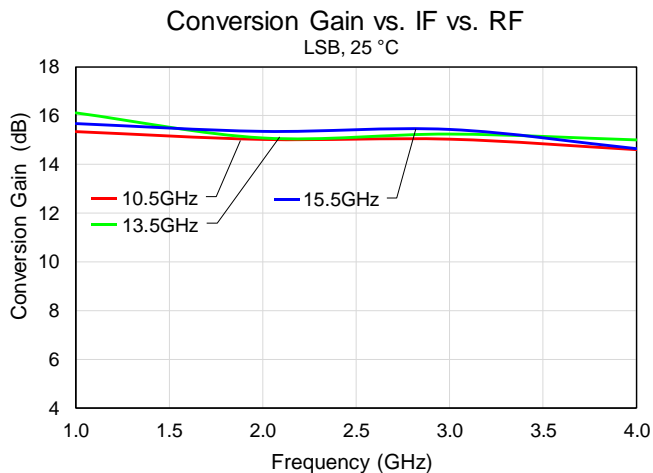
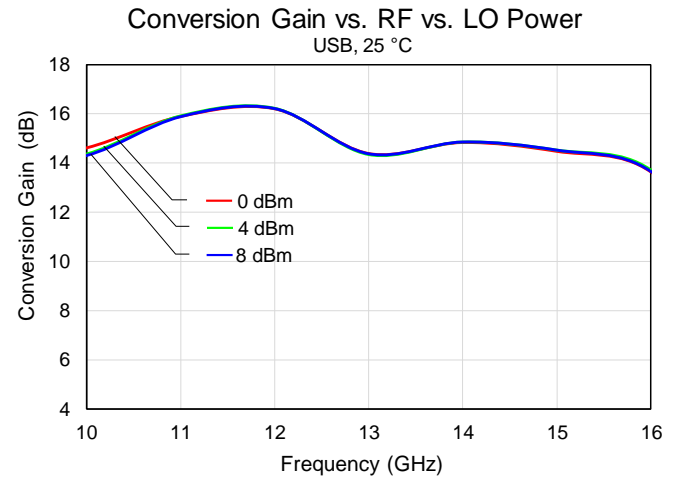
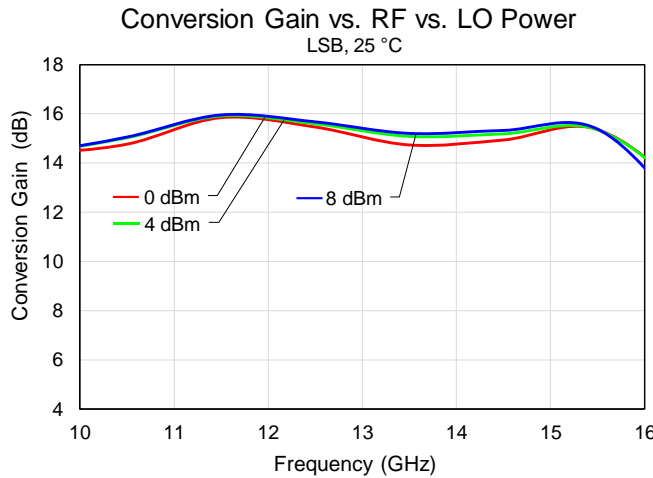
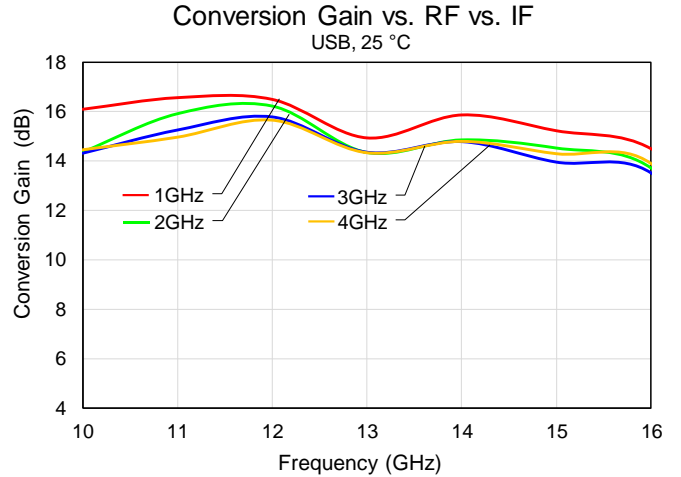
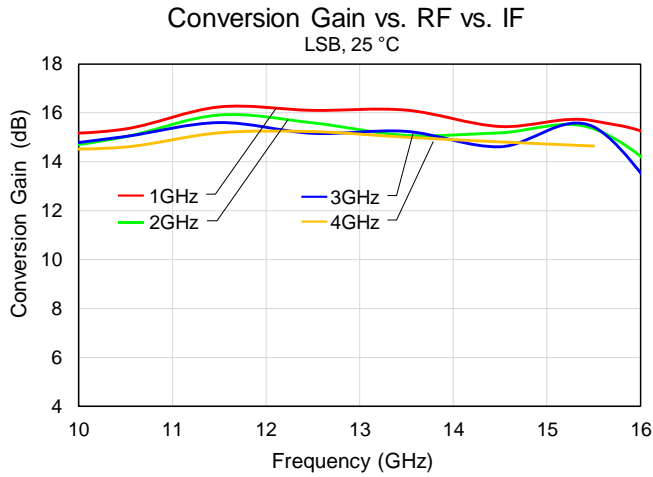

Typical Performance

IF Input Power = -25 dBm, VDLO = 4 V, IDLO = 65 mA, VDRF = 4 V, IDRf = 85 mA.
 Data taken with external IF hybrid.

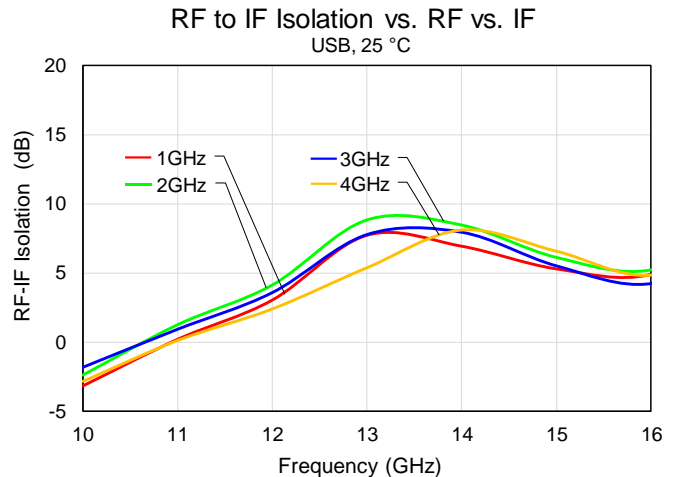
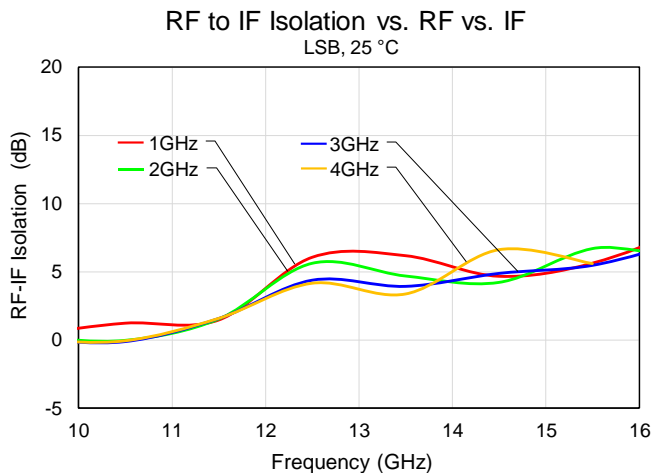
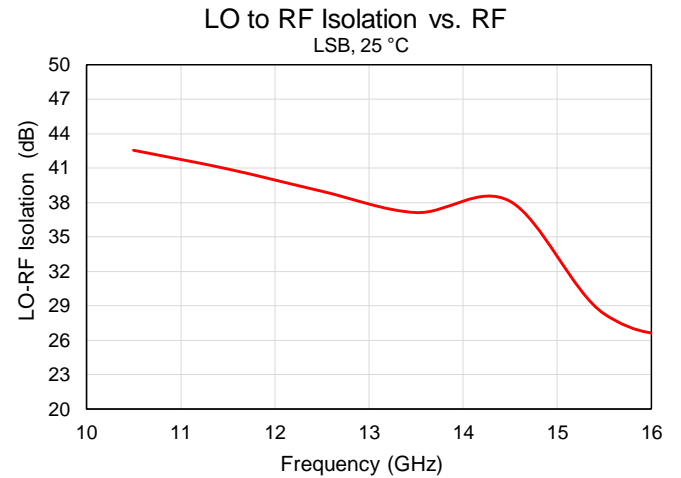
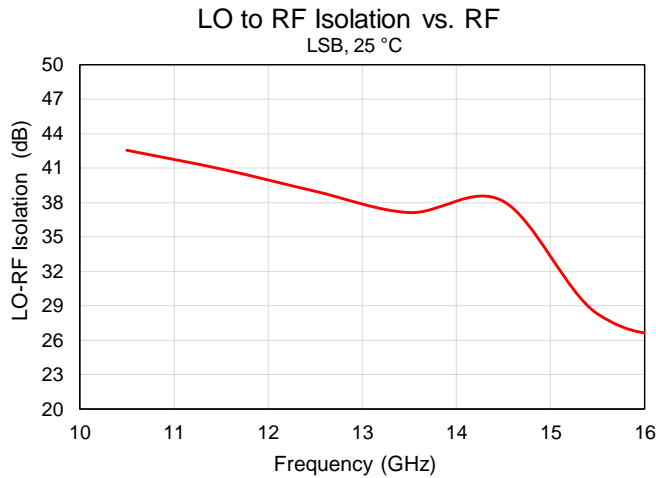
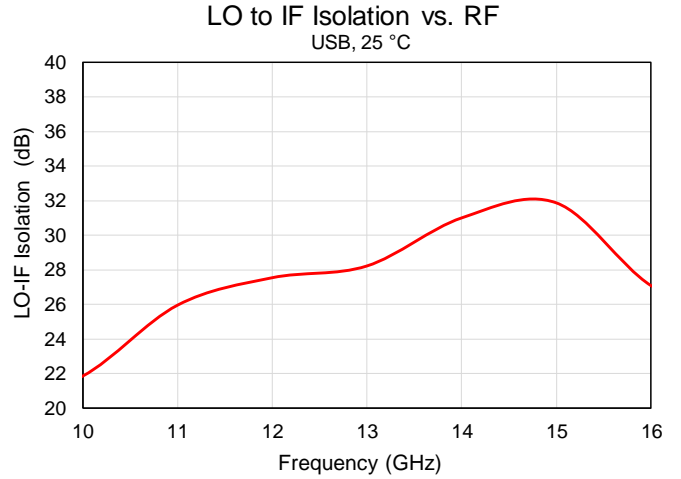
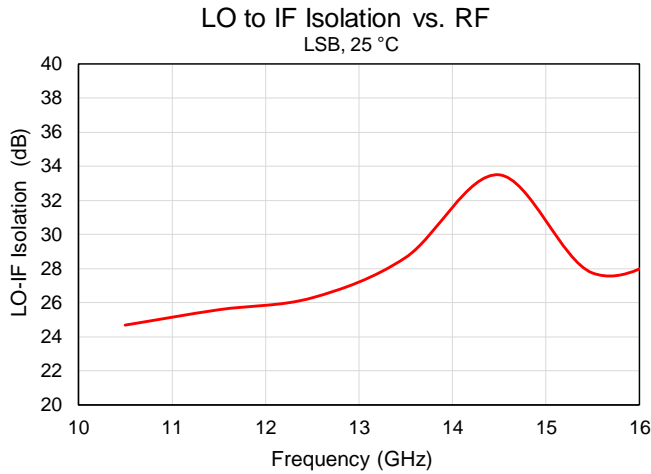

Typical Performance

IF Input Power = -25 dBm, VDLO = 4 V, IDLO = 65 mA, VDRF = 4 V, IDRf = 85 mA.
 Data taken with external IF hybrid.

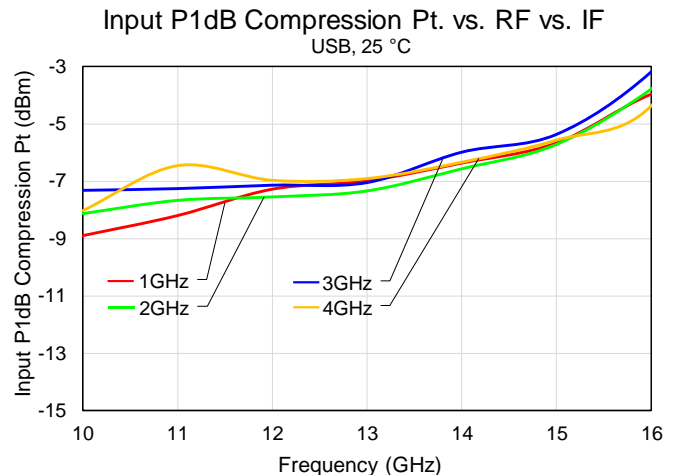
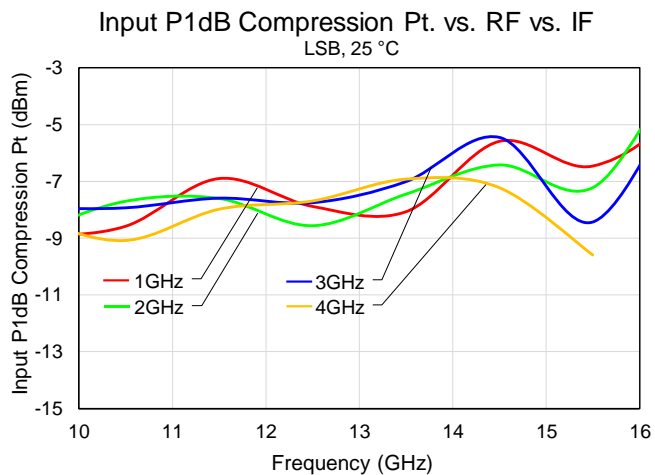
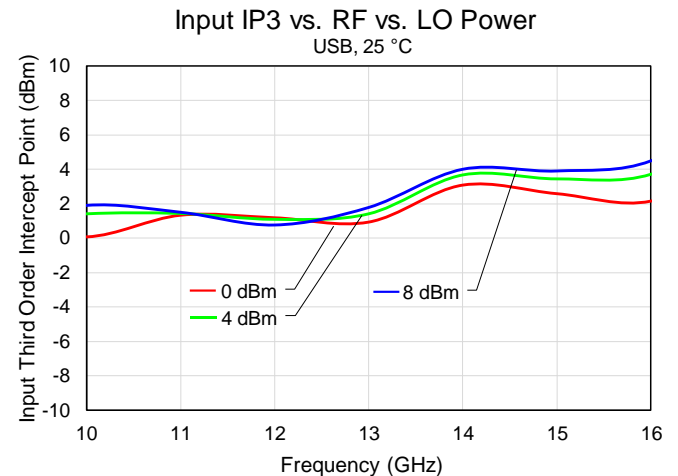
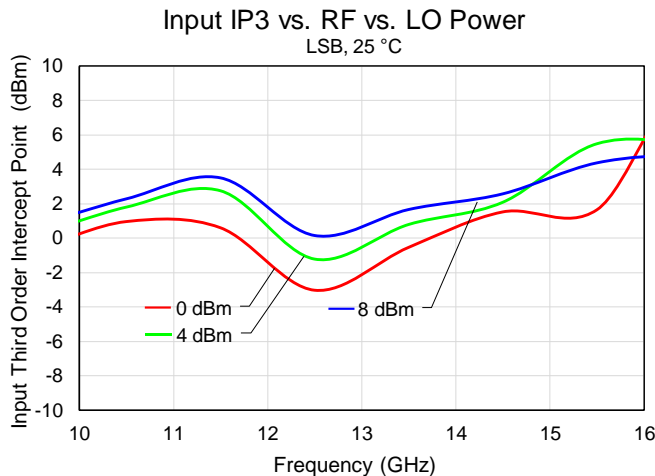
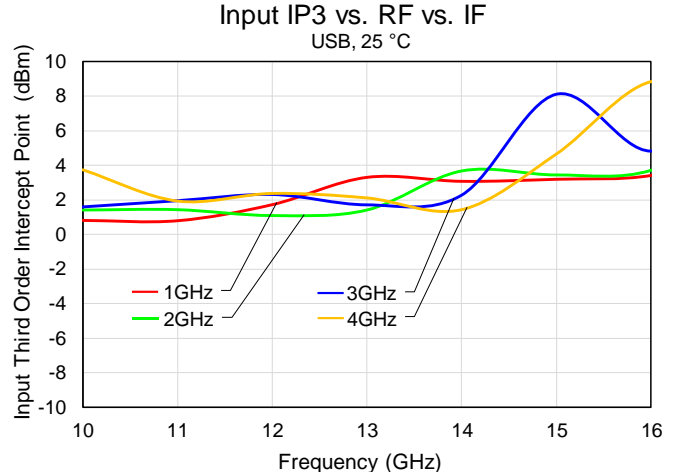
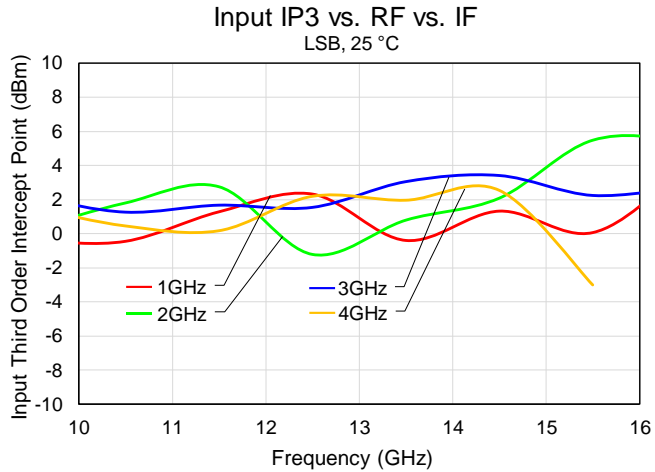

Typical Performance

IF Input Power = -25 dBm, VDLO = 4 V, IDLO = 65 mA, VDRF = 4 V, IDRf = 85 mA.
 Data taken with external IF hybrid.

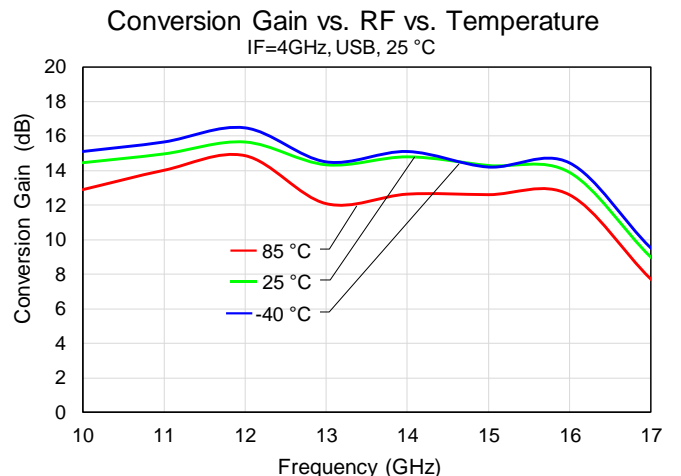
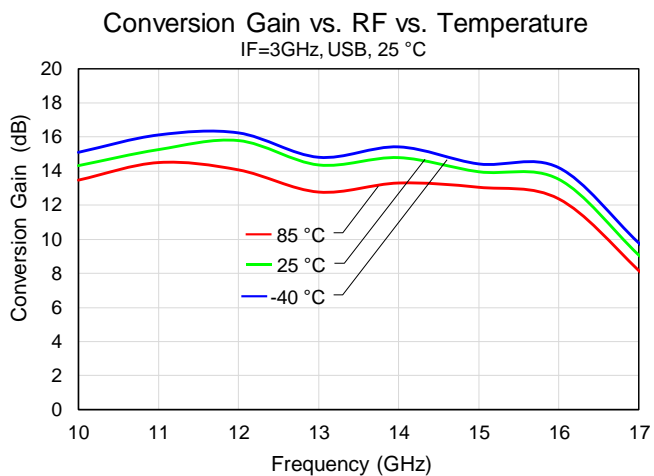
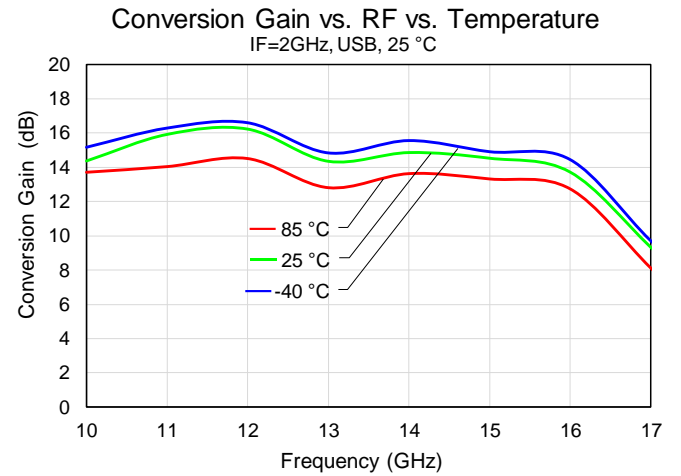
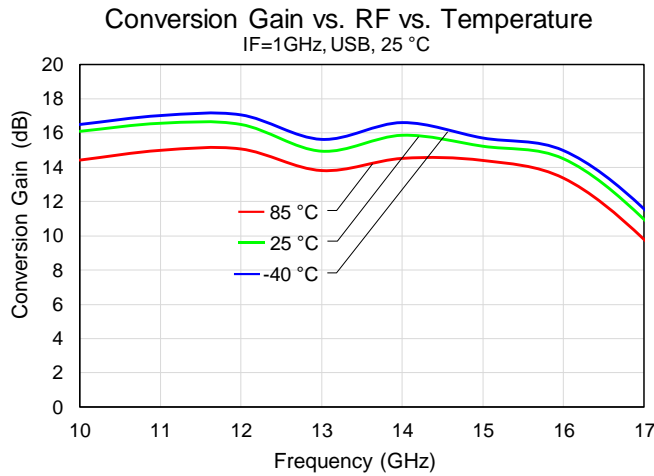
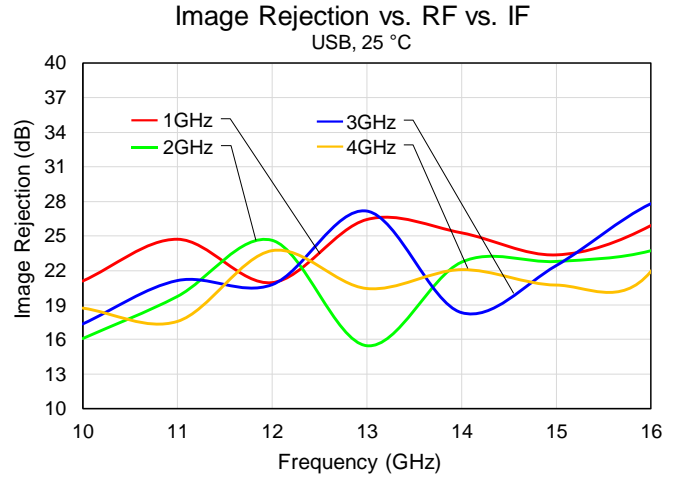
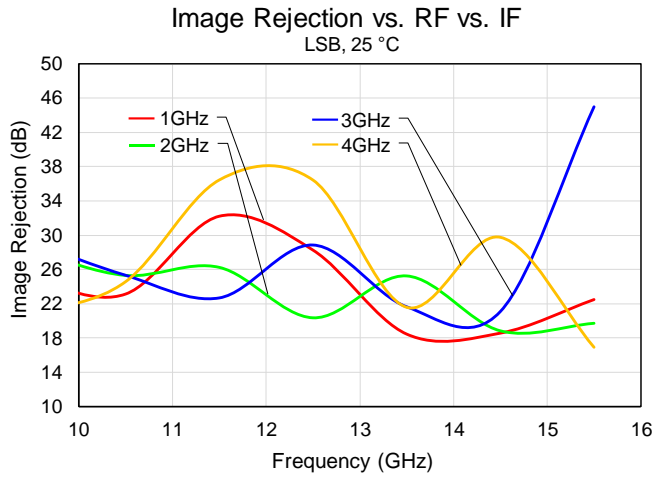

Typical Performance

IF Input Power = -25 dBm, VDLO = 4 V, IDLO = 65 mA, VDRF = 4 V, IDRf = 85 mA.
 Data taken with external IF hybrid.

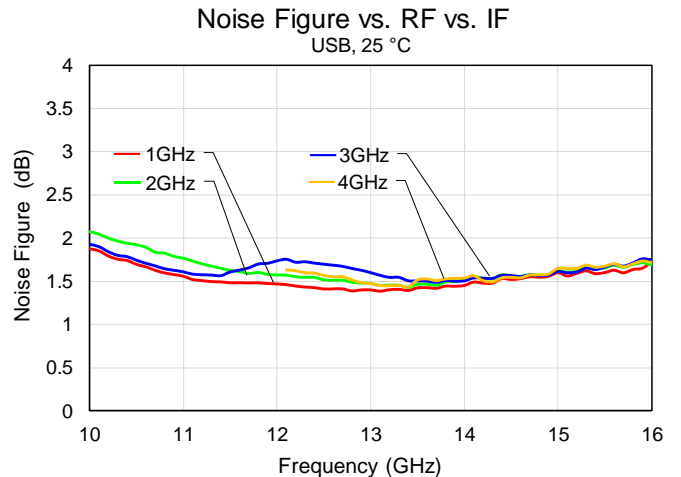
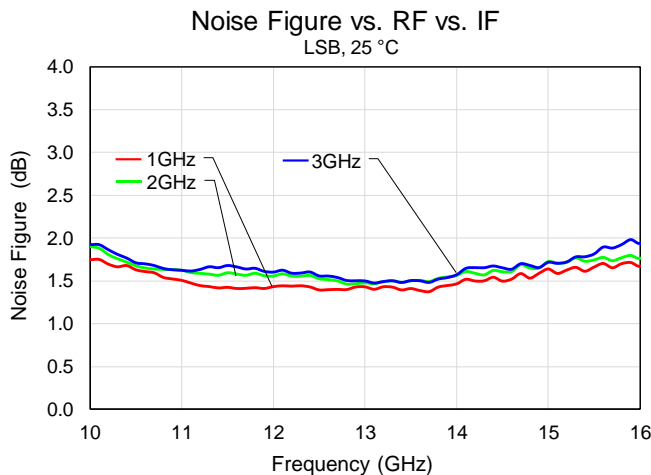
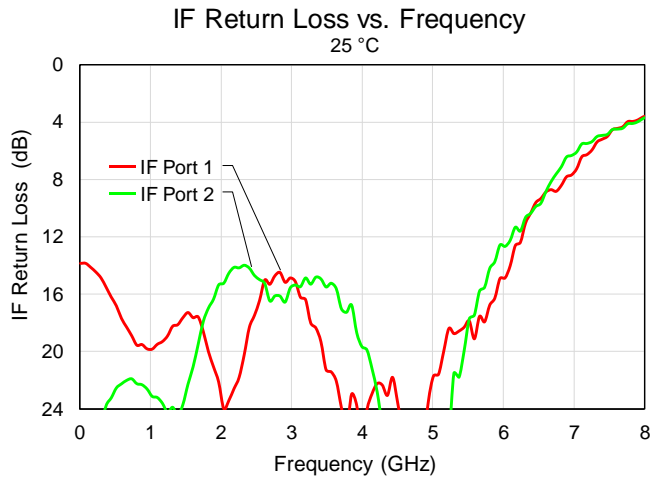
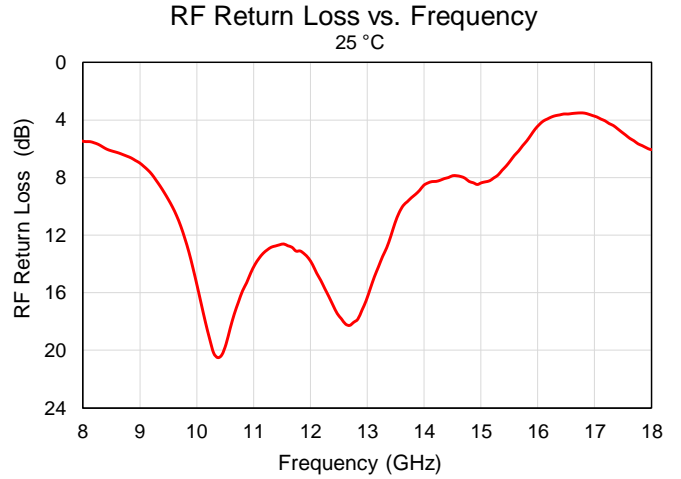
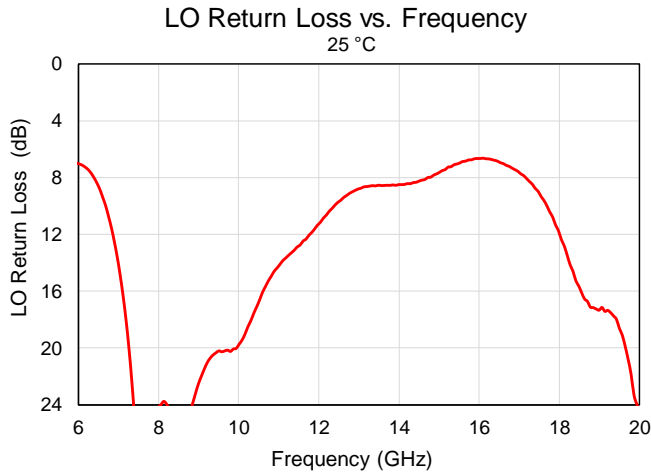

Typical Performance

IF Input Power = -20 dBm, VDLO = 4 V, IDLO = 71 mA, VDRF = 4 V, IDRf = 88 mA, LO Power = 4 dBm.
 Data taken with external IF hybrid.

Spur Tables

Spur tables are $M \times f_{LO} + N \times f_{RF}$ mixer spurious products for -20 dBm RF input power.

Desired IF is at $|1LO - 1RF|$.

All values in dBc below the IF output power level.

M x N Spurious Outputs for LSB, IF = 2.0 GHz

		M x f _{LO}						
		0	1	2	3	4	5	
N x f _{RF}	-5	--	99	99	99	99	99	99
	-4	--	99	99	99	99	99	99
	-3	--	99	61	48	99	99	99
	-2	--	99	33	48	99	99	99
	-1	--	0	35	29	99	99	99
	0	--	17	10	46	99	99	99
	1	15	15	45	53	99	99	99
	2	40	57	53	99	99	99	99
	3	47	52	99	99	99	99	99
	4	53	55	99	99	99	99	99
5	58	99	99	99	99	99	99	

M x N Spurious Outputs for USB, IF = 2.0 GHz

		M x f _{LO}						
		0	1	2	3	4	5	
N x f _{RF}	-5	--	99	99	99	99	99	99
	-4	--	99	99	71	99	99	99
	-3	--	99	99	56	99	99	99
	-2	--	99	38	32	99	99	99
	-1	--	0	21	27	99	99	99
	0	--	11	12	23	99	99	99
	1	12	22	33	45	99	99	99
	2	48	56	55	55	99	99	99
	3	56	52	59	99	99	99	99
	4	54	55	99	99	99	99	99
5	51	99	99	99	99	99	99	

Pin Configuration and Description

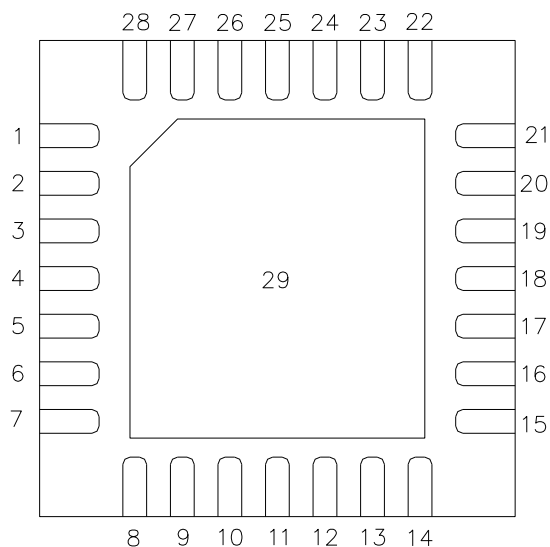

Pin No.	Label	Description
1, 2, 4, 6, 7, 8, 12, 14, 15, 16, 18, 20, 21, 22, 23, 25, 26, 27, 28	GND	Internal Grounding; must be grounded on PCB.
3	RF IN	RF Input matched to 50 ohms, AC Coupled.
5	VGX	Mixer Gate Voltage. Bias network is required; see Application Circuit on page 11 as an example.
9	LO IN	LO Input, matched to 50 ohms, AC coupled.
10, 11	NC	No internal connection; must be grounded on PCB.
13	VDLO	LO Drain Voltage. Bias network is required; see Application Circuit on page 11 as an example.
17	IFOUT_LSB	IF Output matched to 50 ohms, DC coupled.
19	IFOUT_USB	IF Output matched to 50 ohms, DC coupled.
24	VDLNA	LNA Drain Voltage. Bias network is required; see Application Circuit on page 11 as an example.

Application Circuit

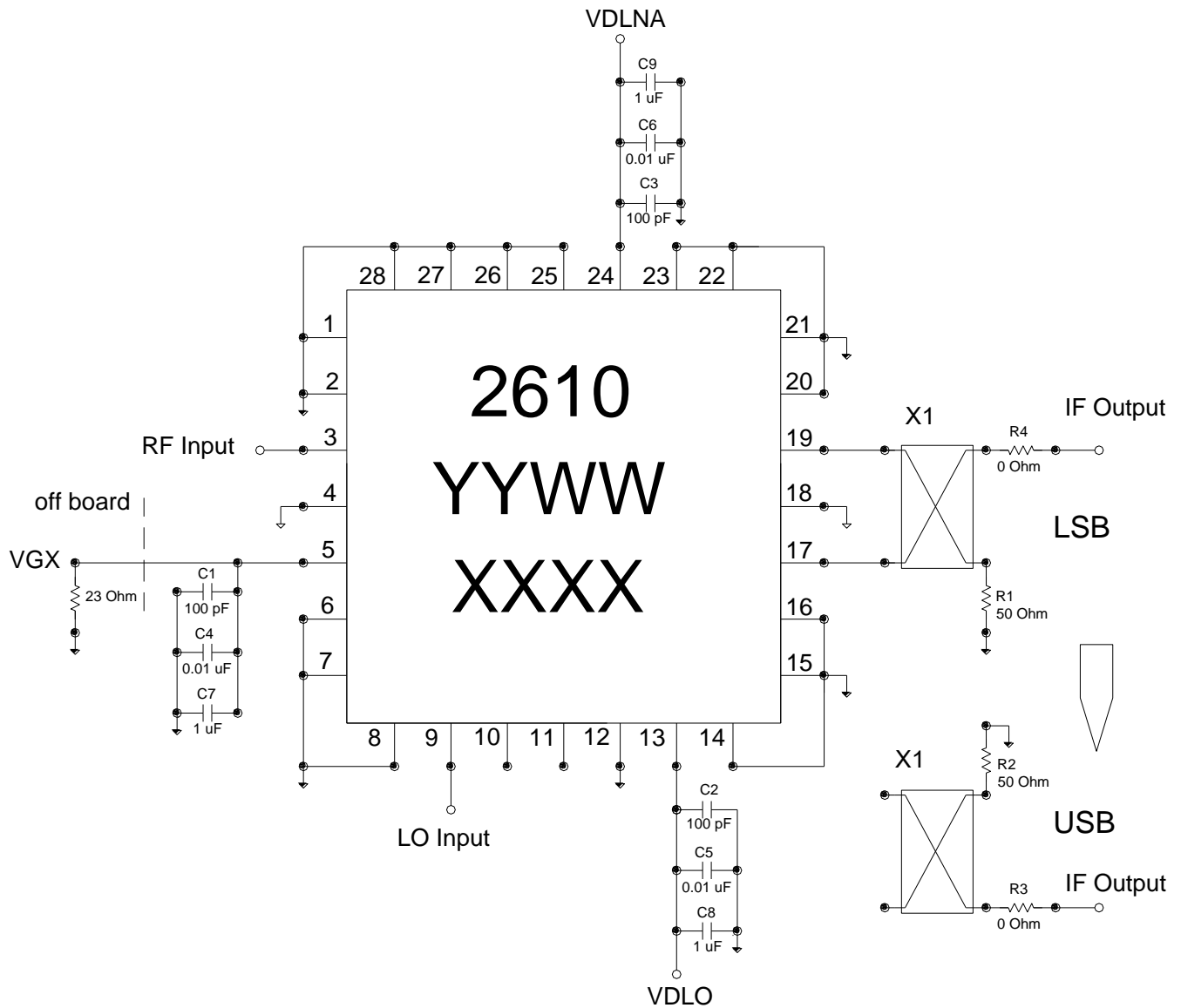

Bias-up Procedure	Bias-down Procedure
Turn VDLO to 4 V	Turn off RF and LO signals
Turn VDLNA to 4 V	Turn VDLNA to 0 V
VGX is connected to 23 ohm resistor to ground	Turn VDLO to 0 V
Apply LO and RF signals	

Application Circuit

PC Board Layout

Board material is RO4003 0.008" thickness with ½ oz copper cladding.
 For further technical information, refer to the [TGC2610-SM](#) Product Information page.

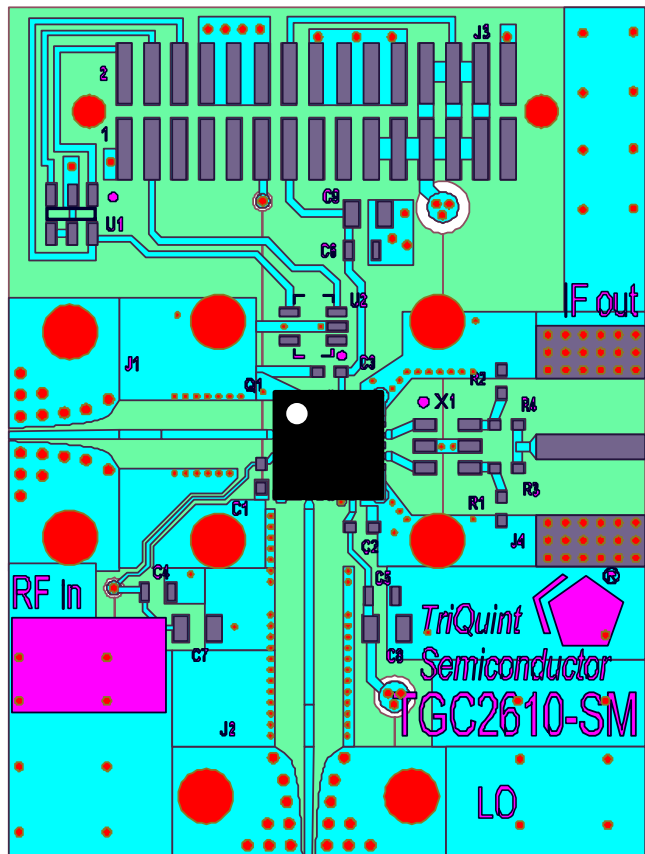

Bill of Material

Ref Des	Value	Description	Manufacturer	Part Number
C1, C2, C3	100 pF	Cap, 0402, 50V, 5%, NPO	various	
C4, C5, C6	0.01 µF	Cap, 0603, 25V, 5%, COG	various	
C7, C8, C9	1 µF	Cap, 0805, 25V, 5%, X5R	various	
U1		Ku-Band Downconverter	TriQuint	TGC2610-SM
LSB Configuration				
R1	50 ohm	Res, 0402, 0.05W, 5%, SMD	various	
R4	0 ohm	Res, 0402, 0.01W, SMD	various	
R2, R3		DNP		
X1		2-Way 90° Power combiner/Splitter	Mini-circuit	QCN-25+ or QCN-45+

Mechanical Information

Package Marking and Dimensions

All dimensions are in millimeters.

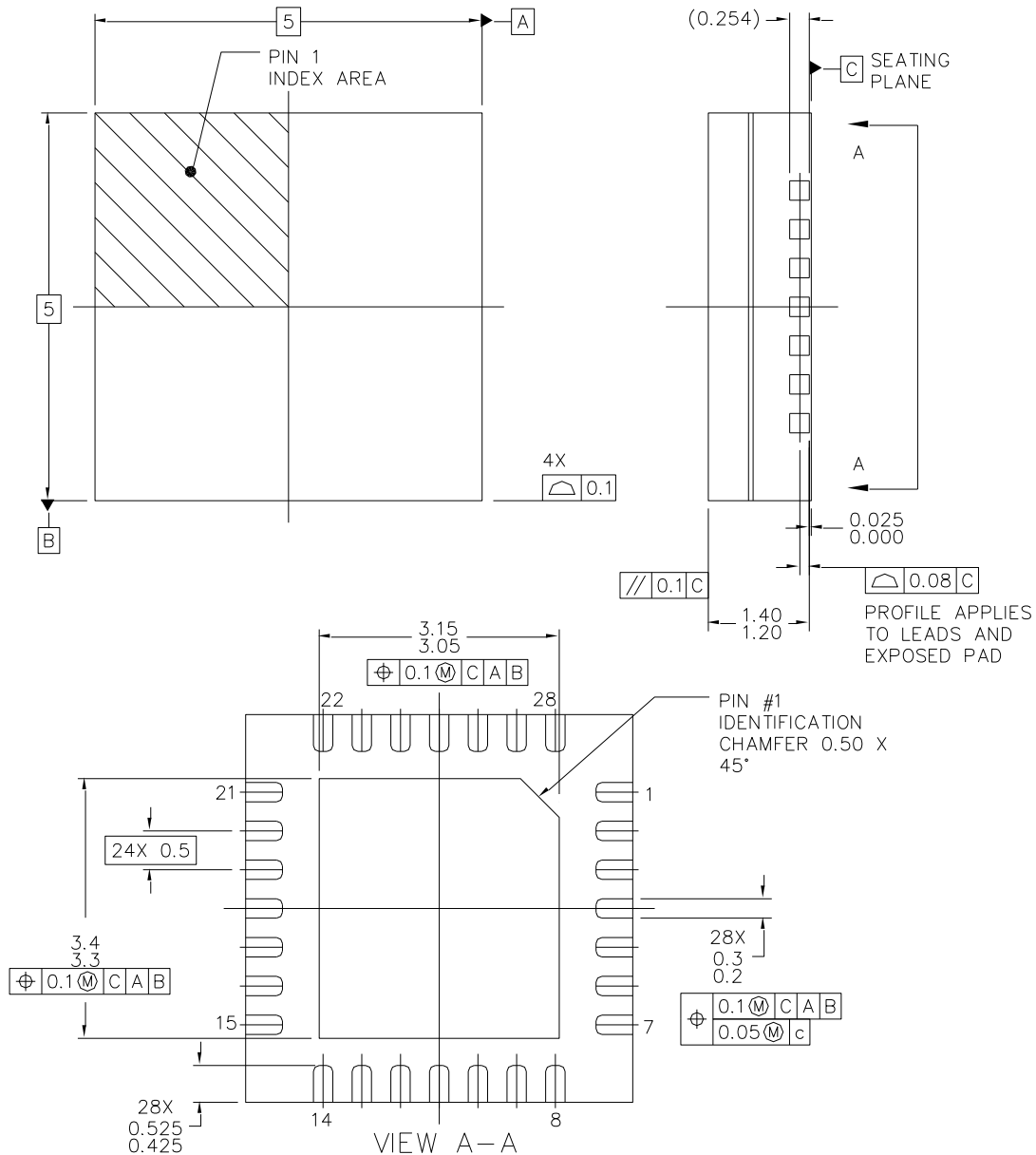

The TGC2610-SM will be marked with the “YYWW” designator and a lot code marked below the part designator. The “YY” represents the last two digits of the year the part was manufactured, the “WW” is the work week, and the “XXXX” is an auto-generated number.

This package is lead-free/RoHS-compliant with a copper alloy base (CDA194), and the plating material on the leads is NiPdAu. It is compatible with a lead-free (maximum 260 °C reflow temperature) soldering process.

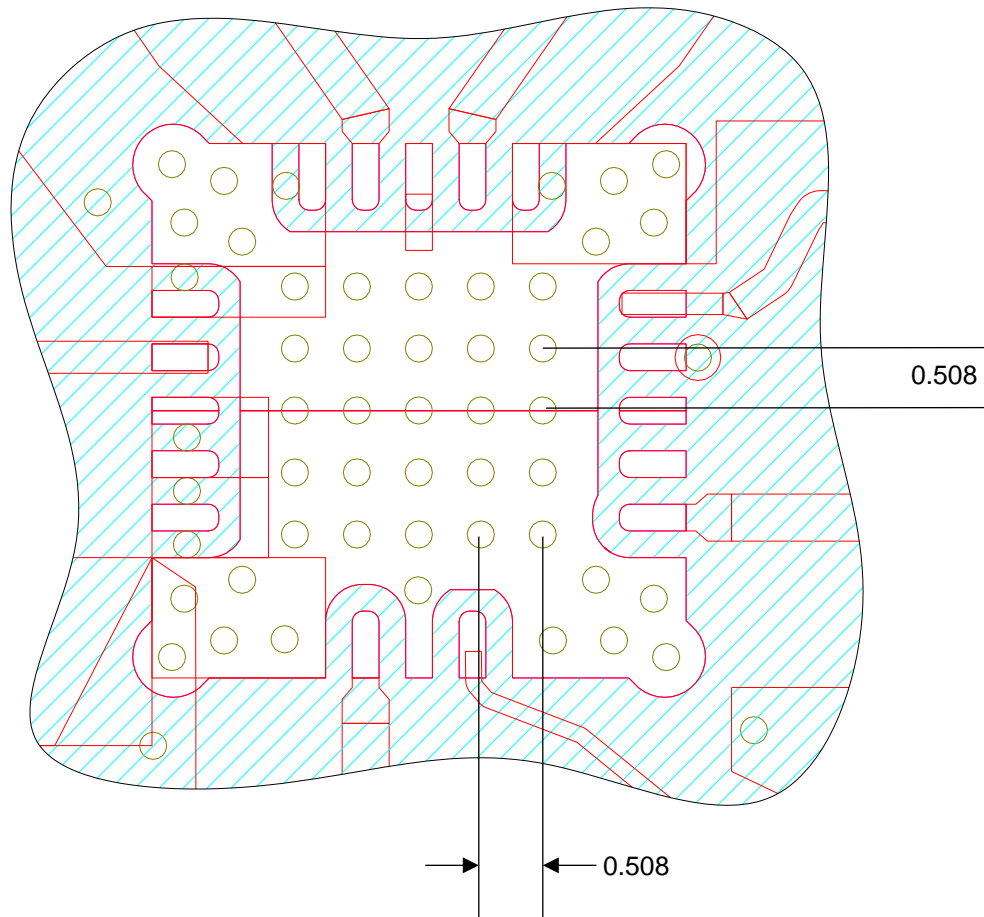
Mechanical Information**PCB Mounting Pattern****Notes:**

1. The pad pattern shown has been developed and tested for optimized assembly at TriQuint Semiconductor. The PCB land pattern has been developed to accommodate lead and package tolerances. Since surface mount processes vary from company to company, careful process development is recommended.
2. Ground vias are critical for the proper performance of this device. Vias should have a final plated thru diameter of .25 mm (.010”).

Tape and Reel Information

Standard T/R size = 500 pieces on a 7" reel.

Material		Cavity (mm)				Distance Between Centerline (mm)		Carrier Tape (mm)	Cover Carrier (mm)
Vendor	Vendor P/N	Length (A0)	Width (B0)	Depth (K0)	Pitch (P1)	Length direction (P2)	Width Direction (F)	Width (W)	Width (W)
Tek-Pak	QFN0500X0 500F-L500	5.3	5.3	1.65	8.0	2.00	5.50	12.0	9.20

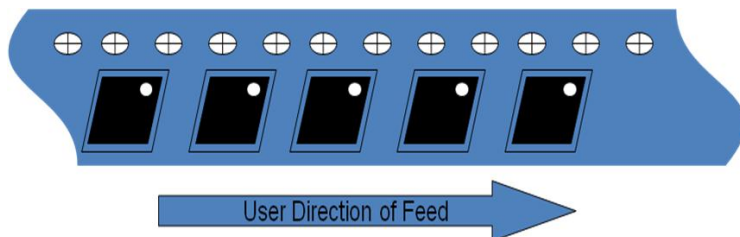
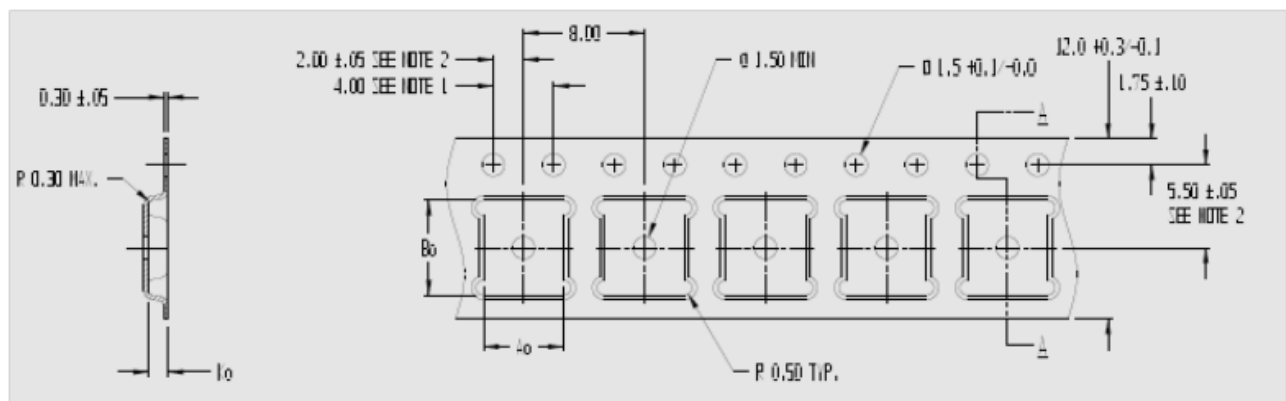

Product Compliance Information

ESD Sensitivity Ratings



Caution! ESD-Sensitive Device

ESD Rating: Class 1B
Value: ≥ 500 V and < 1000 V
Test: Human Body Model (HBM)
Standard: JEDEC Standard JESD22-A114

MSL Rating

MSL Rating: Level 3
Test: 260°C convection reflow
Standard: JEDEC Standard IPC/JEDEC J-STD-020

Solderability

Compatible with lead-free (260°C maximum reflow temperature) soldering processes.

Package lead plating: NiPdAu.

The use of no-clean solder to avoid washing after soldering is recommended.

This package is not compatible with solder containing lead.

RoHS Compliance

This part is compliant with EU 2002/95/EC RoHS directive (Restrictions on the Use of Certain Hazardous Substances in Electrical and Electronic Equipment).

This product also has the following attributes:

- Lead Free
- Halogen Free (Chlorine, Bromine)
- Antimony Free
- TBBP-A (C₁₅H₁₂Br₄O₂) Free
- PFOS Free
- SVHC Free

Recommended Solder Temperature Profile

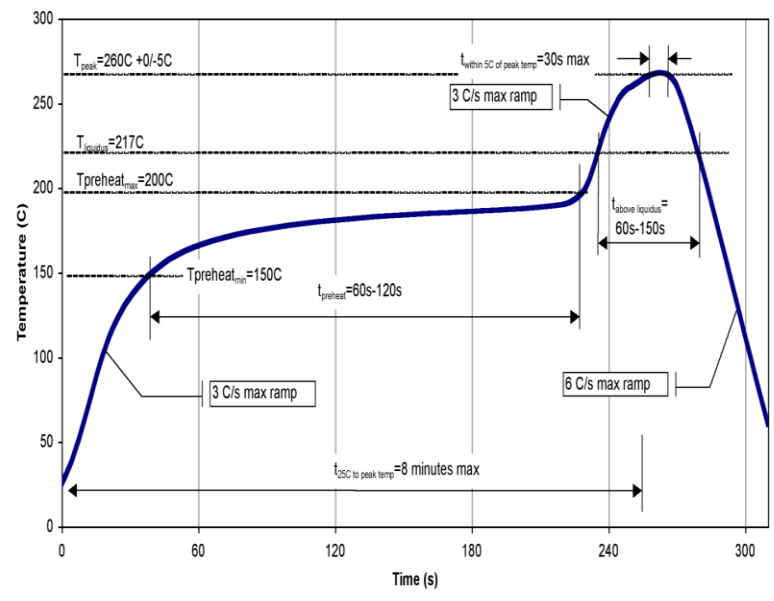

Contact Information

For the latest specifications, additional product information, worldwide sales and distribution locations, and information about TriQuint:

Web: www.triquint.com
Email: info-sales@tqs.com

Tel: +1.972.994.8465
Fax: +1.972.994.8504

For technical questions and application information: **Email:** info-networks@tqs.com

Important Notice

The information contained herein is believed to be reliable. TriQuint makes no warranties regarding the information contained herein. TriQuint assumes no responsibility or liability whatsoever for any of the information contained herein. TriQuint assumes no responsibility or liability whatsoever for the use of the information contained herein. The information contained herein is provided "AS IS, WHERE IS" and with all faults, and the entire risk associated with such information is entirely with the user. All information contained herein is subject to change without notice. Customers should obtain and verify the latest relevant information before placing orders for TriQuint products. The information contained herein or any use of such information does not grant, explicitly or implicitly, to any party any patent rights, licenses, or any other intellectual property rights, whether with regard to such information itself or anything described by such information.

TriQuint products are not warranted or authorized for use as critical components in medical, life-saving, or life-sustaining applications, or other applications where a failure would reasonably be expected to cause severe personal injury or death.