

## Features

- Small Size, Low Profile
- Superior Repeatability (Lot-to-Lot Variation)
- Typical Isolation 25 dB
- Typical Insertion Loss 0.8 dB
- Low Cost
- SOIC-16 Package

## Description

M/A-COM's DS56-0005 is an IC-based monolithic power divider in a low cost SOIC-16 plastic package. The 6-way power divider is ideally suited for applications where PCB real estate is at a premium and part count reduction and cost are critical. Typical applications include base station switching networks and other cellular equipment, including subscriber units. Available in Tape and Reel.

The DS56-0005 is fabricated using a passive-integrated circuit process. The process features full-chip passivation for increased performance and reliability.

## Functional Block Diagram<sup>1</sup>

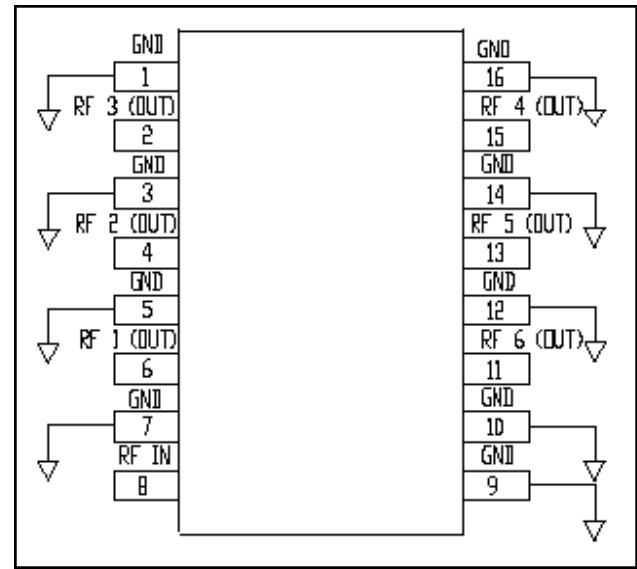

1. All unused pins must be RF and DC grounded.

## Ordering Information

Part Number	Package
DS56-0005	Bulk Packaging
DS56-0005-TR	1000 piece reel

Note: Reference Application Note M513 for reel size information.

## Pin Configuration

Pin No.	Function	Pin No.	Function
1	GND	9	GND
2	RF 3 (OUT)	10	GND
3	GND	11	RF 6 (OUT)
4	RF 2 (OUT)	12	GND
5	GND	13	RF 5 (OUT)
6	RF 1 (OUT)	14	GND
7	GND	15	RF 4 (OUT)
8	RF IN	16	GND

## Electrical Specifications: $T_A = 25^\circ\text{C}$ , $Z_0 = 50\Omega$

Parameter	Units	Min	Typ	Max
Insertion Loss above 7.8 dB	dB	—	0.8	1.2
Isolation	dB	20	25	—
VSWR Input	—	—	1.4:1	1.8:1
Output	—	—	1.3:1	1.5:1
Amplitude Balance	dB	—	0.5	0.9
Phase Balance	Deg.	—	4	8

## Absolute Maximum Ratings <sup>2,3</sup>

Parameter	Absolute Maximum
Input Power <sup>4</sup>	1 W CW
Operating Temperature	-40°C to +85°C
Storage Temperature	-65°C to +150°C

- Exceeding any one or combination of these limits may cause permanent damage to this device.
- M/A-COM does not recommend sustained operation near these survivability limits.
- With internal load dissipation of 0.125 W maximum.

## Handling Procedures

Please observe the following precautions to avoid damage:

## Static Sensitivity

GMIC Circuits are sensitive to electrostatic discharge (ESD) and can be damaged by static electricity. Proper ESD control techniques should be used when handling these devices.

## Typical Performance Curves

Insertion Loss vs. Frequency

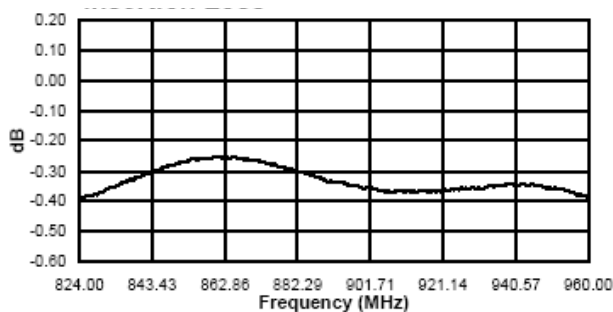

Amplitude Imbalance vs. Frequency

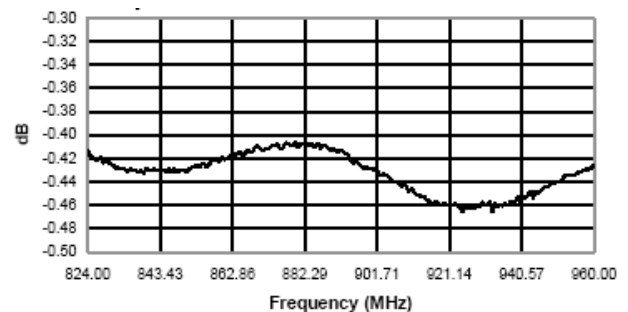

## Typical Performance Curves

*Isolation vs. Frequency*

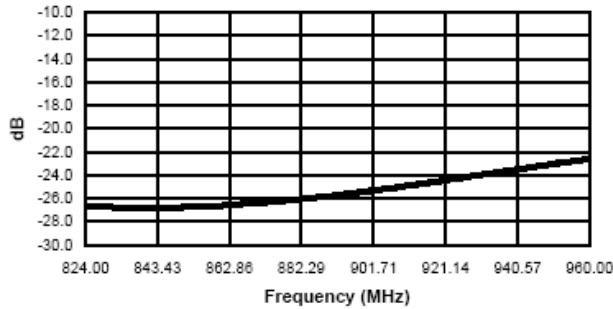

*Phase Imbalance vs. Frequency*

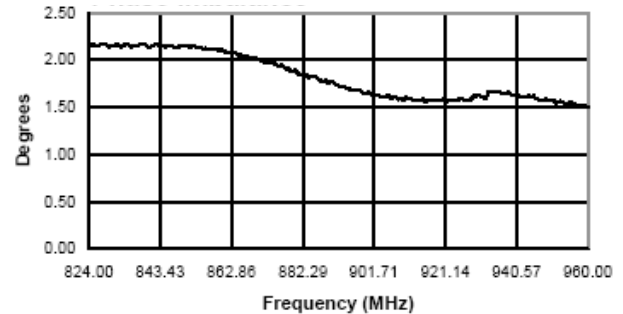

*Input VSWR vs. Frequency*

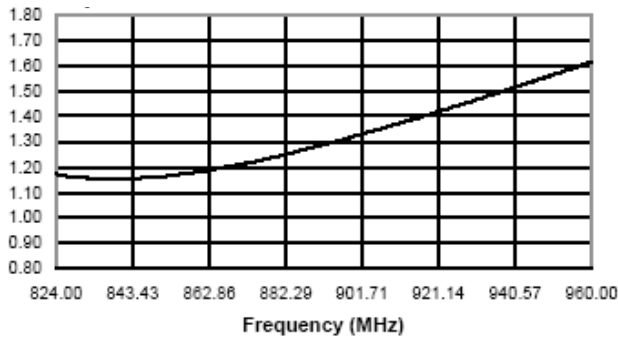

*Output VSWR vs. Frequency*

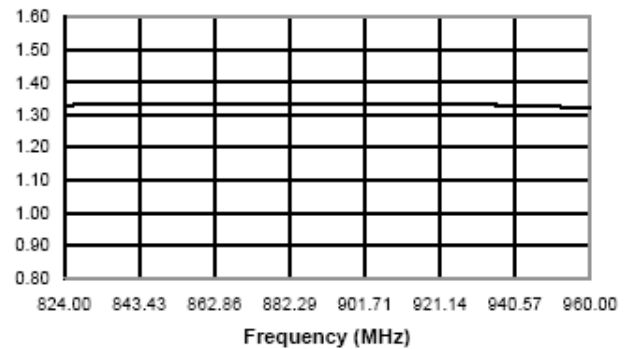

# DS56-0005

## Low Cost Six-Way Power Divider 824 – 960 MHz

Rev. V4

### SOIC-16<sup>†</sup>

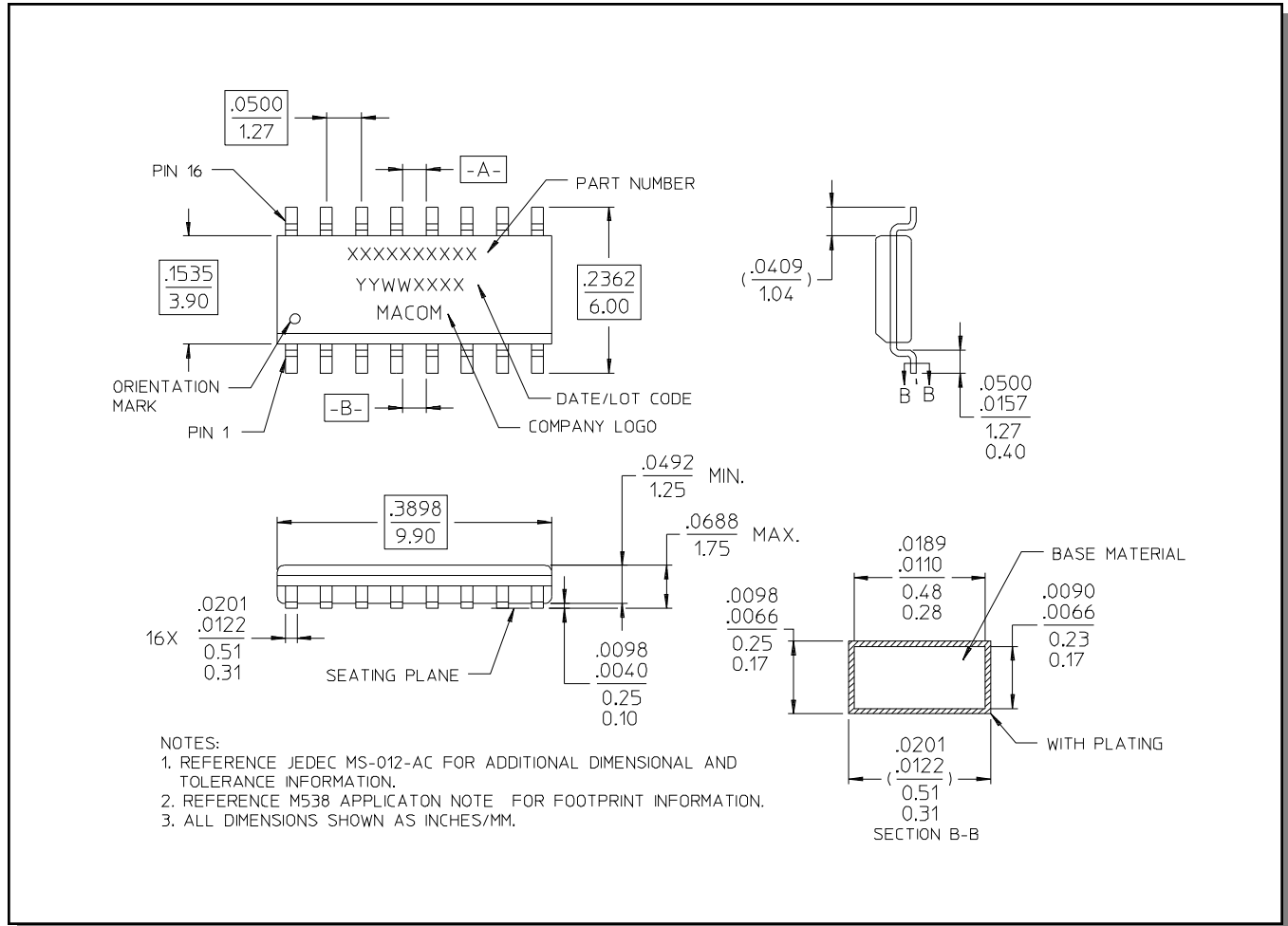

<sup>†</sup> Reference Application Note M538 for lead-free solder reflow recommendations.