

SC-GU2-C

Related Information

- General terms and conditions..... F-7
- FX-500 / FX-300 P.73~ / P.139~
- LS-500 / LS-400 / DPS-400 P.241~ / P.253~ / P.767~
- General precautions P.1501

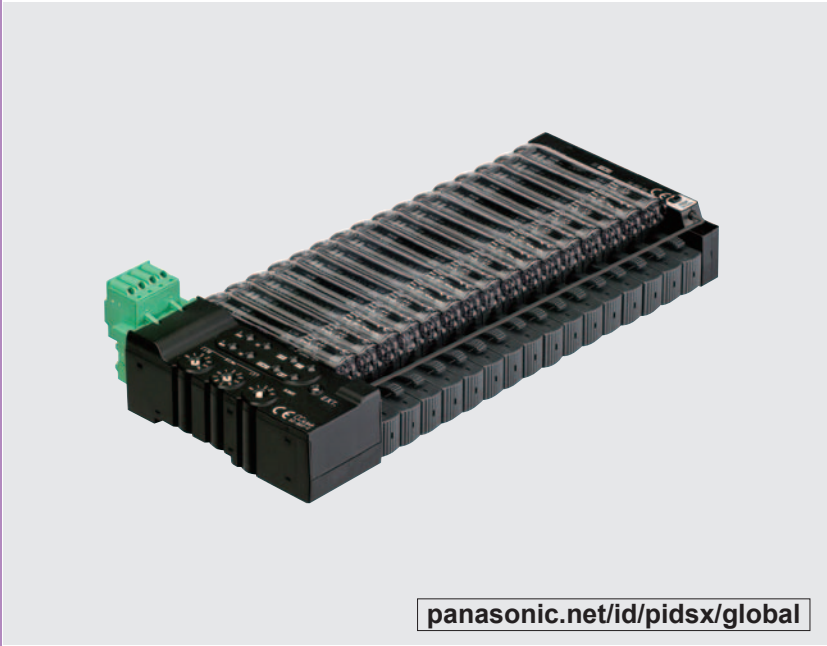

Contributes to wire-saving, construction-saving, traceability, preventive maintenance, and more

To minimize life cycle cost

As the life cycle of equipment shortens year by year, controlling the cost at manufacturing or during usage has become an important subject. Panasonic Industrial Devices SUNX uses the communication unit for CC-Link **SC-GU2-C**, which makes the most use of open network for efficient and preventive maintenance as well as wire-saving and construction-saving. Here is the solution for minimizing cost related to life cycle in equipment.



Minimizing Life Cycle Cost

- FIBER SENSORS
- LASER SENSORS
- PHOTOELECTRIC SENSORS
- MICRO PHOTOELECTRIC SENSORS
- AREA SENSORS
- LIGHT CURTAINS / SAFETY COMPONENTS
- PRESSURE / FLOW SENSORS
- INDUCTIVE PROXIMITY SENSORS
- PARTICULAR USE SENSORS
- SENSOR OPTIONS
- SIMPLE WIRE-SAVING UNITS**
- WIRE-SAVING SYSTEMS
- MEASUREMENT SENSORS
- STATIC ELECTRICITY PREVENTION DEVICES
- LASER MARKERS
- PLC
- HUMAN MACHINE INTERFACES
- ENERGY CONSUMPTION VISUALIZATION COMPONENTS
- FA COMPONENTS
- MACHINE VISION SYSTEMS
- UV CURING SYSTEMS

- Upper Communication Unit
- MIL Connector Plug-in
- SC-GU3
- SC-GU2-C**
- SC-GU1-485

Traceability

By keeping track of the sensor configurations at equipment start-up, any failure that may occur after equipment delivery can be eliminated in early stages.

Before When a failure occurs

It is hard to identify as to what went wrong. Great numbers of man-hours are taken to check on the setting of each sensor one by one.

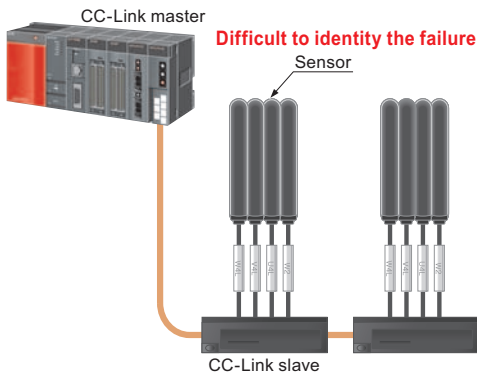

After When a failure occurs

It is easy to identify as to what went wrong. By having the information of each sensor saved as "Configuration file", traceability is improved, and incorrect input or setting loss can be prevented.

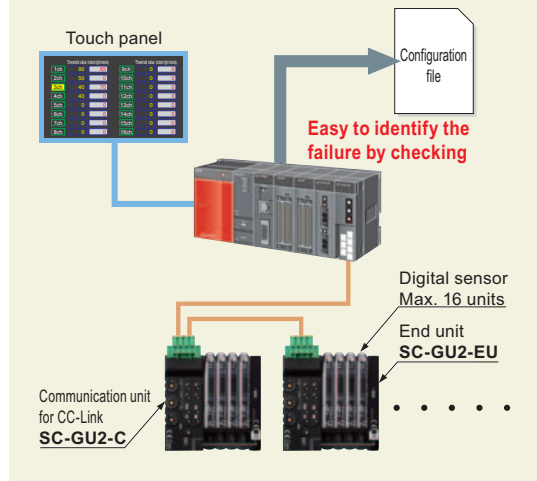

* Maximum of 12 units including the FX-500 series can communicate optically.

Remote monitoring of equipment

It is possible to check the sensor configurations through open network when a failure occurs in the equipment or production line, so that the on-site man-hours taken can be kept to the minimum.

Before Current situation

Confirm on sensor condition via telephone or e-mail.



It takes time to confirm the configuration condition.

Worst comes worst, a trip down to the actual worksite is needed.

After Adopting communication

Monitoring can be done via existing system or PC. Actions can be taken correctly and swiftly with accurate situations on hand.

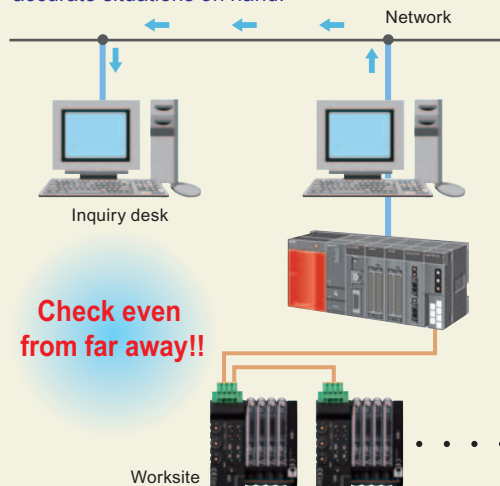

FIBER SENSORS

LASER SENSORS

PHOTOELECTRIC SENSORS

MICRO PHOTOELECTRIC SENSORS

AREA SENSORS

LIGHT CURTAINS / SAFETY COMPONENTS

PRESSURE / FLOW SENSORS

INDUCTIVE PROXIMITY SENSORS

PARTICULAR USE SENSORS

SENSOR OPTIONS

SIMPLE WIRE-SAVING UNITS

WIRE-SAVING SYSTEMS

MEASUREMENT SENSORS

STATIC ELECTRICITY PREVENTION DEVICES

LASER MARKERS

PLC

HUMAN MACHINE INTERFACES

ENERGY CONSUMPTION VISUALIZATION COMPONENTS

FA COMPONENTS

MACHINE VISION SYSTEMS

UV CURING SYSTEMS

Upper Communication Unit MIL Connector Plug-in

SC-GU3

SC-GU2-C

SC-GU1-485

- FIBER SENSORS
- LASER SENSORS
- PHOTOELECTRIC SENSORS
- MICRO PHOTOELECTRIC SENSORS
- AREA SENSORS
- LIGHT CURTAINS / SAFETY COMPONENTS
- PRESSURE / FLOW SENSORS
- INDUCTIVE PROXIMITY SENSORS
- PARTICULAR USE SENSORS
- SENSOR OPTIONS
- SIMPLE WIRE-SAVING UNITS**
- WIRE-SAVING SYSTEMS
- MEASUREMENT SENSORS
- STATIC ELECTRICITY PREVENTION DEVICES
- LASER MARKERS
- PLC
- HUMAN MACHINE INTERFACES
- ENERGY CONSUMPTION VISUALIZATION COMPONENTS
- FA COMPONENTS
- MACHINE VISION SYSTEMS
- UV CURING SYSTEMS

Highly efficient maintenance

By having the configurations saved as “Configuration file” before equipment shipment, later on when it comes to exchanging the sensors, the configurations can be simply written in to CC-Link. Also, exchanges can be done easily with connection connectors without any extra tools.

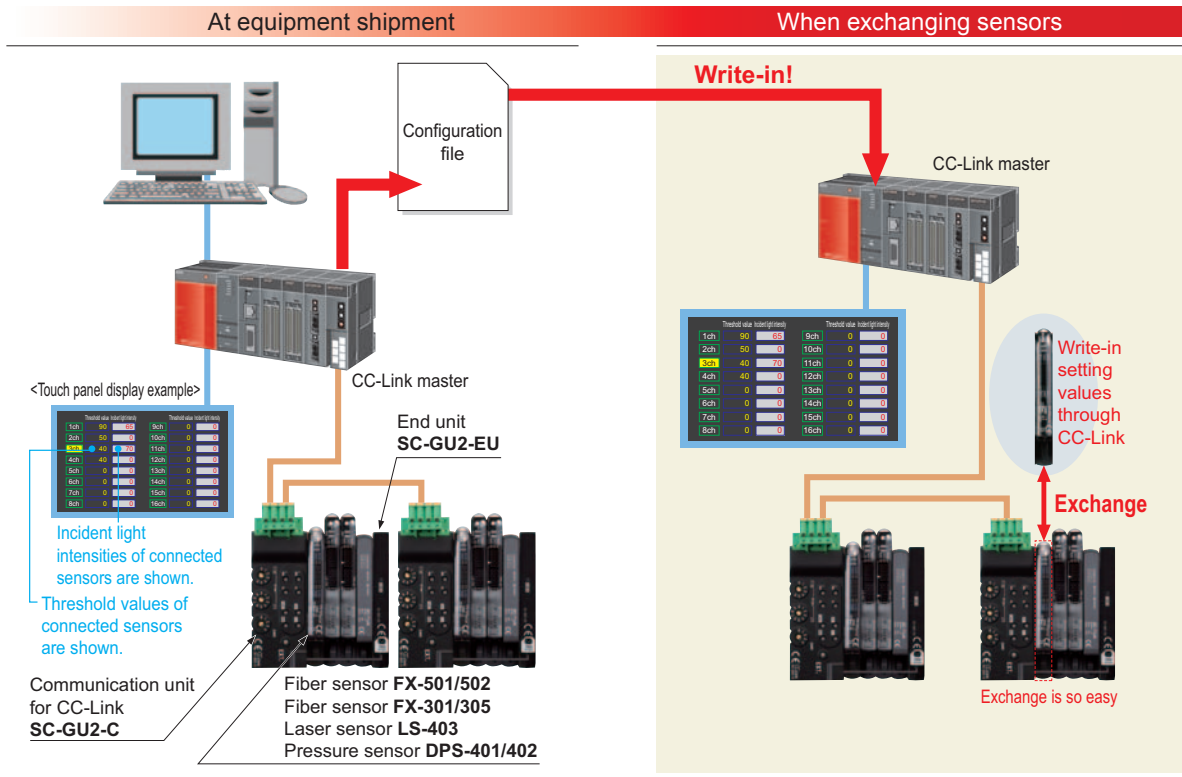

Preventive maintenance

Take in digital data such as incident light intensity or pressure value of sensors and graph them out for preventive maintenance.
(e.g.) Light attenuated due to dirt on fiber sensor.

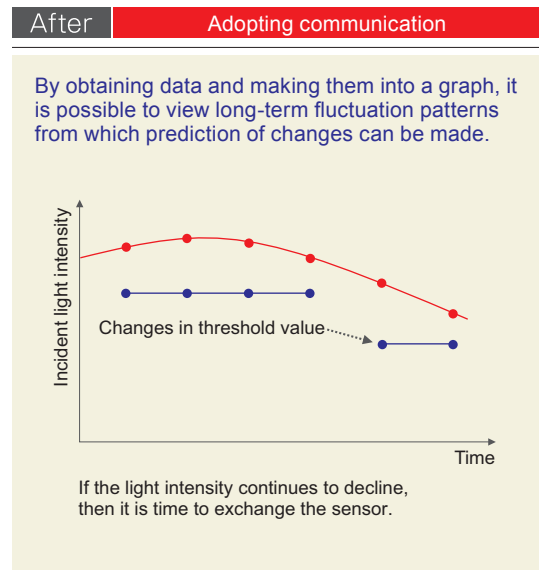
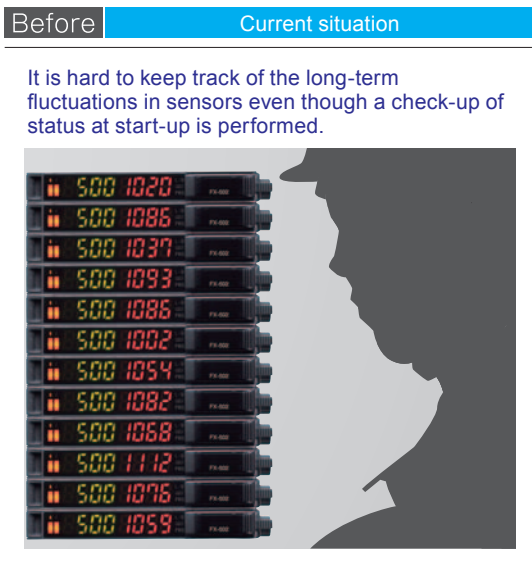

* To make a graph, it is necessary to compose a ladder separately.

Easy maintenance with the memory function

Settings of the connected digital sensors are stored in the **SC-GU2-C**. Setting data can be transmitted and restored to original status by just pressing the "Setting extension (EXT.)" key. Maintenance such as sensor replacement, etc., can be performed smoothly. It will also automatically check the settings stored in the **SC-GU2-C** and the settings for the digital sensor when the power is turned on. When the setting is different, memory function indicator will flash, and warning signal can be sent, preventing the equipment operating with settings changed.

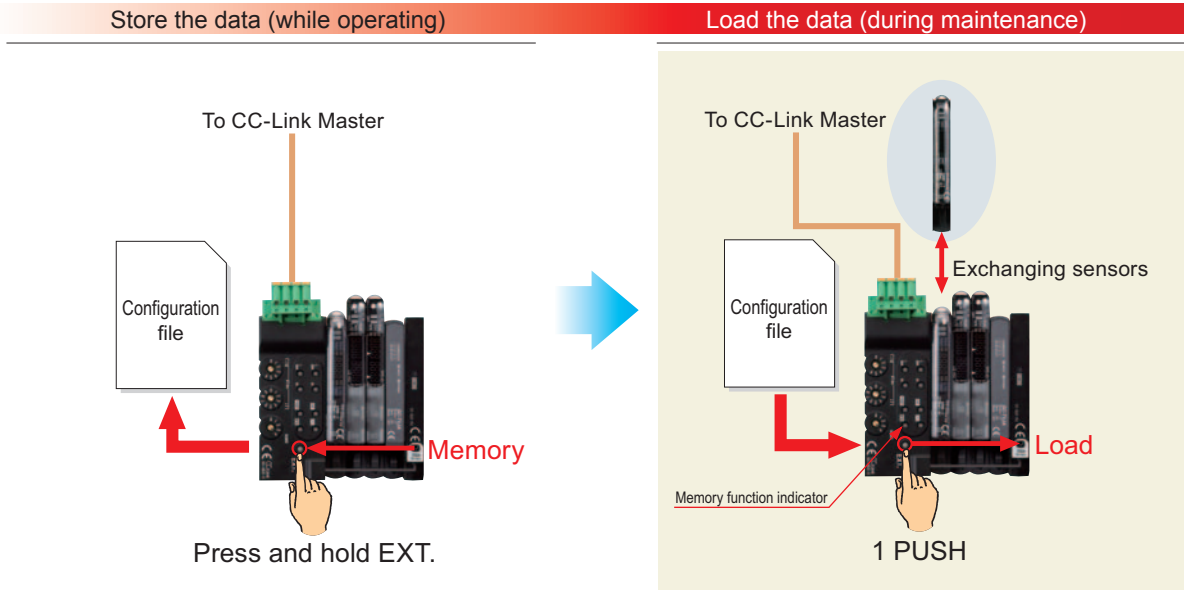

* Memory function can be utilized with CC-Link communication by setting the flag in the remote register.

Reduction of wiring, construction and space

Space for installing a CC-Link slave is eliminated. Cascade connection is simply done by connectors so that the time taken for wiring and construction can be cut down.

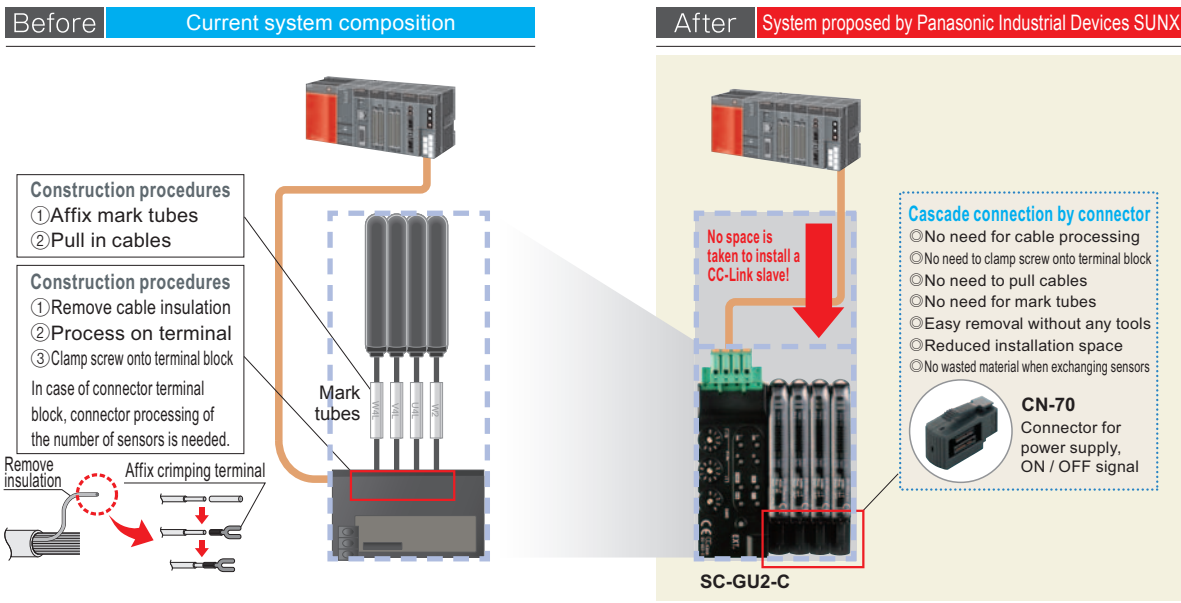

FIBER SENSORS

LASER SENSORS

PHOTOELECTRIC SENSORS

MICRO PHOTOELECTRIC SENSORS

AREA SENSORS

LIGHT CURTAINS / SAFETY COMPONENTS

PRESSURE / FLOW SENSORS

INDUCTIVE PROXIMITY SENSORS

PARTICULAR USE SENSORS

SENSOR OPTIONS

SIMPLE WIRE-SAVING UNITS

WIRE-SAVING SYSTEMS

MEASUREMENT SENSORS

STATIC ELECTRICITY PREVENTION DEVICES

LASER MARKERS

PLC

HUMAN MACHINE INTERFACES

ENERGY CONSUMPTION VISUALIZATION COMPONENTS

FA COMPONENTS

MACHINE VISION SYSTEMS

UV CURING SYSTEMS

Upper Communication Unit MIL Connector Plug-in

SC-GU3

SC-GU2-C

SC-GU1-485

- FIBER SENSORS
- LASER SENSORS
- PHOTOELECTRIC SENSORS
- MICRO PHOTOELECTRIC SENSORS
- AREA SENSORS
- LIGHT CURTAINS / SAFETY COMPONENTS
- PRESSURE / FLOW SENSORS
- INDUCTIVE PROXIMITY SENSORS
- PARTICULAR USE SENSORS
- SENSOR OPTIONS
- SIMPLE WIRE-SAVING UNITS
- WIRE-SAVING SYSTEMS
- MEASUREMENT SENSORS
- STATIC ELECTRICITY PREVENTION DEVICES
- LASER MARKERS
- PLC
- HUMAN MACHINE INTERFACES
- ENERGY CONSUMPTION VISUALIZATION COMPONENTS
- FA COMPONENTS
- MACHINE VISION SYSTEMS
- UV CURING SYSTEMS
- Upper Communication Unit
- MIL Connector Plug-in
- SC-GU3**
- SC-GU2-C**
- SC-GU1-485

Space saving with open unit setting

When you like to perform the process for every 1 byte (sensor input: For 8 units) to make the data control clear, of if you are planning to add sensors later, it is possible to set the open unit (sensor). Also with the conventional remote I/O, you needed installation space for 16 units, but this can save the installation space to minimum.

Example: To divide 16 units to every 8 units, and create open unit for 3 units each

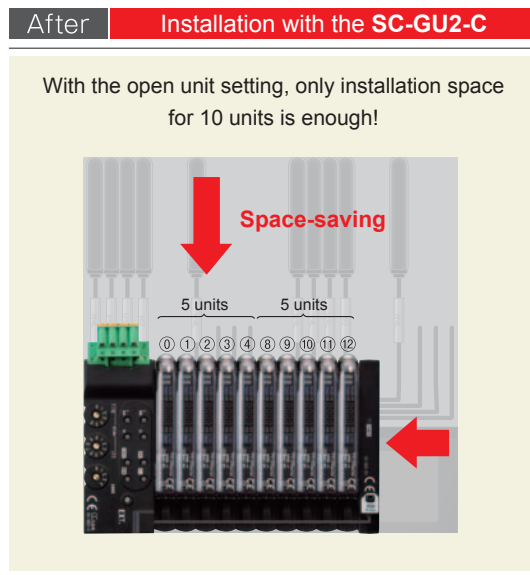
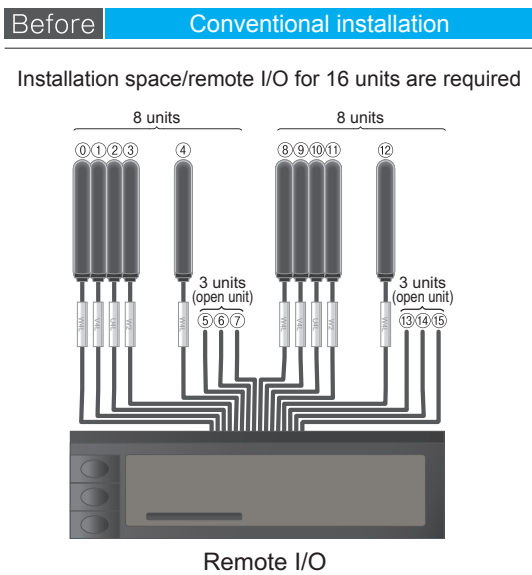

* It will be set to open unit by setting the RX to "0" and RY to "1" on the remote register with same address.

Make use of spare channels

For sensors that cannot connect in cascade, connect a connector input extension unit **SC-T1JA**, **SC-T1J**, **SC-T8J** / a connector I/O mixed extension unit **SC-TP8J** to **SC-GU2-C** to enable cascade connection to save more wiring. **SC-T1JA** can also connect with sensors of analog input (1 to 5 V).

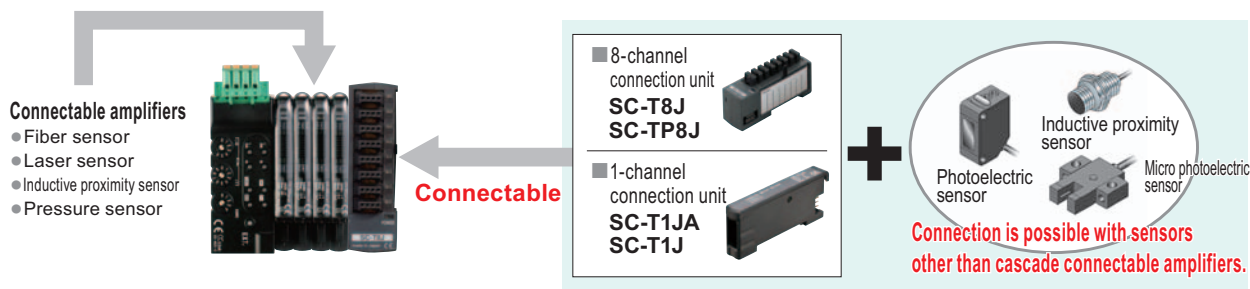

Distributed installation is possible

Distributed installation of sensors is possible by using the plug-in sensor separate unit **SC-MIL-S** / sensor main unit **SC-MIL**. (However, only input for Output 1 (ON/OFF) can communicate. (Output 2 cannot be input.) Also, optical communication of current data and threshold value setting etc. are not possible.)

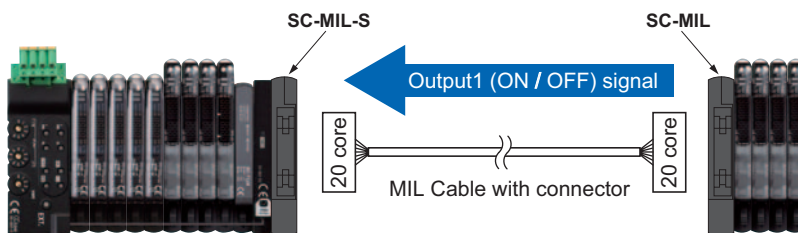

SYSTEM COMPOSITION

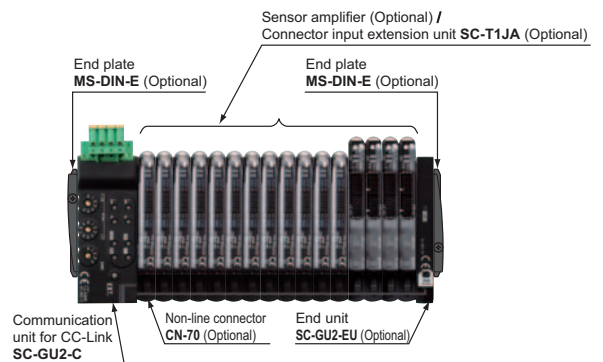
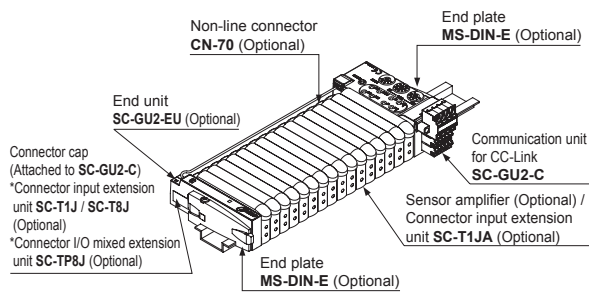

* The **SC-T1J/T8J/TP8J** is positioned on the outside of the end unit.

Transmits ON / OFF signal only.

Does not respond to data communication.

ORDER GUIDE

Communication units

Designation	Appearance	Model No.	Description
Communication unit for CC-Link		SC-GU2-C	This is a communication unit, which can convert the output signal of a sensor amplifier into communication data for CC-Link.
End unit		SC-GU2-EU	This end unit can change and check the settings of sensor amplifiers that allow optical communication and monitor operation status.

Connector input extension units

Designation	Appearance	Model No.	Description
1-channel connector input extension unit		SC-T1JA	This product can be connected with input devices such as sensors and switches. Also, the product can monitor by using 1 to 5 V analog voltage output, which is outputted by the input devices. * When communicating the converted value from analog to digital, the end unit SC-GU2-EU should be used.
		SC-T1J	Allows the connection of input device, such as sensor or switch. Incorporates a power indicator and an input signal indicator (1 ch).
8-channel connector input extension unit		SC-T8J	Allows the connection of input devices, such as sensors or switches. Incorporates a power indicator and input signal indicators (8 ch).
8-channel connector I/O mixed extension unit		SC-TP8J	Allows the connection of a variety of input and output devices. This unit does not contain input / output signal indicators.

Plug-in sensor units (MIL connectors)

Designation	Appearance	Model No.	Description
Plug-in sensor separate unit		SC-MIL-S	Distributed installation by the MIL connector is possible by combining the plug-in sensor separate unit SC-MIL-S and the plug-in sensor main unit SC-MIL .
Plug-in sensor main unit		SC-MIL	

FIBER SENSORS

LASER SENSORS

PHOTO-ELECTRIC SENSORS

MICRO PHOTO-ELECTRIC SENSORS

AREA SENSORS

LIGHT CURTAINS / SAFETY COMPONENTS

PRESSURE / FLOW SENSORS

INDUCTIVE PROXIMITY SENSORS

PARTICULAR USE SENSORS

SENSOR OPTIONS

SIMPLE WIRE-SAVING UNITS

WIRE-SAVING SYSTEMS

MEASUREMENT SENSORS

STATIC ELECTRICITY PREVENTION DEVICES

LASER MARKERS

PLC

HUMAN MACHINE INTERFACES

ENERGY CONSUMPTION VISUALIZATION COMPONENTS

FA COMPONENTS

MACHINE VISION SYSTEMS

UV CURING SYSTEMS

Upper Communication Unit
MIL Connector Plug-in



SC-GU3

SC-GU2-C

SC-GU1-485



ORDER GUIDE

Optical communication compatible amplifier

Type		Appearance	Model No.	Combined head	Description
Digital fiber sensor	FX-500 series	Standard type	FX-501	FT-□ FD-□	NPN open-collector transistor
		Two outputs type	FX-502		NPN open-collector transistor two outputs (Note)
	FX-300 series	Standard type	FX-301		NPN open-collector transistor
		High functionality type	FX-305		NPN open-collector transistor two outputs (Note)
Digital laser sensor			LS-501	LS-H□	NPN open-collector transistor
			LS-403		
Digital pressure sensor	For combined pressure / negative pressure		DPS-401	DPH-101□ DPH-103□	NPN open-collector transistor two outputs (Note)
			DPS-402	DPH-102□	



Note: To receive the output signal from the Output 2, it is required to perform optical communication by simultaneously using the end unit **SC-GU2-EU**.

Options

Designation	Appearance	Model No.	Description
Non-line connector		CN-70	This one-touch connector is used to connect the following devices to SC-GU2-C : The FX-500/300/311/400 fiber sensor, the LS-401/403 laser sensor, digital pressure sensor DPS-401/402 , the GA-311 compact inductive proximity sensor, etc.
End plate (Note)		MS-DIN-E	After installing SC-GU2-C , sensor amplifier, SC-GU2-EU etc. in cascade on a DIN rail, these end plates clamp the units into place on both sides. Be sure to use this product. Two pcs. per set

Note: Commercially available DIN rail stopper can also be used.

Others

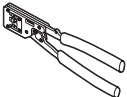
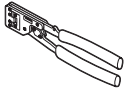
Designation	Appearance	Model No.	Description
4-pin type snap male connector		SL-CP1 (White) 10 pcs. per set	For 0.08 to 0.2 mm ² (Conductor cross-section area) Wire dia.: ø0.7 to ø1.2 mm ø0.028 to ø0.047 in
		SL-CP2 (Black) 10 pcs. per set	For 0.3 mm ² (Conductor cross-section area) Wire dia.: ø1.1 to ø1.6 mm ø0.043 to ø0.063 in
		SL-CP3 (Greenish blue) 10 pcs. per set	For 0.5 mm ² (Conductor cross-section area) Wire dia.: ø1.7 to ø2.5 mm ø0.067 to ø0.098 in
Male / female connector exclusive pliers		SL-JPC	Snap female connector and snap male connector (SL-CP1 , CP2) can be connected in one grip.
SL-CP3 exclusive pliers		SL-JPE	4-pin type snap male connector (SL-CP3) can be connected in one grip.

FIBER SENSORS

LASER SENSORS

PHOTO-ELECTRIC SENSORS

MICRO PHOTO-ELECTRIC SENSORS

AREA SENSORS

LIGHT CURTAINS / SAFETY COMPONENTS

PRESSURE / FLOW SENSORS

INDUCTIVE PROXIMITY SENSORS

PARTICULAR USE SENSORS

SENSOR OPTIONS

SIMPLE WIRE-SAVING UNITS

WIRE-SAVING SYSTEMS

MEASUREMENT SENSORS

STATIC ELECTRICITY PREVENTION DEVICES

LASER MARKERS

PLC

HUMAN MACHINE INTERFACES

ENERGY CONSUMPTION VISUALIZATION COMPONENTS

FA COMPONENTS

MACHINE VISION SYSTEMS

UV CURING SYSTEMS

Upper Communication Unit

MIL Connector Plug-in

SC-GU3

SC-GU2-C

SC-GU1-485

ORDER GUIDE

Others

Designation	Model No.	Description	
Input connector	CN-EP1 5 pcs. per set	For 1 ch connector input unit (analog communication unit) SC-T1JA	Input connector is utilized to connect input devices to the 1-channel connector input unit (analog communication unit) SC-T1JA . SC-T1JA includes one CN-EP1 .
Index seals	SC-MA1 10 sheets per set	For 8 ch connector input unit SC-T8J and SC-TP8J	An identifier for each connector should be marked on each seal, then the seals should be applied to the numbering plates attached to the 8-channel connector input extension unit SC-T8J and 8-channel connector I/O mixed extension unit SC-TP8J . SC-T8J and SC-TP8J includes one SC-MA1 .
Connector end caps	SC-PK 8 pcs. per set		Utilized to protect the unconnected ends of connectors of 8-channel connector input extension unit SL-T8J and 8-channel connector I/O mixed extension unit SC-TP8J .

Input connector

- **CN-EP1**

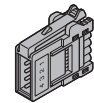

Index seals

- **SC-MA1**

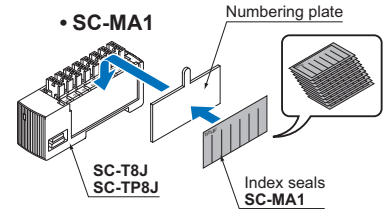

Connector end caps

- **SC-PK**

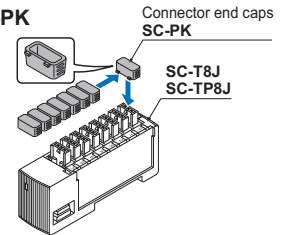

SPECIFICATIONS

Communication unit for CC-Link

Designation	Communication unit for CC-Link				
Item	Model No.	SC-GU2-C			
Applicable sensor amplifier (Note 2)	Sensor amplifiers (NPN output type) that can connect to non-line connector CN-70 (optional) (FX-500/300/311/410 series, LS-401/403, DPS-401/402, GA-311)				
Number of connectable units	Max. 16 units (sensor amplifiers / input units / I/O extension units) per SC-GU2-C (Maximum of 12 units including the FX-500 series can communicate optically)				
Supply voltage	24 V DC $\pm 1\%$ Ripple P-P 10 % or less				
Current consumption	110 mA or less (excluding connected sensor amplifiers / input units / I/O extension units)				
Allowable passing current	Wire-saving connector 2 A (Note 3), supply connector 6 A (Note 4)				
Communication method	CC-Link Ver.1.10				
Number of occupied station	Switchable 1 or 4 station				
Baud rate	10 Mbps	5 Mbps	2.5 Mbps	625 kbps	156 kbps
Total extension length	100 m 328.084 ft	150 m 492.126 ft	200 m 656.168 ft	600 m 1968.504 ft	1,200 m 3937.008 ft
Communication cable	Specified cable (twist pair cable with shield) (Note 5)				
Station No. setting	1 to 64 (0 and 65 or more: Error)				
Remote station type	Remote device station				
Ambient temperature	-10 to +55 °C +14 to +131 °F (If 4 to 7 units are connected in cascade: -10 to +50 °C +14 to +122 °F, if 8 to 16 units are connected in cascade: -10 to +45 °C +14 to +113 °F) (No dew condensation or icing allowed), Storage: -20 to +70 °C -4 to +158 °F				
Ambient humidity	35 to 85 % RH, Storage: 35 to 85 % RH				
Material	Enclosure: Heat-resistant ABS, Connector cap: Silicone rubber				
Weight	Net weight: 60 g approx., Gross weight: 100 g approx.				
Accessory	Connector cap: 2 pcs.				

- Notes: 1) Where measurement conditions have not been specified precisely, the conditions used were an ambient temperature of +23 °C +73.4 °F.
 2) Only the below models respond to data communication. **FX-501/502, FX-301/305, LS-403, DPS-401/402**
 3) Be sure to check that total current consumption of sensor amplifiers connected in cascade does not exceed allowable passing current.
 4) In case of supplying power to other devices, be sure to set the current less than allowable passing current.
 5) Use the CC-Link-specified cable.

1-channel connector input extension unit

Designation	1-channel connector input extension unit	
Item	Model No.	Analog communication unit
		SC-T1JA
Supply voltage	12 to 24 V DC $\pm 10\%$ Ripple P-P 10 % or less (By power supplied from the SC-GU2-C .)	
Current consumption (Note 2)	Max. 25 mA or less (when all indicators light up)	
Analog voltage input	Input voltage range: 1 to 5 V DC Input impedance: 200 kΩ approx.	
Communication data (Note 3)	Analog ↔ Communication data • Communication data: 0 to 4,000 digits (in the range of 1 to 5 V) • Zero point: Within 0 digit $\pm 0.5\%$ F.S. • Span: Within 4,000 digits $\pm 0.5\%$ F.S. • Linearity: Within $\pm 0.5\%$ F.S.	
Input	Connectable device: Output type of NPN open-collector transistor Supply current for input device: 100 mA or less Input impedance: 17 kΩ approx. Operating voltage: 17 V or more at ON voltage (between input and +V at 24 V) 4 V or less at OFF voltage (between input and +V at 24 V)	
Output	NPN open-collector transistor • Max. sink current: 50 mA • Applied voltage: 30 V DC or less • Residual voltage: 1.5 V or less (at 50 mA sink current)	
Power indicator	Green LED (lights up when the power is ON)	
Input indicator	Green LED (lights up when NPN input is ON)	
Ambient temperature	-10 to +55 °C +14 to +131 °F (If 4 to 7 units are connected in cascade: -10 to +50 °C +14 to +122 °F, if 8 to 16 units are connected in cascade: -10 to +45 °C +14 to +113 °F) (No dew condensation or icing allowed), Storage: -10 to +70 °C +14 to +158 °F	
Ambient humidity	35 to 85 % RH, Storage: 35 to 85 %	
Temperature characteristics	Within $\pm 1\%$ F.S. (at +25 °C +77 °F reference)	
Material	Enclosure: Heat-resistant ABS	
Weight	Net weight: 20 g approx., Gross weight: 40 g approx.	
Accessory	Connector (e-CON): 1 pc.	

- Notes: 1) Where measurement conditions have not been specified precisely, the conditions used were an ambient temperature of +23 °C +73.4 °F.
 2) The current consumption and input current of output device connected are not included.
 3) The relationship between communication data and input voltage is as described in the right figure.

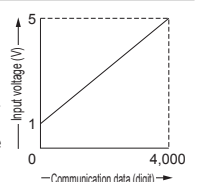

FIBER SENSORS
 LASER SENSORS
 PHOTO-ELECTRIC SENSORS
 MICRO PHOTO-ELECTRIC SENSORS
 AREA SENSORS
 LIGHT CURTAINS / SAFETY COMPONENTS
 PRESSURE / FLOW SENSORS
 INDUCTIVE PROXIMITY SENSORS
 PARTICULAR USE SENSORS
 SENSOR OPTIONS
 SIMPLE WIRE-SAVING UNITS
 WIRE-SAVING SYSTEMS
 MEASUREMENT SENSORS
 STATIC ELECTRICITY PREVENTION DEVICES
 LASER MARKERS
 PLC
 HUMAN MACHINE INTERFACES
 ENERGY CONSUMPTION VISUALIZATION COMPONENTS
 FA COMPONENTS
 MACHINE VISION SYSTEMS
 UV CURING SYSTEMS
 Upper Communication Unit
 MIL Connector Plug-in
SC-GU3
SC-GU2-C
SC-GU1-485

SPECIFICATIONS

End unit

Designation		End unit
Item	Model No.	SC-GU2-EU
Supply voltage	12 to 24 V DC $\pm 10\%$ Ripple P-P 10 % or less (By power supplied from the SC-GU2-C)	
Current consumption	10 mA or less	
Signal channel No.	(Not occupy the signal channel No.)	
Power indicator	Green LED (lights up when the power is ON)	
Cable	Type	0.38 mm ² single shielded cable [Heat resistant PVC (Black)]
	Sheath outer diameter	$\phi 1.46$ mm $\phi 0.057$ in
	Length	30 to 180 mm 1.181 to 7.087 in adjustable by cable length adjust button
	Tensile strength	Main body side: 20 N (Note 2)
Material	Enclosure: Heat-resistant ABS	
Weight	Net weight: 20 g approx., Gross weight: 40 g approx.	

Notes: 1) Where measurement conditions have not been specified precisely, the conditions used were an ambient temperature of +23 °C **+73.4 °F**.

2) For length adjustment of cable with communication connector, pull out the cable slowly. To remove the cable with communication connector from **SC-GU2-C**, hold the connector and remove it.

Connector input extension units / connector I/O extension units

Designation		1-channel connector input extension unit	8-channel connector input extension unit	8-channel connector I/O mixed extension unit
Item	Model No.	SC-T1J	SC-T8J	SC-TP8J
Supply voltage	12 to 24 V DC $\pm 10\%$ (By power supplied from the SC-GU2-C)			
Current consumption (Note 3)	20 mA or less (when all indicators light up)	60 mA or less (when all indicators light up)	7 mA or less	
Signal channel No.	1 input	8 inputs (Note 4)	8 inputs / outputs (Note 5)	
Connectable device	NPN open-collector, or DC 2-wire output type sensor, or switch etc.	NPN open-collector output sensor or switch etc. (Note 6)	commercially available I/O device including DC 2-wire type sensor	
Supply current for units (Note 7)	100 mA or less	800 mA or less (At a total of 8 channels)		
Power indicator	Green LED (Lights up when the power is ON)			
Input indicator	Green LED [SC-T1J : 1 No., SC-T8J : 8 Nos.] (Lights up when each channel input is ON)			
Ambient temperature	-10 to +45 °C +14 to +113 °F (No dew condensation or icing allowed), Storage: -20 to +70 °C -4 to +158 °F			
Ambient humidity	35 to 85 % RH, Storage: 35 to 85 % RH			
Material	Enclosure: Heat-resistant ABS			
Net weight	10 g approx.	40 g approx.		
Accessories	SL-CP1 (Snap male connector): 1 pc.		Index seal : 1 pc.	

Notes: 1) Where measurement conditions have not been specified precisely, the conditions used were an ambient temperature of +20 °C **+68 °F**.

2) It depends on the power supply from **SC-MIL**.

3) The current consumption and input current of the input unit connected are not included.

4) The signal for 8 channels is occupied regardless of number of input units connected.

5) The signal for 8 channels is occupied regardless of number of I/O units connected.

6) DC 2-wire type sensor and switch etc. cannot be connected (**SC-T8J** only).

7) Set the maximum current passing through input / output line to 50 mA or less.

Plug-in Sensor units (MIL connectors)

Type		Separate unit	Main unit
Item	Model No.	SC-MIL-S	SC-MIL
Supply voltage	By power supplied from the SC-GU2-C		12 to 24 V DC $\pm 10\%$ (Note 2) By power supplied from the SC-GU2-C
Allowable through current (Note 3)	1 A or less (Same as maximum permissible current consumption of all units connected to SC-MIL-S .)	2 A or less (Same as maximum permissible current consumption of all units connected to SC-MIL .)	
Signal channel No.	Connectable up to 16 channels (The signal from up to 16th point (counting from unit adjacent to SC-MIL) of all units connected to SC-MIL is transferred.) However, the signal thereafter is not transferred. Note that SC-MIL and SC-MIL-S do not occupy any signal point.		
Max. distance between units	10 m 32.808 ft or less (the distance between SC-MIL and PLC and that between SC-MIL and SC-MIL-S put together)		
Ambient temperature	-10 to +45 °C +14 to +113 °F (No dew condensation or icing allowed), Storage: -20 to +70 °C -4 to +158 °F		
Ambient humidity	35 to 85 % RH, Storage: 35 to 85 % RH		
Material	Enclosure: Heat-resistant ABS		
Weight	Net weight: 20 g approx.	Net weight: 25 g approx.	
Accessory	Connector protection seal: 1 pc.		

Notes: 1) Where measurement conditions have not been specified precisely, the conditions used were an ambient temperature of +20 °C **+68 °F**.

2) The plug-in sensor main unit **SC-MIL** incorporates a cable lead-out connector in addition to the MIL connector, which allows to receive the supply voltage from the separate power supply.

3) When either the power supply device's allowable amount of current or the connecting cable's allowable amount of current is smaller than the allowable current passage value, match it with the smallest specification.

PRECAUTIONS FOR PROPER USE

Refer to p.1501 for general precautions.

FIBER SENSORS

LASER SENSORS

PHOTO-ELECTRIC SENSORS

MICRO PHOTO-ELECTRIC SENSORS

AREA SENSORS

LIGHT CURTAINS / SAFETY COMPONENTS

PRESSURE / FLOW SENSORS

INDUCTIVE PROXIMITY SENSORS

PARTICULAR USE SENSORS

SENSOR OPTIONS

SIMPLE WIRE-SAVING UNITS

WIRE-SAVING SYSTEMS

MEASUREMENT SENSORS

STATIC ELECTRICITY PREVENTION DEVICES

LASER MARKERS

PLC

HUMAN MACHINE INTERFACES

ENERGY CONSUMPTION VISUALIZATION COMPONENTS

FA COMPONENTS

MACHINE VISION SYSTEMS

UV CURING SYSTEMS

Upper Communication Unit
MIL Connector Plug-in

SC-GU3

SC-GU2-C

SC-GU1-485



- Never use this product in a device for personnel protection.
- In case of using sensing devices for personnel protection, use products which meet laws and standards, such as OSHA, ANSI or IEC etc., for personnel protection applicable in each region or country.

DIMENSIONS (Unit: mm in)

The CAD data in the dimensions can be downloaded from our website

SC-GU2-C Communication unit for CC-Link

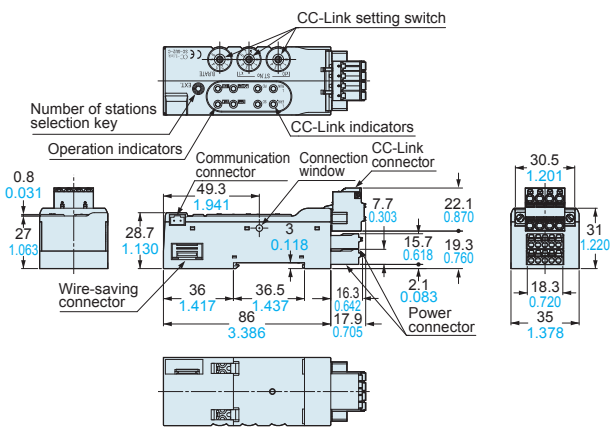

SC-GU2-EU End unit

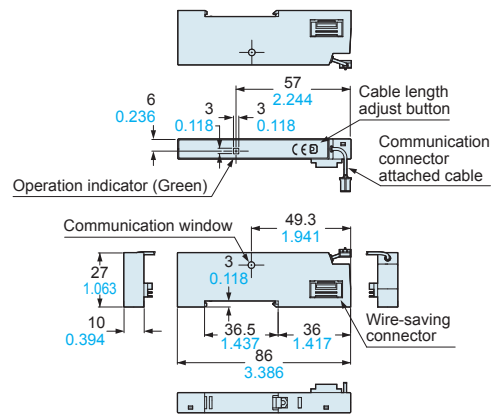

SC-T1JA 1-channel connector input extension unit

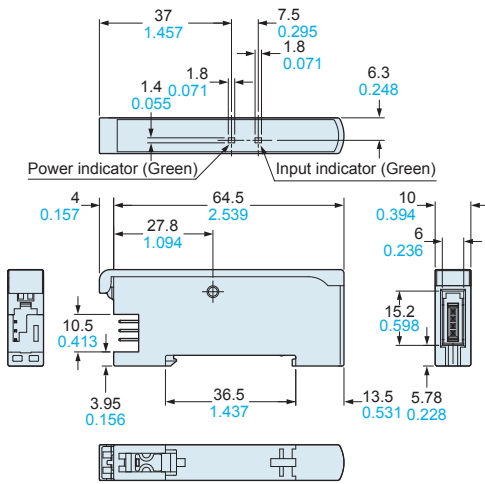

CN-70 Non-line connector (Optional)

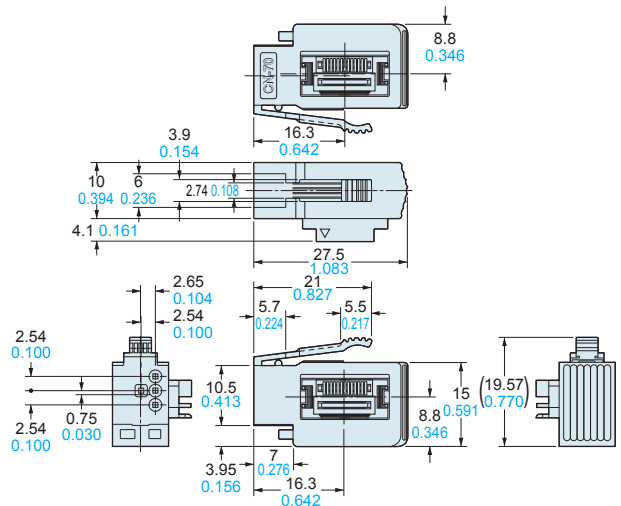

MS-DIN-E End plates (Optional)

