

PRECISION 2.5 VOLT MICROPOWER VOLTAGE REFERENCE

ZR4040-2.5

ISSUE 3 - MARCH 1998

DEVICE DESCRIPTION

The ZR4040-2.5 uses a bandgap circuit design to achieve a precision micropower voltage reference of 2.5 volts. The device is available in small outline surface mount packages, ideal for applications where space saving is important, as well as packages for through hole requirements.

The ZR4040-2.5 design provides a stable voltage without an external capacitor and is stable with capacitive loads. The ZR4040-2.5 is recommended for operation between $60\mu\text{A}$ and 15mA and so is ideally suited to low power and battery powered applications.

Excellent performance is maintained to an absolute maximum of 25mA , however the rugged design and 20 volt processing allows the reference to withstand transient effects and currents up to 200mA . Superior switching capability allows the device to reach stable operating conditions in only a few microseconds.

FEATURES

- Small outline SO8 and SOT23 packages
- TO92 style package
- No stabilising capacitor required
- Typical T_C $30\text{ppm}/^\circ\text{C}$
- Typical slope resistance 0.4Ω
- 2% 1% and 0.5 % tolerance
- Industrial temperature range
- Operating current $60\mu\text{A}$ to 15mA
- Transient response, stable in less than $10\mu\text{s}$

APPLICATIONS

- Battery powered and portable equipment.
- Metering and measurement systems.
- Instrumentation.
- Test equipment.
- Data acquisition systems.
- Precision power supplies.

SCHEMATIC DIAGRAM

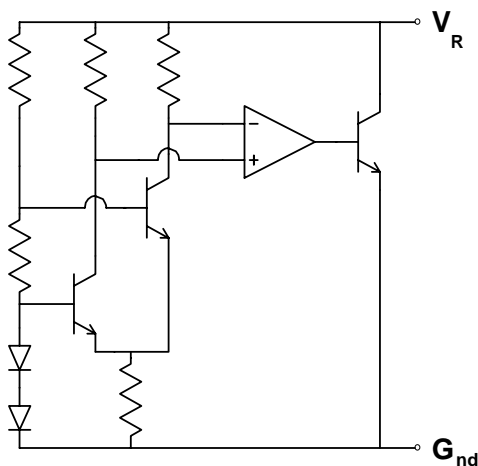

ZR4040-2.5

ABSOLUTE MAXIMUM RATING

Reverse Current	25mA
Forward Current	25mA
Operating Temperature	-40 to 85°C
Storage Temperature	-55 to 125°C

Power Dissipation (T_{amb}=25°C)

SOT23	330mW
SO8	625mW
E-Line, 3 pin (TO92)	500mW

ELECTRICAL CHARACTERISTICS

TEST CONDITIONS (Unless otherwise stated) T_{amb}=25°C

SYMBOL	PARAMETER	CONDITIONS	LIMITS			TOL. %	UNITS
			MIN	TYP	MAX		
V _R	Reverse Breakdown Voltage	I _R =150μA	2.4875 2.475 2.45	2.5 2.5 2.5	2.5125 2.525 2.55	0.5 1 2	V
I _{MIN}	Minimum Operating Current			25	60		μA
I _R	Recommended Operating Current		0.06		15		mA
T _C †	Average Reverse Breakdown Voltage Temp. Co.	I _{R(min)} to I _{R(max)}		30	100		ppm/°C
R _S §	Slope Resistance			0.4	2		Ω
Z _R	Reverse Dynamic Impedance	I _R = 1mA f = 100Hz I _{AC} =0.1 I _R		0.3	0.8		Ω
E _N	Wideband Noise Voltage	I _R = 1mA f = 10Hz to 10kHz		45			μV (rms)

$$\dagger T_C = \frac{(V_{R(max)} - V_{R(min)}) \times 1000000}{V_R \times (T_{(max)} - T_{(min)})}$$

Note: V_{R(max)} - V_{R(min)} is the maximum deviation in reference voltage measured over the full operating temperature range.

$$\S R_S = \frac{V_R \text{ Change}(I_R(\min) \text{ to } I_R(\max))}{I_R(\max) - I_R(\min)}$$

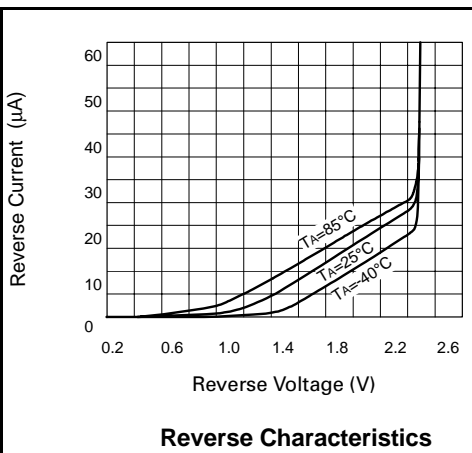

ZR4040-2.5

TYPICAL CHARACTERISTICS

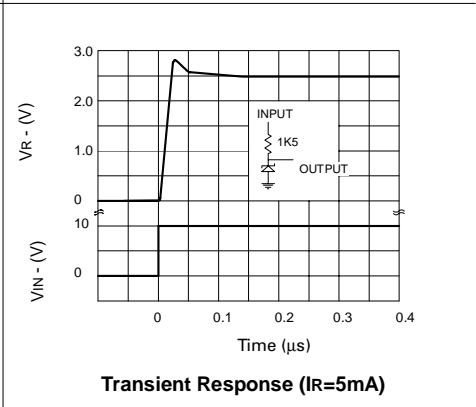
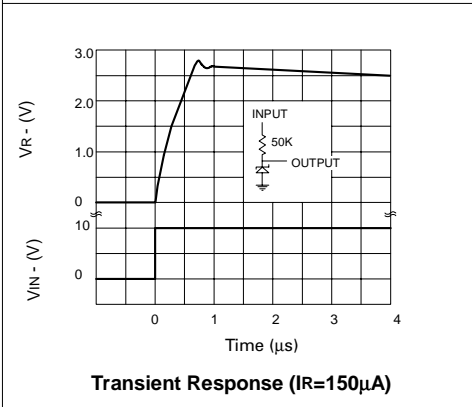
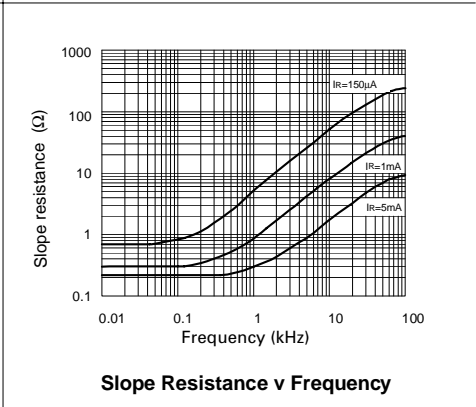
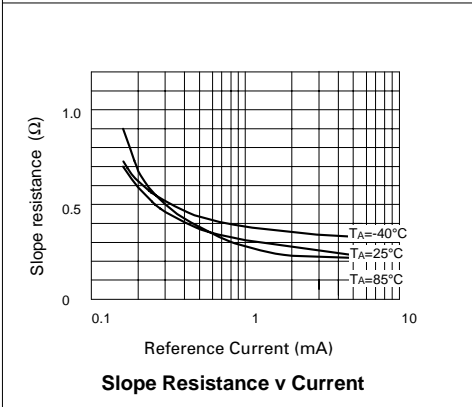
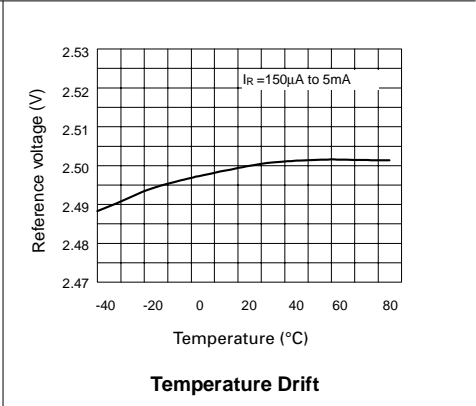
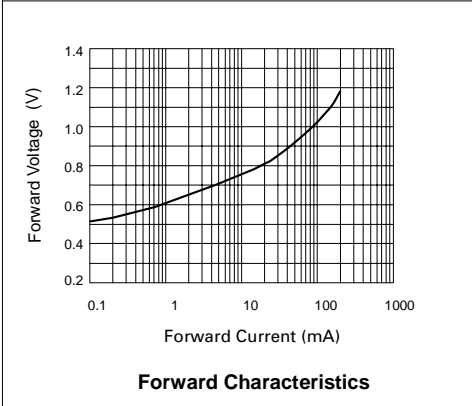

ZR4040-2.5

CONNECTION DIAGRAMS

SO8 Package Suffix – N8

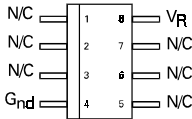

Top View

SOT23 Package Suffix – F

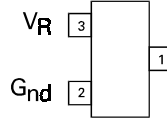

Top View –
Pin 1 floating or connected to pin 2

E-Line, 3 pin, Rev Package Suffix – R

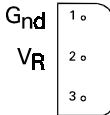

Bottom View –
Pin 3 floating or connected to pin 1

ORDERING INFORMATION

Part Number	Tol%	Package	Partmark
ZR40402F25	2	SOT23	25L
ZR40401F25	1	SOT23	25M
ZR404005F25	0.5	SOT23	25V
ZR40402N825	2	SO8	ZR4040225
ZR40401N825	1	SO8	ZR4040125
ZR404005N825	0.5	SO8	ZR4040525
ZR40402R25	2	E-Line *	ZR4040225
ZR40401R25	1	E-Line *	ZR4040125
ZR404005R25	0.5	E-Line *	ZR4040525

* E-Line, 3 pin Reversed