

## Connectors according to DIN 41612 / IEC 60603-2

### Type R

Female connector

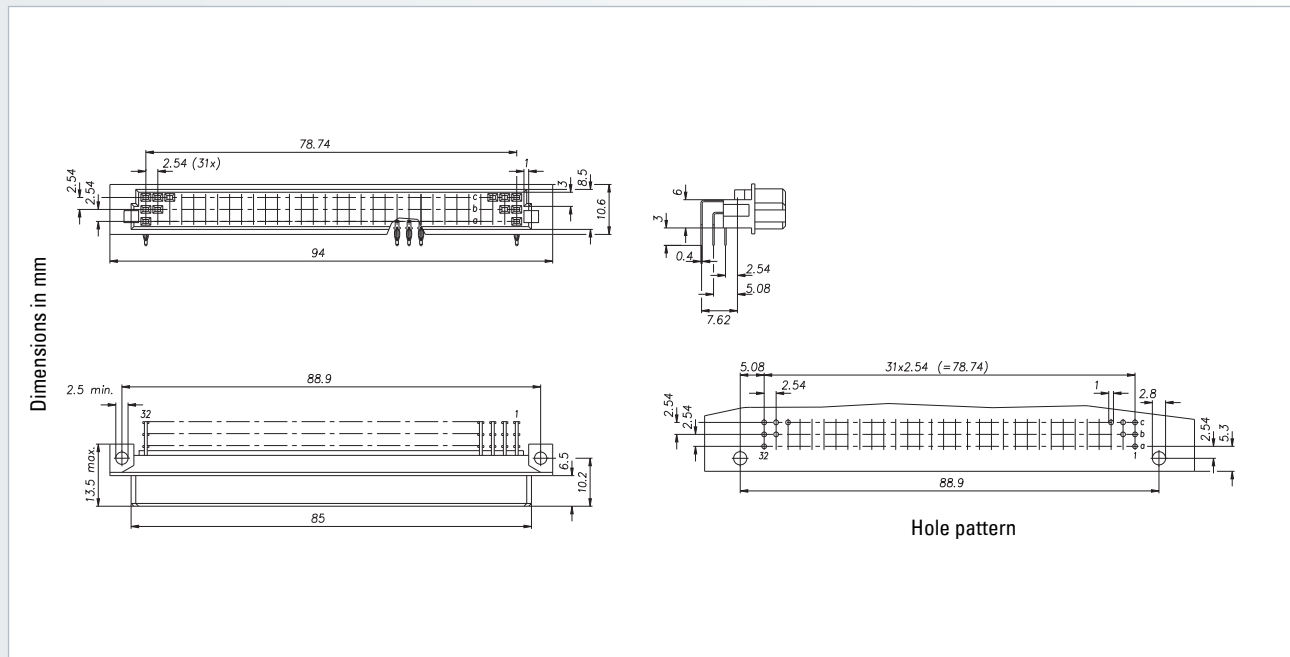

| No. of contacts | Contact arrangement | Press-fit technology – Performance level II |
|-----------------|---------------------|---|
|                 |                     | Termination length                          |
|                 |                     | Part number                                 |
| 64              |                     | 116-60054                                   |
| 96              |                     | 116-60074                                   |

|   |   |   |
|---|---|---|
| <b>Accessories</b> <ul style="list-style-type: none"> <li>– Press-fit tool (see page 210)</li> <li>– Support tool (see page 211)</li> </ul> | <b>On request</b> <ul style="list-style-type: none"> <li>– Performance levels I + III or customer-specific</li> <li>– Special contact length</li> </ul> | <b>Options</b> <ul style="list-style-type: none"> <li>– Without flange</li> <li>– Contact arrangement (see page 162)</li> </ul> |
|---|---|---|

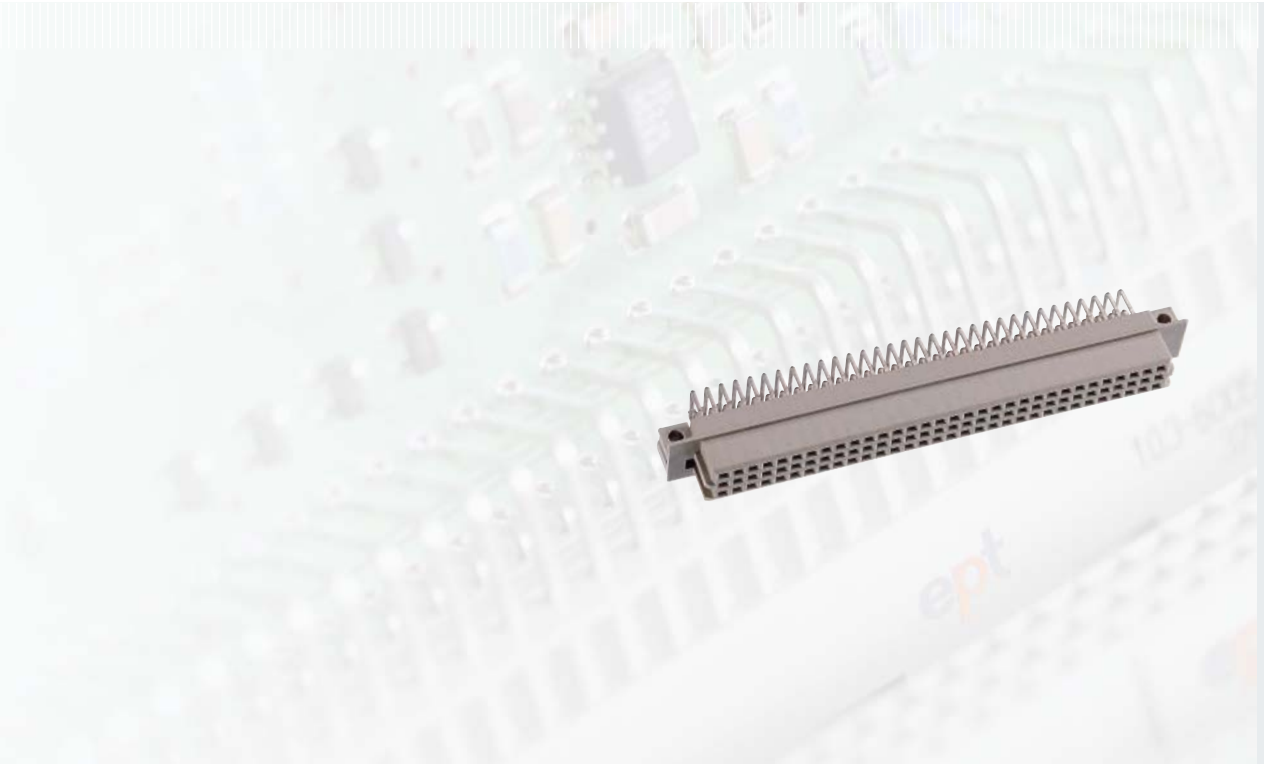

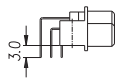
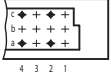
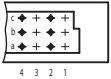
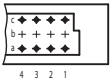
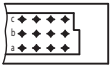
| No. of contacts | Contact arrangement   | Solder technology – Performance level II  |  |
|-----------------|---|---|--|
|                 |   | Termination length  |  |
|                 |   |  |  |
|                 |   | Part number   |  |
| 32              |  | 116-40034   |  |
| 48              |  | 116-40044   |  |
| 64              |  | 116-40054   |  |
| 96              |  | 116-40074   |  |

**On request**

- Performance levels I + III or customer-specific
- Special contact length
- Also in THTR

**Options**

- Board lock (see page 159)
- Contact arrangement (see page 162)