

KEMET Part Number: Z0805C250APWST
(Z0805C250APWST)

KEMET
a YAGEO company

KEMET, Z-PWS, Ferrite Beads, Noise Suppression, 4 mOhms

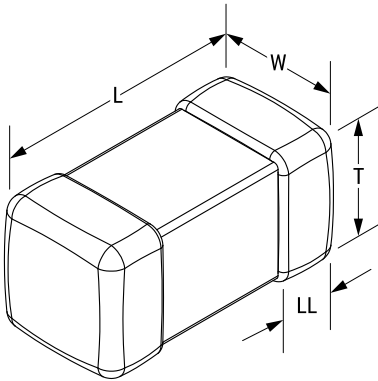

Dimensions

Chip Size	0805
L	2mm +/-0.2mm
W	1.25mm +/-0.2mm
T	0.85mm +/-0.2mm
B	0.5mm +/-0.3mm

Packaging Specifications

Packaging:	T&R
Packaging Quantity:	4000

General Information

Series:	Z-PWS
Style:	SMD Chip
Description:	Chip Bead, Power Line
Features:	Broadband
RoHS:	Yes

Specifications

Impedance:	25 Ohms (100 mHz)
Impedance Tolerance:	30%
Ripple Current:	6000 mA (MAX)
Temperature Range:	-40/+125°C
Resistance:	0.004 Ohms

Statements of suitability for certain applications are based on our knowledge of typical operating conditions for such applications, but are not intended to constitute - and we specifically disclaim - any warranty concerning suitability for a specific customer application or use. This Information is intended for use only by customers who have the requisite experience and capability to determine the correct products for their application. Any technical advice inferred from this Information or otherwise provided by us with reference to the use of our products is given gratis, and we assume no obligation or liability for the advice given or results obtained.

KEMET
a YAGEO company