

Performance Specification

Model	Marking	Maximum							Resistance	
		V _{max}	I _{max}	I _{hold}	I _{trip}	P _d	Time To Trip		R _{i min}	R _{1max}
				@25°C	@25°C	Typ.	Current	Time	(Ω)	(Ω)
		(V dc)	(A)	(A)	(A)	(W)	(A)	(Sec)		
JSMD1812-010	JS/010	30.0	100	0.10	0.30	0.8	0.5	1.50	0.750	15.000
JSMD1812-010/60	JS/010	60.0	100	0.10	0.30	0.8	0.5	1.50	0.750	15.000
JSMD1812-014	JS/014	60.0	100	0.14	0.34	0.8	1.5	0.15	0.650	6.000
JSMD1812-020	JS/020	30.0	100	0.20	0.40	0.8	8.0	0.02	0.350	5.000
JSMD1812-020/60	JS/02	60.0	100	0.20	0.40	0.8	8.0	0.02	0.350	5.000
JSMD1812-030	JS/030	30.0	100	0.30	0.60	0.8	8.0	0.10	0.250	3.000
JSMD1812-035	JS/035	30.0	100	0.30	0.60	0.8	8.0	0.10	0.250	3.000
JSMD1812-035/60	JS/03	60.0	100	0.30	0.60	0.8	8.0	0.10	0.250	3.000
JSMD1812-050	JS/050	16.0	100	0.50	1.00	0.8	8.0	0.15	0.150	1.000
JSMD1812-050/30	JS/050	30.0	100	0.50	1.00	0.8	8.0	0.15	0.150	1.000
JSMD1812-050/60	JS/05	60.0	100	0.50	1.00	0.8	8.0	0.15	0.150	1.000
JSMD1812-075	JS/075	16.0	100	0.75	1.50	0.8	8.0	0.20	0.090	0.450
JSMD1812-075/24	JS/075	24.0	100	0.75	1.50	0.8	8.0	0.20	0.090	0.450
JSMD1812-075/33	JS/07	33.0	100	0.75	1.50	0.8	8.0	0.20	0.090	0.450
JSMD1812-110	JS/110	8.0	100	1.10	2.20	0.8	8.0	0.30	0.050	0.250
JSMD1812-110/12	JS/110	12.0	100	1.10	2.20	0.8	8.0	0.30	0.050	0.250
JSMD1812-110/16	JS/110	16.0	100	1.10	2.20	0.8	8.0	0.30	0.050	0.250
JSMD1812-110/24	JS/11	24.0	100	1.10	2.20	0.8	8.0	0.30	0.050	0.250
JSMD1812-110/33	JS11/3 3	33.0	100	1.10	2.20	0.8	8.0	0.30	0.050	0.250
JSMD1812-125	JS/125	8.0	100	1.25	2.50	0.8	8.0	0.40	0.050	0.140
JSMD1812-125/12	JS/125	12.0	100	1.25	2.50	0.8	8.0	0.40	0.050	0.140
JSMD1812-125/16	JS/12	16.0	100	1.25	2.50	0.8	8.0	0.40	0.050	0.140
JSMD1812-150	JS/150	8.0	100	1.50	3.00	0.8	8.0	0.50	0.040	0.160
JSMD1812-150/12	JS/150	12.0	100	1.50	3.00	0.8	8.0	0.50	0.040	0.160
JSMD1812-150/16	JS/15	16.0	100	1.50	3.00	0.8	8.0	0.50	0.040	0.160
JSMD1812-150/24	JS/150	24.0	100	1.50	3.00	0.8	8.0	0.50	0.040	0.160
JSMD1812-160	JS/160	8.0	100	1.60	2.80	0.8	8.0	1.00	0.030	0.130
JSMD1812-160/12	JS/160	12.0	100	1.60	2.80	0.8	8.0	1.00	0.030	0.130
JSMD1812-160/16	JS/16	16.0	100	1.60	2.80	0.8	8.0	1.00	0.030	0.130
JSMD1812-200	JS/200	8.0	100	2.00	4.00	0.8	8.0	2.00	0.020	0.100
JSMD1812-200/12	JS/20	12.0	100	2.00	4.00	0.8	8.0	2.00	0.020	0.100
JSMD1812-200/16	JS/20	16.0	100	2.00	4.00	0.8	8.0	2.00	0.020	0.100

JSMD1812-250	JS/250	8.0	100	2.50	5.00	0.8	8.0	5.00	0.015	0.075
JSMD1812-250/12	JS/25	12.0	100	2.50	5.00	0.8	8.0	5.00	0.015	0.075
JSMD1812-250/16	JS25/16	16.0	100	2.50	5.00	0.8	8.0	5.00	0.015	0.075
JSMD1812-260	JS/260	8.0	100	2.60	5.00	0.8	8.0	2.50	0.015	0.050
JSMD1812-260/12	JS/260	12.0	100	2.60	5.00	0.8	8.0	2.50	0.015	0.050
JSMD1812-260/16	JS26/16	16.0	100	2.60	5.00	0.8	8.0	2.50	0.015	0.050
JSMD1812-300	JS/300	12.0	100	3.00	5.00	0.8	8.0	4.00	0.012	0.040
JSMD1812-300/8	JS/300	12.0	100	3.00	5.00	0.8	8.0	4.00	0.012	0.040

V max = Maximum operating voltage device can withstand without damage at rated current (I_{max}).

I max = Maximum fault current device can withstand without damage at rated voltage (V_{max}).

I hold = Hold Current. Maximum current device will not trip in 25°C still air.

I trip = Trip Current. Minimum current at which the device will always trip in 25°C still air.

Pd = Power dissipation when device is in the tripped state in 25°C still air environment at rated voltage.

Ri min/max = Minimum/Maximum device resistance prior to tripping at 25°C.



R1max = Maximum device resistance is measured one hour post reflow.

CAUTION : Operation beyond the specified ratings may result in damage and possible arcing and flame.

Environmental Specifications

Test	Conditions	Resistance change
Passive aging	+85°C, 1000 hrs.	±5% typical
Humidity aging	+85°C, 85% R.H. , 168 hours	±5% typical
Thermal shock	+85°C to -40°C, 20 times	±33% typical
Resistance to solvent	MIL-STD-202, Method 215	No change
Vibration	MIL-STD-202, Method 201	No change
Ambient operating conditions : - 40 °C to +85 °C		
Maximum surface temperature of the device in the tripped state is 125 °C		

Agency Approval and Environmental Compliance

Agency	File Number	Regulation	Standard
UL	EN217453		2002/95/EC
TUV	pending		EN14582

Thermal Derating Chart

Recommended Hold Current(A) at Ambient Temperature(°C)

Model	Ambient Operation Temperature								
	-40°C	-20°C	0°C	25°C	40°C	50°C	60°C	70°C	85°C
JSMD1812-010	0.16	0.14	0.12	0.10	0.08	0.07	0.06	0.05	0.03
JSMD1812-014	0.23	0.19	0.17	0.14	0.12	0.10	0.09	0.08	0.06
JSMD1812-020	0.29	0.26	0.23	0.20	0.17	0.15	0.14	0.12	0.10
JSMD1812-030	0.44	0.39	0.35	0.30	0.26	0.23	0.21	0.18	0.15
JSMD1812-035	0.50	0.45	0.40	0.35	0.30	0.26	0.24	0.20	0.16
JSMD1812-050	0.59	0.57	0.55	0.50	0.45	0.43	0.35	0.30	0.23
JSMD1812-075	1.10	0.99	0.87	0.75	0.63	0.57	0.49	0.45	0.35
JSMD1812-110	1.60	1.45	1.28	1.10	0.92	0.83	0.71	0.66	0.52
JSMD1812-125	2.00	1.75	1.52	1.25	1.00	0.95	0.90	0.75	0.53
JSMD1812-150	2.30	2.05	1.77	1.50	1.23	1.09	0.95	0.82	0.61
JSMD1812-160	2.10	1.96	1.88	1.60	1.26	1.12	0.98	0.84	0.63
JSMD1812-200	2.88	2.61	2.25	2.00	1.80	1.66	1.45	1.09	0.80
JSMD1812-250	3.27	3.04	2.88	2.50	2.21	2.07	1.92	1.78	1.57
JSMD1812-260	3.90	3.42	2.96	2.60	2.33	2.07	1.94	1.35	1.00
JSMD1812-300	4.15	3.76	3.46	3.00	2.55	2.28	2.01	1.61	1.33

Thermal Derating Curve

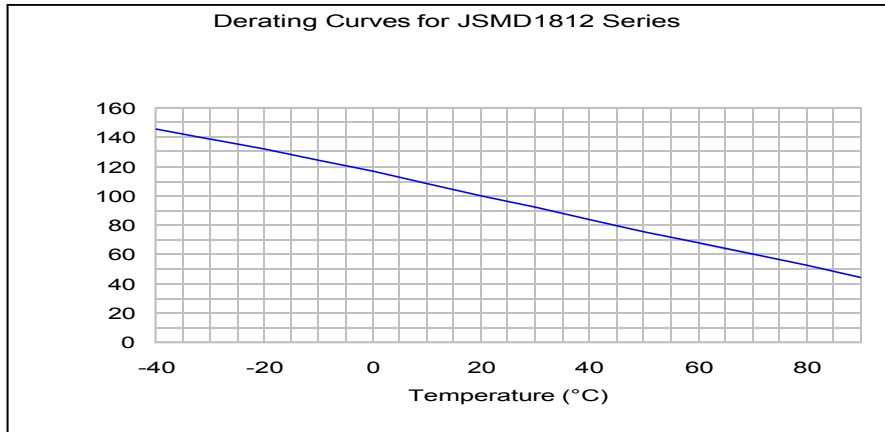

Average Time-Current Curve

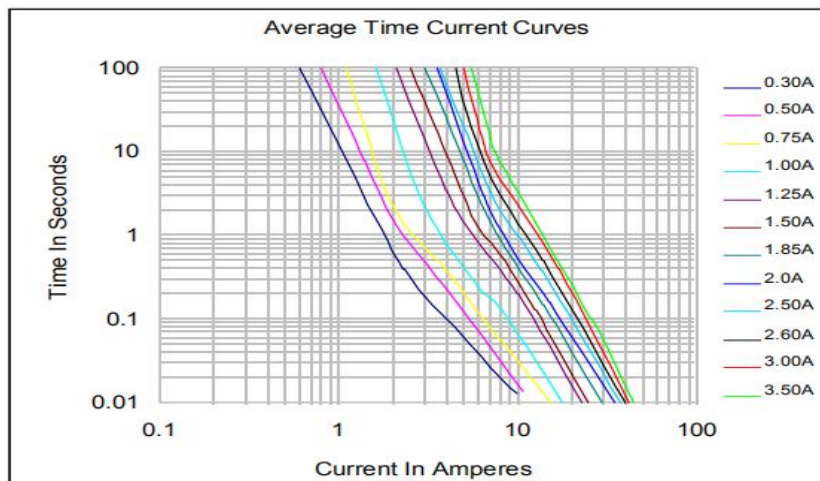

Soldering Parameters

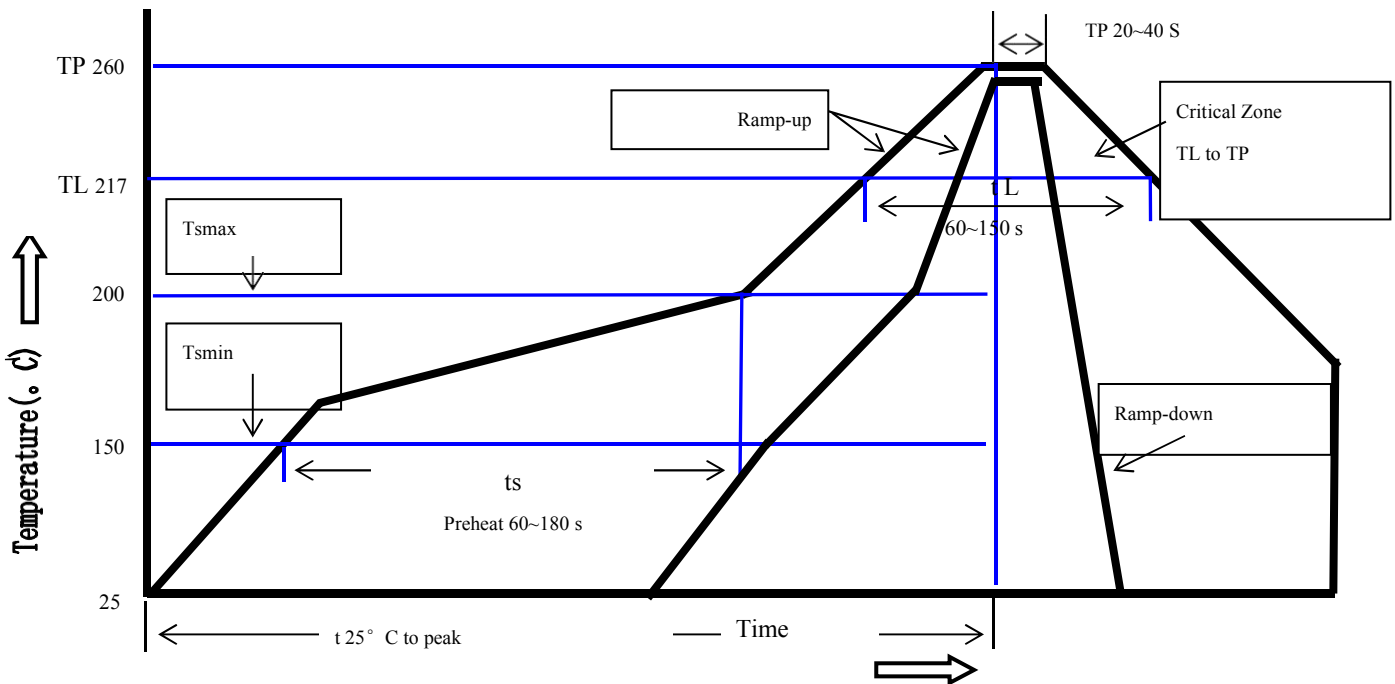

Profile Feature	Pb-Free Assembly
Average Ramp-Up Rate(Ts max to T p)	3°C/second max.
Preheat	
-Temperature Min(Ts min)	150°C
-Temperature Max(Ts max)	200°C
-Time(Ts min to Ts max)	60~180 seconds
Time maintained above:	
-Temperature(TL)	217°C
-Time(tL)	60~150 seconds
Peak Temperature(Tp)	260°C
Ramp-Down Rate	6°C/second max.
Time 25°C to Peak Temperature	8 minutes max
Storage Condition	0°C~35°C, ≤70%RH

Recommended reflow methods: IR, vapor phase oven, hot air oven, N2 environment for lead-free

Recommended maximum paste thickness is 0.25mm

Devices can be cleaned using standard industry methods and solvents.

Note 1: All temperature refer to topside of the package, measured on the package body surface.

Note 2: If reflow temperatures exceed the recommended profile, devices may not meet the performance requirements.

Physical Dimensions(mm.)

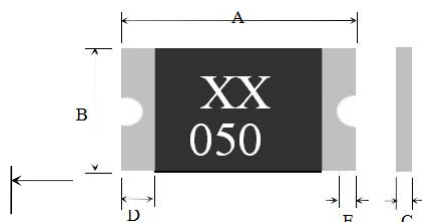

Model	A		B		C		D	E
	Min.	Max.	Min.	Max.	Min.	Max.	Min.	Min.
JSMD1812-010	4.37	4.73	3.07	3.41	0.50	1.00	0.30	0.25
JSMD1812-010/60	4.37	4.73	3.07	3.41	0.50	1.00	0.30	0.25
JSMD1812-014	4.37	4.73	3.07	3.41	0.50	1.30	0.30	0.25
JSMD1812-020	4.37	4.73	3.07	3.41	0.50	1.30	0.30	0.25
JSMD1812-020/60	4.37	4.73	3.07	3.41	0.50	1.00	0.30	0.25
JSMD1812-030	4.37	4.73	3.07	3.41	0.50	1.30	0.30	0.25
JSMD1812-035	4.37	4.73	3.07	3.41	0.65	1.15	0.30	0.25
JSMD1812-035/60	4.37	4.73	3.07	3.41	1.00	1.50	0.30	0.25
JSMD1812-050	4.37	4.73	3.07	3.41	0.40	0.90	0.30	0.25
JSMD1812-050/30	4.37	4.73	3.07	3.41	0.40	0.90	0.30	0.25
JSMD1812-050/60	4.37	4.73	3.07	3.41	1.10	1.80	0.30	0.25
JSMD1812-075	4.37	4.73	3.07	3.41	0.40	0.90	0.30	0.25
JSMD1812-075/24	4.37	4.73	3.07	3.41	0.60	1.30	0.30	0.25
JSMD1812-075/33	4.37	4.73	3.07	3.41	0.60	1.30	0.30	0.25
JSMD1812-110	4.37	4.73	3.07	3.41	0.40	0.90	0.30	0.25
JSMD1812-110/12	4.37	4.73	3.07	3.41	0.40	0.90	0.30	0.25
JSMD1812-110/16	4.37	4.73	3.07	3.41	0.60	1.30	0.30	0.25
JSMD1812-110/24	4.37	4.73	3.07	3.41	0.60	1.30	0.30	0.25
JSMD1812-110/33	4.37	4.73	3.07	3.41	1.10	1.80	0.30	0.25
JSMD1812-125	4.37	4.73	3.07	3.41	0.60	1.30	0.30	0.25
JSMD1812-125/12	4.37	4.73	3.07	3.41	0.60	1.30	0.30	0.25
JSMD1812-125/16	4.37	4.73	3.07	3.41	0.65	1.15	0.30	0.25
JSMD1812-150	4.37	4.73	3.07	3.41	0.40	0.90	0.30	0.25
JSMD1812-150/12	4.37	4.73	3.07	3.41	0.35	0.85	0.30	0.25
JSMD1812-150/16	4.37	4.73	3.07	3.41	0.60	1.30	0.30	0.25
JSMD1812-150/24	4.37	4.73	3.07	3.41	0.40	1.20	0.30	0.25
JSMD1812-160	4.37	4.73	3.07	3.41	0.40	0.90	0.30	0.25
JSMD1812-160/12	4.37	4.73	3.07	3.41	0.35	0.85	0.30	0.25
JSMD1812-160/16	4.37	4.73	3.07	3.41	1.10	1.80	0.30	0.25
JSMD1812-200	4.37	4.73	3.07	3.41	0.60	1.30	0.30	0.25
JSMD1812-200/12	4.37	4.73	3.07	3.41	0.65	1.15	0.30	0.25
JSMD1812-200/16	4.37	4.73	3.07	3.41	1.10	1.80	0.30	0.25
JSMD1812-250	4.37	4.73	3.07	3.41	0.35	0.85	0.30	0.25
JSMD1812-250/12	4.37	4.73	3.07	3.41	0.65	1.15	0.30	0.25
JSMD1812-250/16	4.37	4.73	3.07	3.41	1.00	1.50	0.30	0.25
JSMD1812-260	4.37	4.73	3.07	3.41	0.50	1.30	0.30	0.25
JSMD1812-260/12	4.37	4.73	3.07	3.41	0.65	1.15	0.30	0.25
JSMD1812-260/16	4.37	4.73	3.07	3.41	1.00	1.50	0.30	0.25
JSMD1812-300	4.37	4.73	3.07	3.41	0.50	1.30	0.30	0.25
JSMD1812-300/8	4.37	4.73	3.07	3.41	1.00	1.50	0.30	0.25

Termination Pad Characteristics

Terminal pad materials: Tin-plated Nickel-Copper

Terminal pad solder ability: Meets EIA specification RS186-9E and ANSI/J-STD-002 Category 3.

Recommended Pad Layout (mm.)

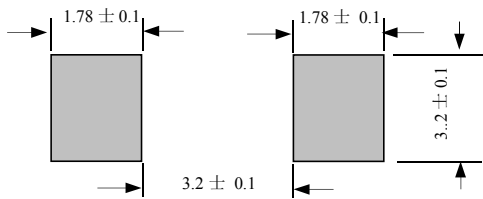

Packaging Quantity

Part Number	Quantity
JSMD 035/60.050/60.110/33.150/24.250/16.260/16.300.300/8	1,000 pcs/reel
JSMD 010.010/60.014.020.020/60.030.035.075/33.110/24.125.1 6.150.16.160/16.200/12.200/16.250/12.260/12	1,500 pcs/reel
The others	2,000 pcs/reel

Tape & reel packaging per EIA481-1

Tape And Reel Specifications (mm)

Governing Specifications	EIA 481-1
W	12 ± 0.3
P0	4.0 ± 0.10
P1	8.0 ± 0.10
P2	2.0 ± 0.05
A0	3.5 ± 0.10
B0	5.1 ± 0.10
B1max.	5.9
D0	1.50 + 0.1, -0
F	5.5 ± 0.05
E1	1.75 ± 0.10
E2min.	10.25
T	0.6
T1max.	0.1
K0	0.9 ± 0.1
Leader min.	390
Trailer min.	160
Reel Dimensions	
A max.	178
N min.	60
W1	12.4 ± 0.5
W2	18.4

EIA Tape Component Dimensions

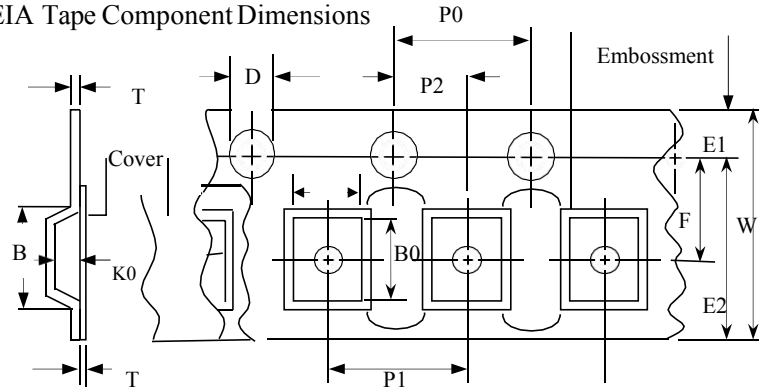

EIA Reel Dimensions

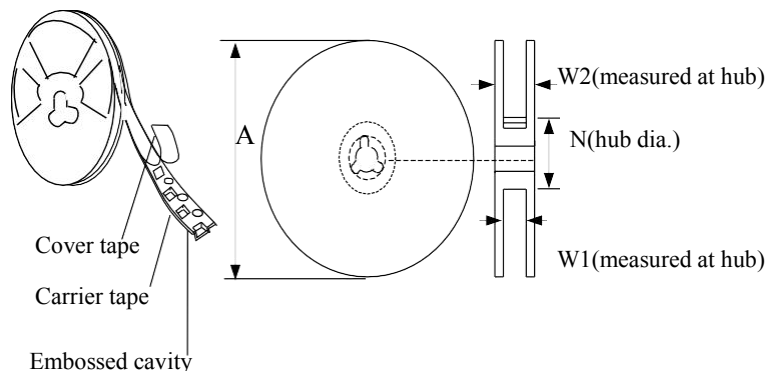

Storage And Handling

- Storage conditions: 35°C max, 70% R.H.
- Devices may not meet specified performance if storage conditions are exceeded.

Part Number System

J SMD1812-□□□□ / □□

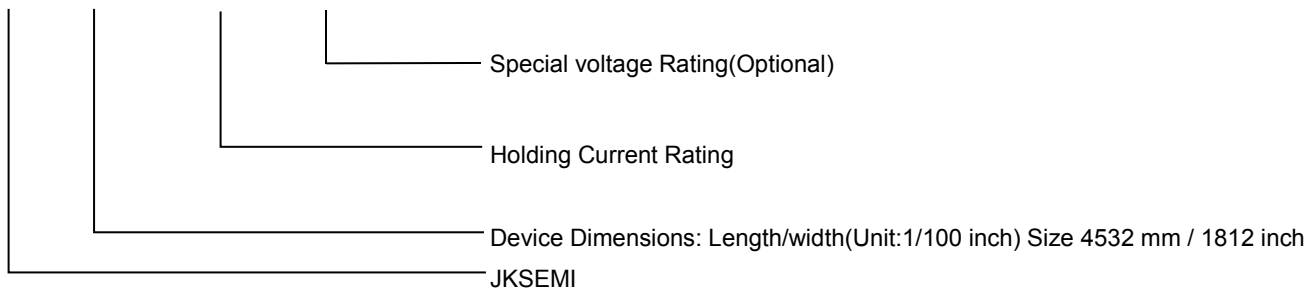

Cross Reference

JKSEMI	Cross Reference				
	TYCO/Raychem	Littelfuse	Bourns / Multifuse®	Polytronics / EVERFUSE®	SEA-LAND
JSMD1812-010	miniSMDC010F	1812L010	MF-MSMF010	SMD1812P010TF	mSMD010
JSMD1812-010/60	-	1812L010/60	-	SMD1812P010TF/60	mSMD010-60V
JSMD1812-014	miniSMDC014F	1812L014	MF-MSMF014	SMD1812P014TF	mSMD014
JSMD1812-020	miniSMDC020F	1812L020	MF-MSMF020	SMD1812P020TF	mSMD020
JSMD1812-020/60	-	1812L020/60	MF-MSMF020/60	-	mSMD020-60V
JSMD1812-030	miniSMDC030F	-	MF-MSMF030	-	mSMD030
JSMD1812-035	-	-	-	-	-
JSMD1812-035/60	-	-	-	SMD1812P035TF/60	-
JSMD1812-050	miniSMDC050F	1812L050	MF-MSMF050	SMD1812P050TF	mSMD050
JSMD1812-050/30	-	1812L050/30	MF-MSMF050/30X	SMD1812P050TF/30	-
JSMD1812-050/60	-	1812L050/60	-	SMD1812P050TF/60	mSMD050-60V
JSMD1812-075	miniSMDC075F	1812L075	MF-MSMF075	SMD1812P075TF	mSMD075
JSMD1812-075/24	miniSMDC075F/24	1812L075/24	MF-MSMF075/24	SMD1812P075TF/24	mSMD075-24V
JSMD1812-075/33	miniSMDC075F/33	1812L075/33	MF-MSMF075/33X	SMD1812P075TF/33	mSMD075-33V
JSMD1812-110	-	1812L110	MF-MSMF110	SMD1812P110TF	mSMD110
JSMD1812-110/12	-	1812L110	-	-	-
JSMD1812-110/16	miniSMDC110F/16	1812L110/16	MF-MSMF110/16	SMD1812P110TF/16	mSMD110-16V
JSMD1812-110/24	miniSMDC110F/24	1812L110/24	MF-MSMF110/24X	SMD1812P110TF/24	mSMD110-24V
JSMD1812-110/33	-	1812L110/33	-	SMD1812P110TF/33	mSMD110-33V
JSMD1812-125	miniSMDC125F	-	MF-MSMF125	-	mSMD125
JSMD1812-125/12	-	-	-	-	-
JSMD1812-125/16	miniSMDC125F/16	1812L125/16	-	SMD1812P125TF/16	-
JSMD1812-260	miniSMDC260F	1812L260	-	-	mSMD260
JSMD1812-260/12	miniSMDC260F/12	1812L260/12	-	-	-
JSMD1812-260/16	miniSMDC260F/16	1812L260/16	MF-MSMF260	SMD1812P260TFT	-
JSMD1812-300	miniSMDC300F	1812L300	-	SMD1812P300TFT	mSMD300
JSMD1812-300/8	-	-	-	-	-

“Raychem” is a registered trademark of Tyco Electronics.

“Littelfuse” is a registered trademark of Littelfuse

“Multifuse” is a registered trademark of bourns,Inc.

“EVERFUSE” is a registered trademark of Polytronics Technology Corp.

“SEA-LAND” is a registered trademark of Sea-Land electronic corp.

Website: <http://www.jksemit.com>

For additional information, please contact your local Sales Representative.

©Copyright 2016, jksemit



is a registered trademark of jksemit All rights are reserved