

Single line bidirectional TVS diode for ESD protection

Datasheet - production data

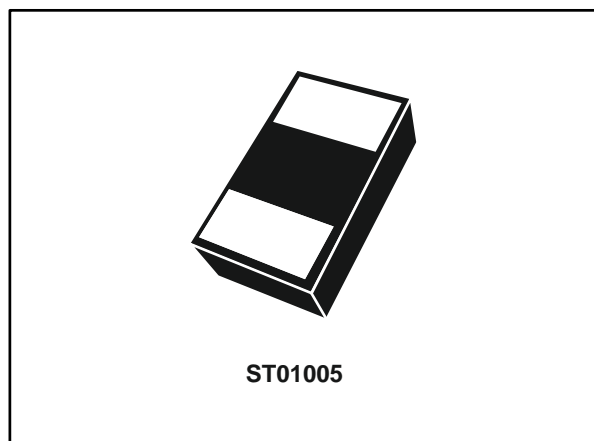

Features

- 01005 package size
- Ultra small PCB area: 0.08 mm²
- Bidirectional device
- Low capacitance: 7 pF
- Minimum breakdown voltage: $V_{BR} = 12\text{ V}$
- Halogen free and RoHS compliant

Complies with the following standards

- IEC 61000-4-2 level 4
 - 15 kV (air discharge)
 - 8 kV (contact discharge)

Applications

Where transient overvoltage protection in ESD sensitive equipment is required, such as:

- Tablet PCs, netbooks and notebooks
- Portable multimedia devices and accessories
- Digital cameras and camcorders
- Communication and highly integrated systems
- Smartphones, mobile phone and accessories

Description

The ESDAVLC12-1BV2 is a bidirectional single line TVS diode designed to protect the data lines or other I/O ports against ESD transients.

The device is ideal for applications where both reduced printed circuit board space and high ESD protection levels are required.

Figure 1: Functional diagram

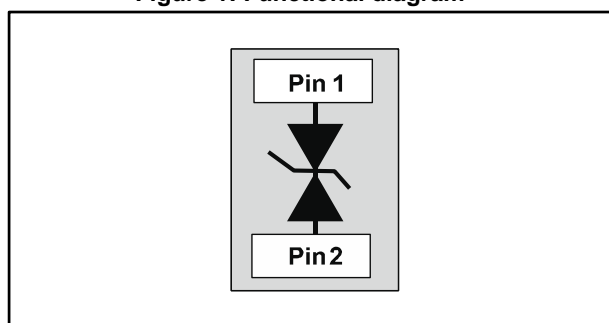

1 Characteristics

Table 1: Absolute ratings ($T_{amb} = 25\text{ }^{\circ}\text{C}$)

Symbol	Parameter		Value	Unit
V_{PP}	Peak pulse voltage	IEC 61000-4-2: Contact discharge	8	kV
		Air discharge	15	
I_{PP}	Peak pulse current	8/20 μ s	1.5	A
T_{stg}	Storage junction temperature range		-65 to +150	$^{\circ}\text{C}$
T_j	Maximum operating junction temperature		-40 to +125	
T_L	Maximum temperature for soldering during 10 s		260	$^{\circ}\text{C}$

Figure 2: Electrical characteristics (definitions)

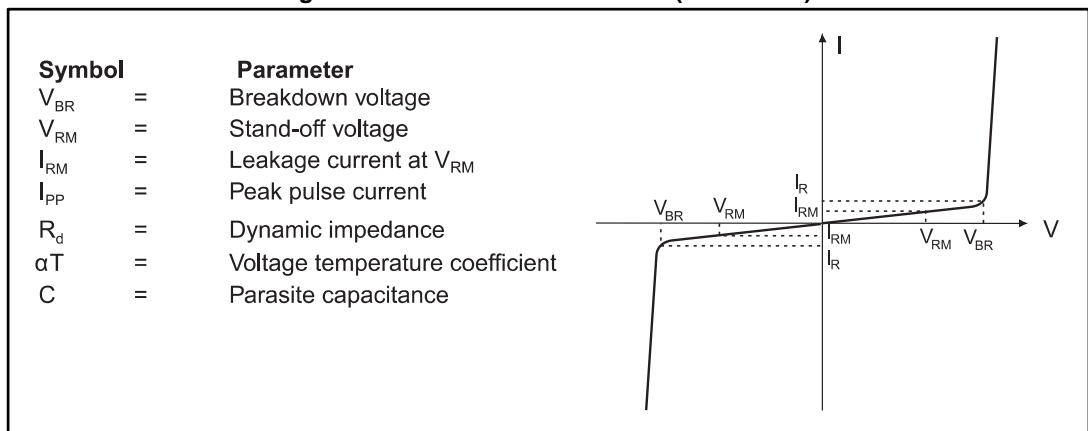
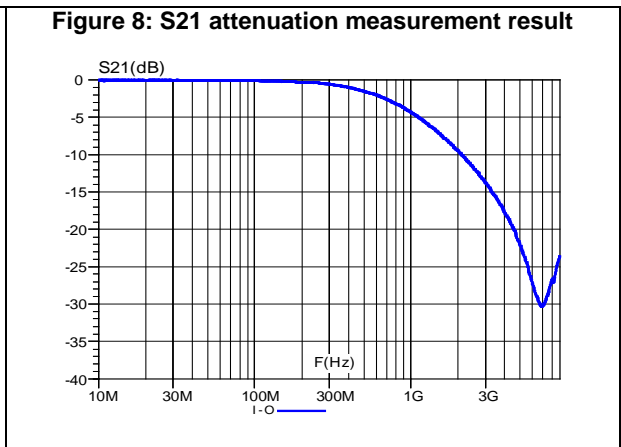
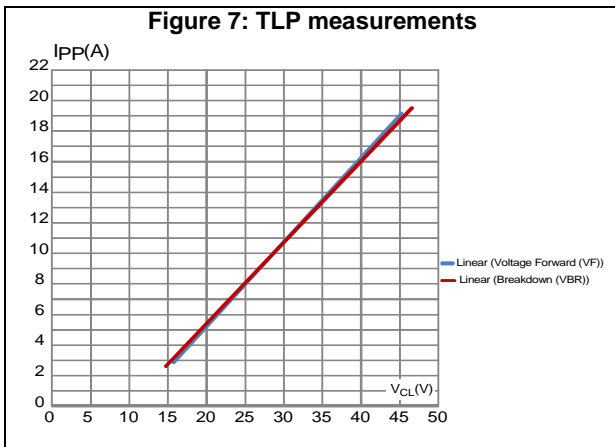
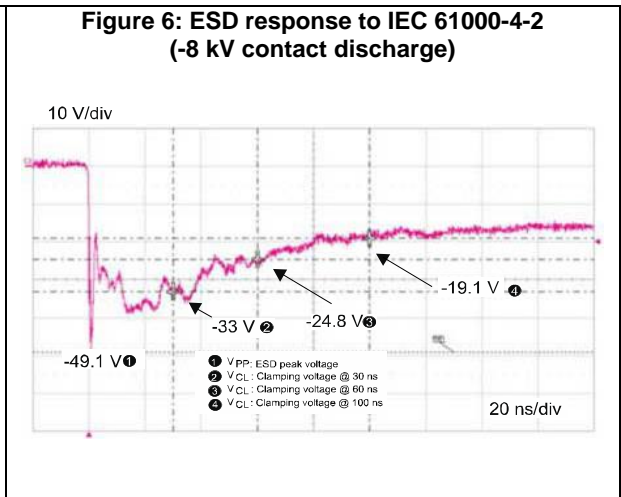
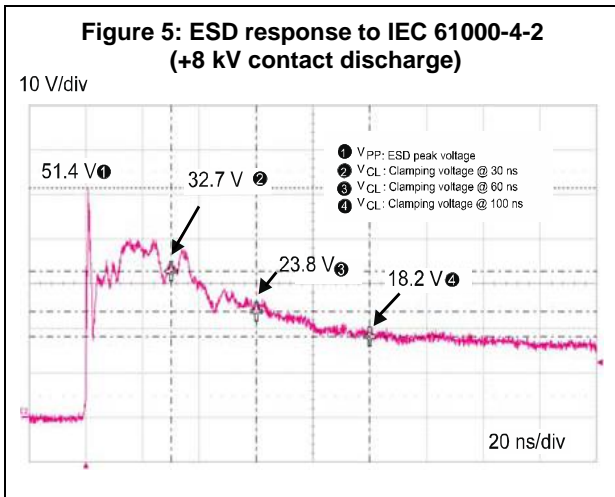
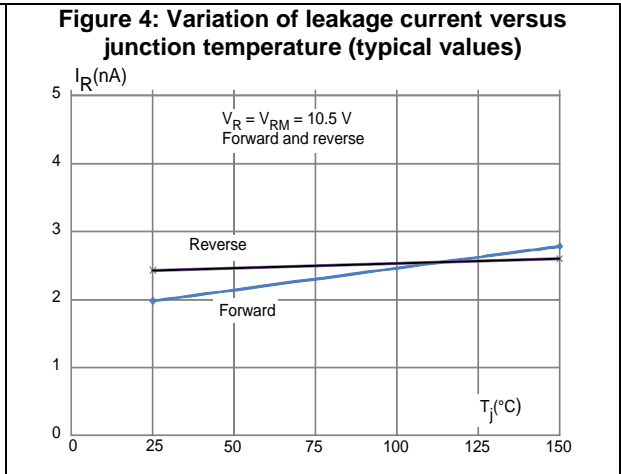
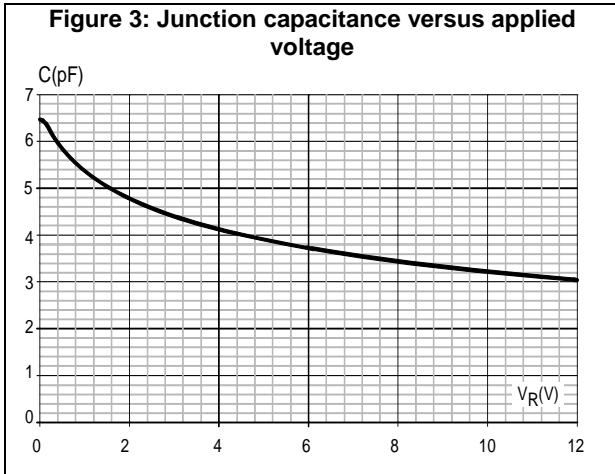

Table 2: Electrical characteristics ($T_{amb} = 25\text{ }^{\circ}\text{C}$)

Symbol	Test condition	Min.	Typ.	Max.	Unit
V_{BR}	$I_R = 1\text{ mA}$	12			V
I_{RM}	$V_{RM} = 10.5\text{ V}$		2.5	70	nA
R_d	Dynamic resistance, 100 ns pulse duration			2	Ω
V_{CL}	$I_{PP} = 1\text{ A}; 8/20\ \mu\text{s}$			20	V
V_{CL}	8 kV contact discharge after 30 ns IEC 61000-4-2		33		
C_{line}	$F = 1\text{ MHz}, V_R = 0\text{ V}$		7	10	pF

1.1 Characteristics (curves)



2 Package information

In order to meet environmental requirements, ST offers these devices in different grades of ECOPACK® packages, depending on their level of environmental compliance. ECOPACK® specifications, grade definitions and product status are available at: www.st.com. ECOPACK® is an ST trademark.

- Epoxy meets UL 94,V0
- Lead-free package

2.1 ST01005 package information

Figure 9: ST01005 package outline

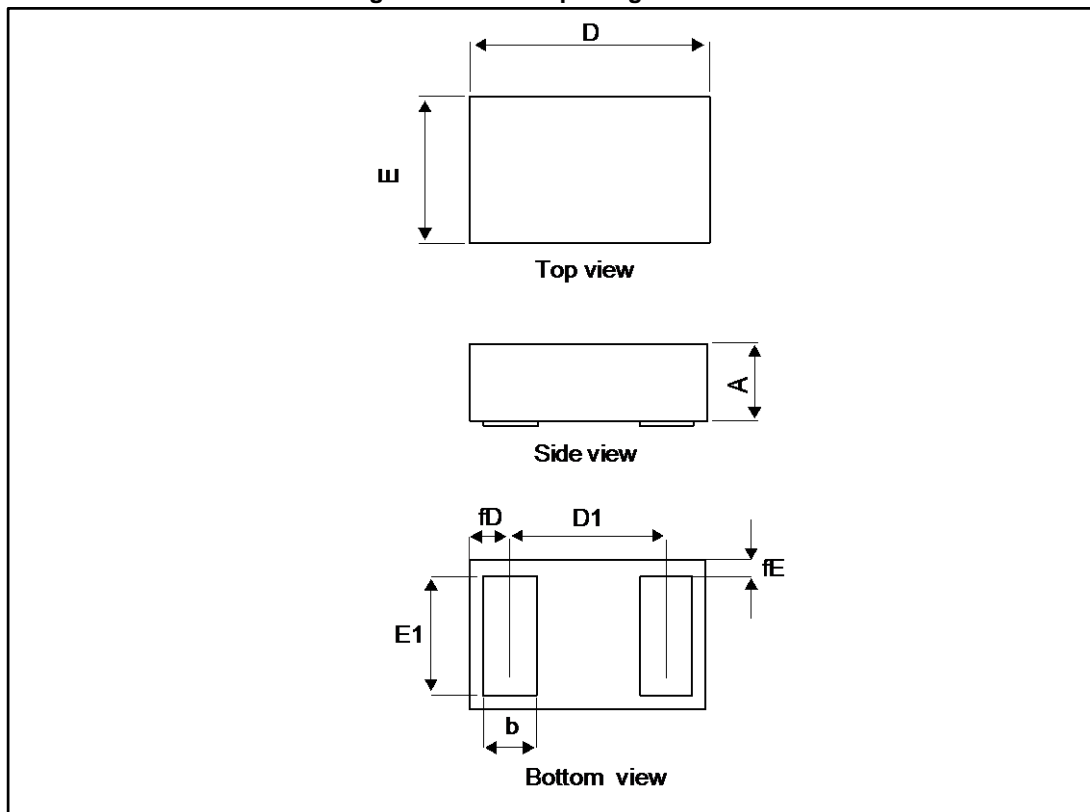

Table 3: ST01005 package mechanical data

Ref.	Dimensions					
	Millimeters			Inches		
	Min.	Typ.	Max.	Min.	Typ.	Max.
A	0.16	0.18	0.20	0.0063	0.0071	0.0079
b	0.094	0.104	0.114	0.0037	0.0041	0.0045
E	0.17	0.2	0.23	0.0067	0.0078	0.0091
E1	0.154	0.164	0.174	0.0061	0.0065	0.0069
D	0.37	0.40	0.43	0.0146	0.0157	0.0169
D1		0.26	0.6		0.0102	0.0236
fE	0.010	0.018	0.026	0.0004	0.0007	0.0010
fD	0.11	0.125	0.13	0.0043	0.0049	0.0051

Figure 10: Footprint recommendations, dimensions in mm (inches)

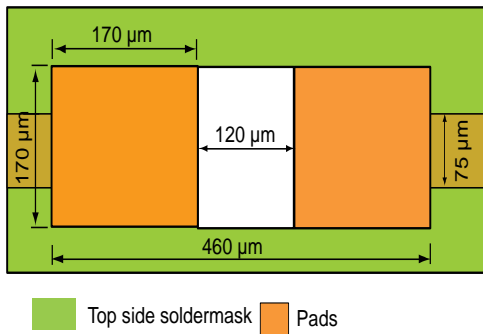
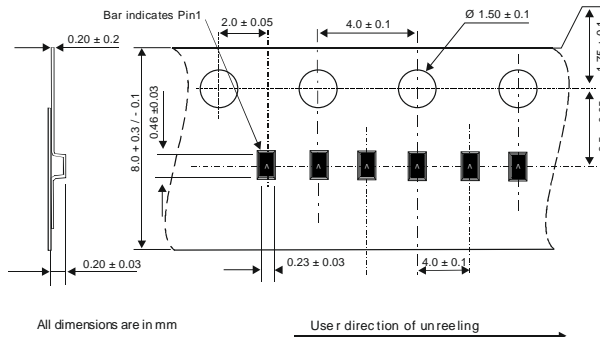

Figure 11: Marking layout



Product marking may be rotated by multiples of 90° for assembly plant differentiation. In no case should this product marking be used to orient the component for its placement on a PCB. Only pin 1 mark is to be used for this purpose.

Figure 12: Tape and reel specifications



3 Recommendation on PCB assembly

3.1 Stencil opening design

1. Reference design
 - a. Stencil opening thickness: 75 μm

Figure 13: Stencil opening dimensions

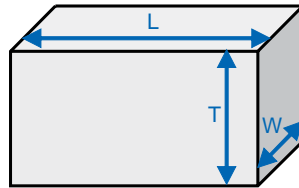
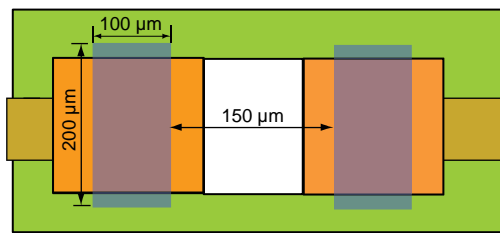

Figure 14: Recommended stencil window position in mm (inches)



Stencil opening

Stencil thickness: 75 μm (3 mils)
Use of solder paste type 4 mandatory

3.2 Solder paste

1. Halide-free flux qualification ROL0 according to ANSI/J-STD-004.
2. "No clean" solder paste is recommended.
3. Offers a high tack force to resist component movement during high speed.
4. Solder paste with fine particles: powder particle size is 20-38 μm .

3.3 Placement

1. Manual positioning is not recommended.
2. It is recommended to use the lead recognition capabilities of the placement system, not the outline centering
3. Standard tolerance of ± 0.05 mm is recommended.
4. 3.5 N placement force is recommended. Too much placement force can lead to squeezed out solder paste and cause solder joints to short. Too low placement force can lead to insufficient contact between package and solder paste that could cause open solder joints or badly centered packages.
5. To improve the package placement accuracy, a bottom side optical control should be performed with a high resolution tool.
6. For assembly, a perfect supporting of the PCB (all the more on flexible PCB) is recommended during solder paste printing, pick and place and reflow soldering by using optimized tools.

3.4 PCB design preference

1. To control the solder paste amount, the closed via is recommended instead of open vias.
2. The position of tracks and open vias in the solder area should be well balanced. A symmetrical layout is recommended, to avoid any tilt phenomena caused by asymmetrical solder paste due to solder flow away.

3.5 Reflow profile

Figure 15: ST ECOPACK® recommended soldering reflow profile for PCB mounting

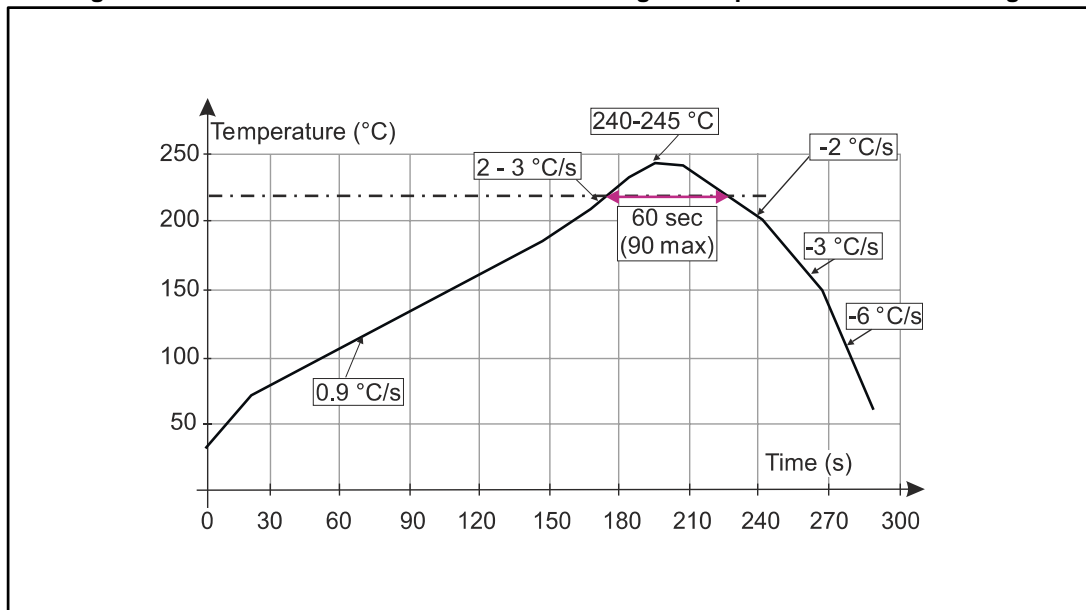

Minimize air convection currents in the reflow oven to avoid component movement. Maximum soldering profile corresponds to the latest IPC/JEDEC J-STD-020.

4 Ordering information

Figure 16: Ordering information scheme

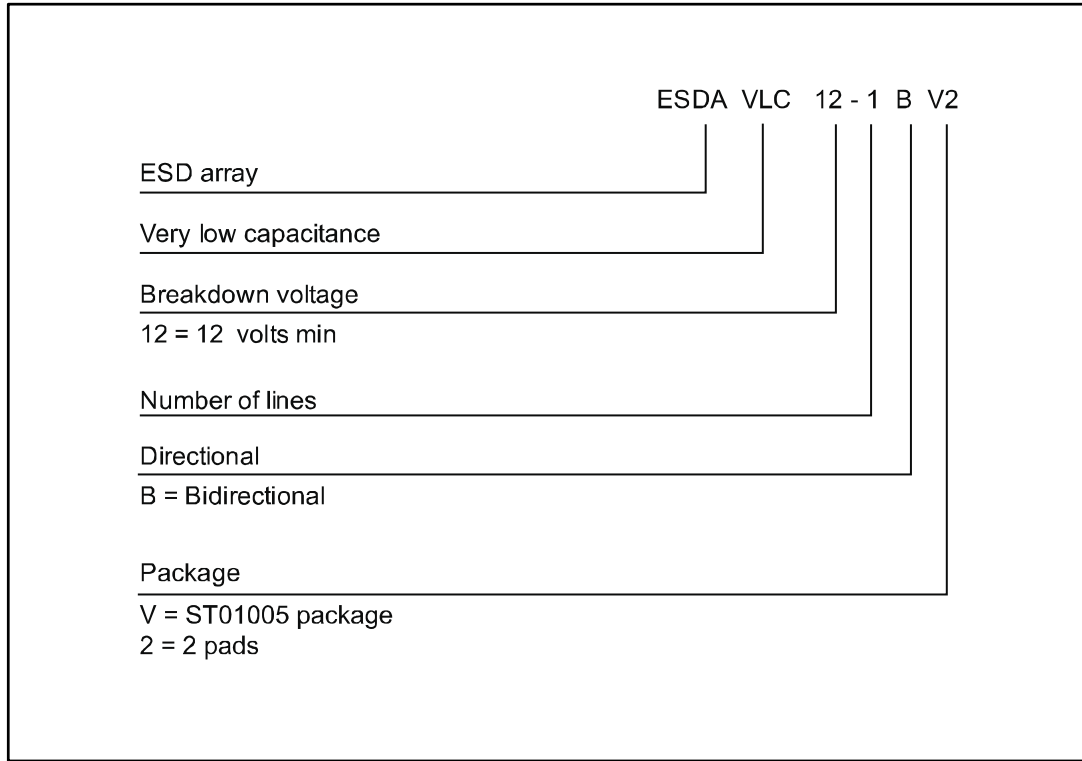

Table 4: Ordering information

Order code	Marking ⁽¹⁾	Package	Weight	Base qty.	Delivery mode
ESDAVLC12-1BV2	V	ST01005	0.043 mg	20000	Tape and reel

Notes:

⁽¹⁾The marking can be rotated by multiples of 90° to differentiate assembly location

5 Revision history

Table 5: Document revision history

Date	Revision	Changes
02-Dec-2014	1	Initial release.
23-May-2016	2	Updated Section 9: "Recommendation on PCB assembly" and Section 8.2: "ST01005 package information" .

IMPORTANT NOTICE – PLEASE READ CAREFULLY

STMicroelectronics NV and its subsidiaries ("ST") reserve the right to make changes, corrections, enhancements, modifications, and improvements to ST products and/or to this document at any time without notice. Purchasers should obtain the latest relevant information on ST products before placing orders. ST products are sold pursuant to ST's terms and conditions of sale in place at the time of order acknowledgement.

Purchasers are solely responsible for the choice, selection, and use of ST products and ST assumes no liability for application assistance or the design of Purchasers' products.

No license, express or implied, to any intellectual property right is granted by ST herein.

Resale of ST products with provisions different from the information set forth herein shall void any warranty granted by ST for such product.

ST and the ST logo are trademarks of ST. All other product or service names are the property of their respective owners.

Information in this document supersedes and replaces information previously supplied in any prior versions of this document.

© 2016 STMicroelectronics – All rights reserved