

ESD-R-SR Toroidal Cores for Round Cables for Low Frequency at 150 kHz (Bare, coated & with case)

Overview

The KEMET ESD-R-SR Series solid toroidal cores are designed for use on round cables. KEMET's unique core material enables high performance in low frequency range, at 150 kHz. Options are available in bare, coated and with case types. EMI cores are part of a family of passive components which address the issues of noise or electromagnetic interference (EMI) in circuits or systems

Applications

- Consumer electronics
- Air conditioners
- Power conditioners
- Refrigerators
- Washing machines
- Business multifunction printers
- Industrial equipment
- General purpose inverters

Benefits

- Proprietary high impedance core material for effective noise suppression at 150kHz
- Solid construction
- Large-size ring type
- Bare, coated and with case types available



Part Number System

| ESD- | R- | 31 | SR | -P |
|--------|------------|--|-------------------------|----------------------------|
| Series | Shape Type | Core Size Outer Dimension Code (mm) | Core Material | Type |
| ESD- | Ring | See Table 1 | SR = S15H SRH = S18H | Blank = Bare P = Coated |

Turns and Impedance Characteristics

When the desired performance of an EMI core cannot be obtained with a single pass through the core, the impedance characteristics can be changed with multiple turns.

A turn is counted by the number of lead-wire windings which pass through the inner hole of the core. Windings on the outside of the core do not count.

See Figure 1 for examples of one, two, and three turns.

Adding turns will result in higher impedance while also lowering the effective frequency range.

See Figure 2 for an example.

Core Material and Effective Frequency Range

There are two ferrite material options for KEMET EMI Cores: Nickel Zinc (Ni-Zn) and Manganese Zinc (Mn-Zn). Each core material has a different resistance and effective frequency range. The MnZn core material has a lower resistance compared to the Ni-Zn; therefore, adequate insulation is required before use.

The Ni-Zn core material is typically effective for frequencies in the MHz band range such as the FM-band, while the Mn-Zn core material is typically effective for the kHz band range such as the AM-band. See Figure 3.

It is recommended to measure the actual frequency range effectiveness in the target application.

Figure 1 – How to count turns

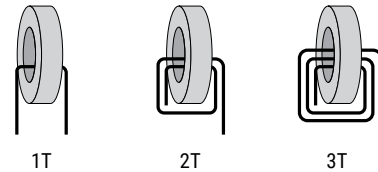

Figure 2 – Relationship between impedance and turn count. (Representative example: ESD-R-16C)

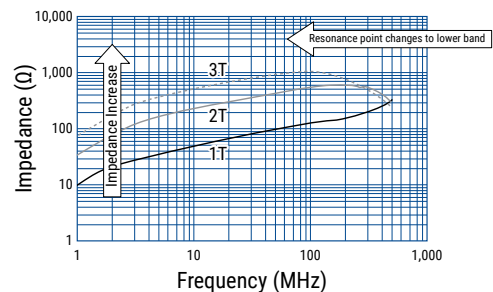
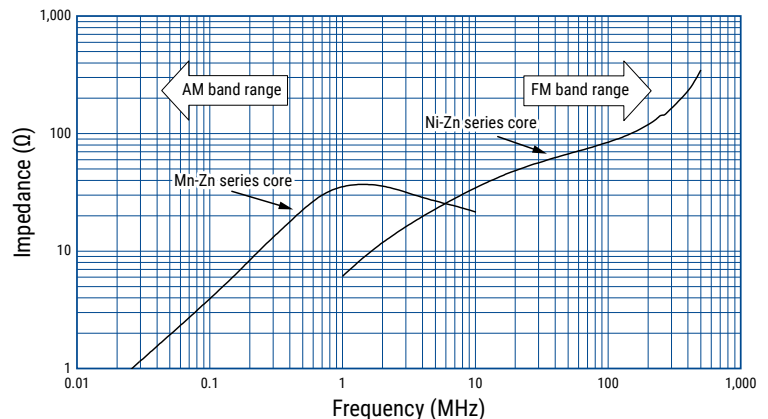

Figure 3 – Effective band range of Mn-Zn and Ni-Zn ferrite core material. (Representative example, measured with same-dimension ring core)



Magnetic Permeability of Ferrite Material

In order to achieve most efficient noise reduction, it is important to select the material according to the target frequency band. Depending on its magnetic permeability, a particular ferrite material will be effective in a certain frequency band. A schematic representation of the relationship between the magnetic permeability of each material and the corresponding effective band range is shown in Figure 1. Materials with higher magnetic permeability are effective in the lower frequency range, while those with lower magnetic permeability are effective in the higher frequency range. Thus, Mn-Zn products are mainly used for reducing conduction noise, while Ni-Zn products are commonly used for radiation noise countermeasures.

The effective frequency range varies depending on core shape, size and number of windings. This frequency dependence of the magnetic permeability as shown in the figure serves for reference purposes only and it should be tested on the actual device to determine its effectiveness.

S18H, S15H, 10H, 7H, 5H, 1400L and 700L are KEMET's proprietary ferrite material names. Other materials can also be available on request.

Figure 4 - Relationship between the magnetic permeability of each material and its effective frequency range

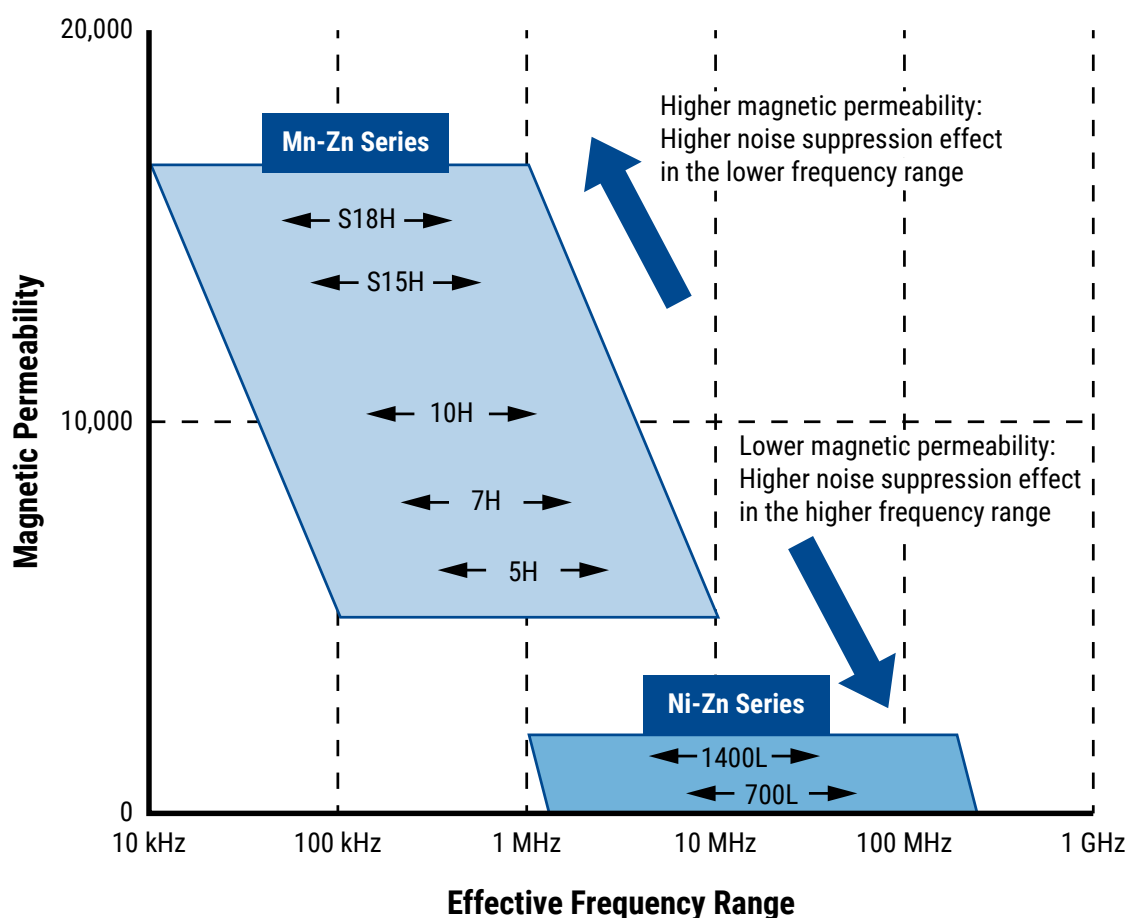

Environmental Compliance

All KEMET EMI cores are RoHS compliant.



Dimensions – Millimeters

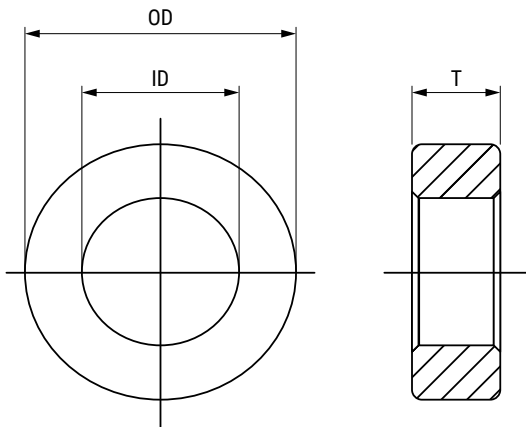

See Table 1 for dimensions

Installation Example

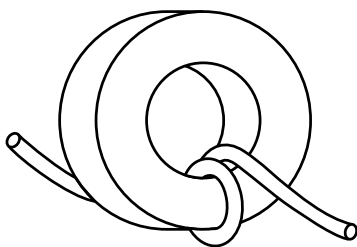

Performance Characteristics

| Item | Performance Characteristics |
|-----------------------------|-----------------------------|
| Operating temperature | -25°C to +85°C |
| Frequency range | Low frequency |
| Outer diameter | 31.0 – 59.0 mm |
| Inner diameter | 19.0 – 36.0 mm |
| Thickness | 12.7 – 21.0 mm |
| Type | Bare, coated, and case |
| Case flame resistant rating | UL94 V-2 |
| Material | MnZn S15H |

Table 1 – Ratings & Part Number Reference

| Part Number | Dimensions (mm) | | | Weight (g) | Type | Color | Compatible Toroid Core (Bare Type) | Frequency Range ¹ | | Material | |
|--------------|-----------------|--------------|--------------|------------|--------|----------------------|------------------------------------|------------------------------|---------------------------|----------|------|
| | OD | ID | T | | | | | ≤ 10 MHz (AM band range) | ≤ 300 MHz (FM band range) | MnZN | NiZn |
| ESD-R-31SR | 31.0 ±0.8 | 20.0 ±0.8 | 14.9 ±0.5 | 32.5 | Bare | – | – | X | | S15H | – |
| ESD-R-38SR | 38.0 ±0.8 | 19.0 ±0.8 | 12.7 ±0.5 | 52.5 | Bare | – | – | X | | S15H | – |
| ESD-R-47SR | 47.0 ±1.0 | 27.0 ±0.8 | 15.0 ±0.5 | 83.4 | Bare | – | – | X | | S15H | – |
| ESD-R-57SR | 57.0 ±1.5 | 36.0 ±1.0 | 20.0 ±0.5 | 139.5 | Bare | – | – | X | | S15H | – |
| ESD-R-31SR-P | 32.0 Maximum | 19.0 Minimum | 16.0 Maximum | 32.9 | Coated | Gray | – | X | | S15H | – |
| ESD-R-38SR-P | 39.5 Maximum | 18.0 Minimum | 14.0 Maximum | 53.3 | Coated | Gray | – | X | | S15H | – |
| ESD-R-47SR-P | 48.5 Maximum | 26.0 Minimum | 16.0 Maximum | 84.3 | Coated | Gray | – | X | | S15H | – |
| ESD-R-57SR-P | 59.0 Maximum | 34.0 Minimum | 21.0 Maximum | 141.5 | Coated | Gray | – | X | | S15H | – |
| ESD-R-47SRH | 51.0 Maximum | 24.4 ±1.0 | 19.0 Maximum | 92.0 | Case | White with blue tape | – | X | | S18H | – |

¹ Frequency range is for reference only. Please test with actual device before use.

Impedance vs. Frequency

Bare Type

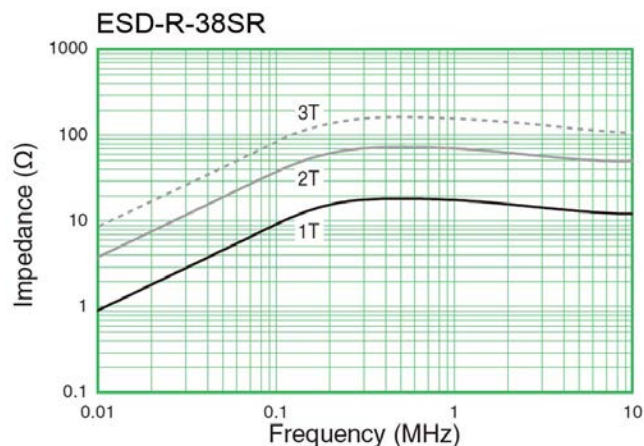
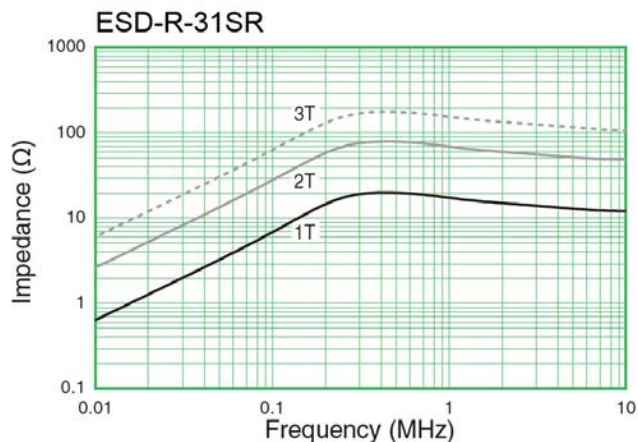

Impedance vs. Frequency cont.

Bare Type

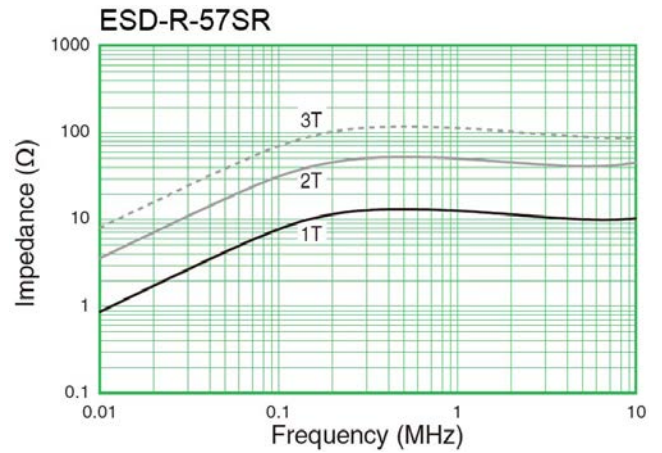
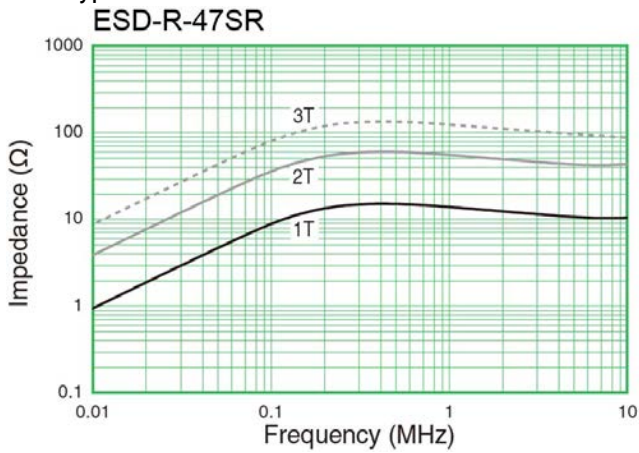

Coated Type

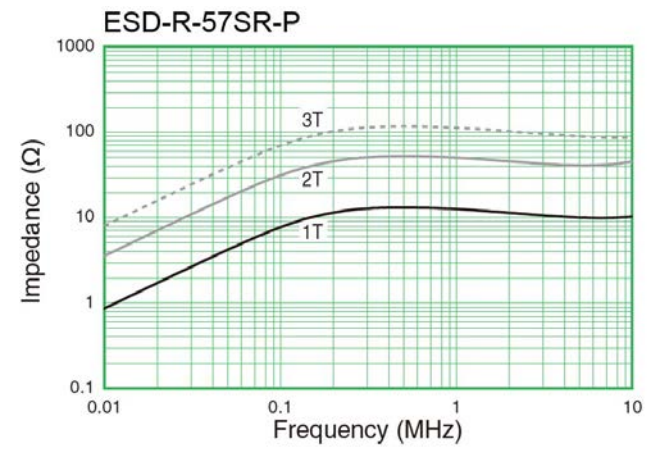
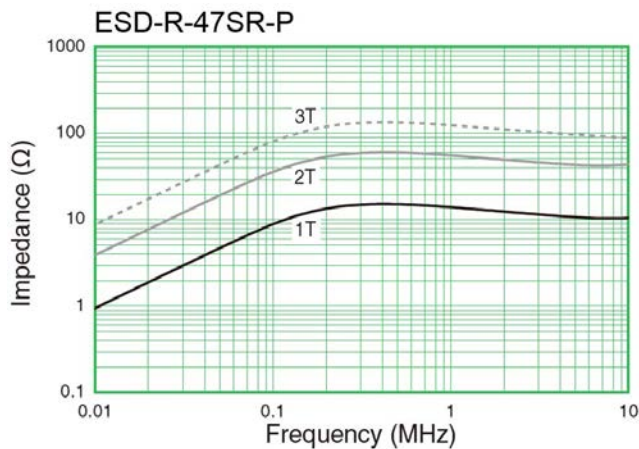
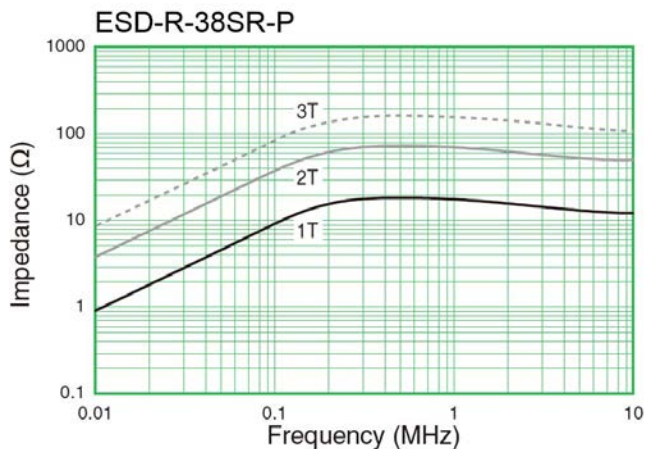
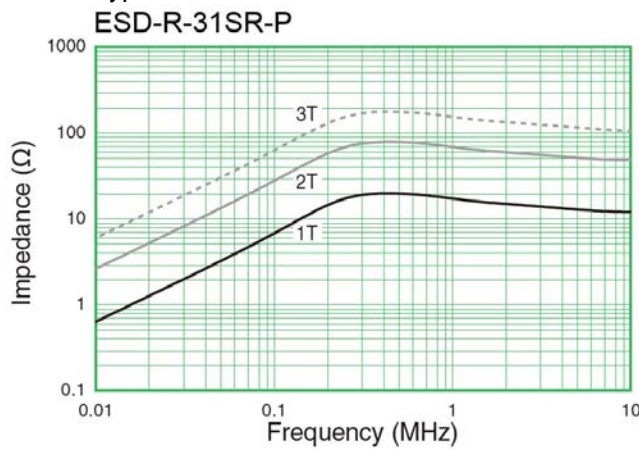

Impedance vs. Frequency cont.

Case Type

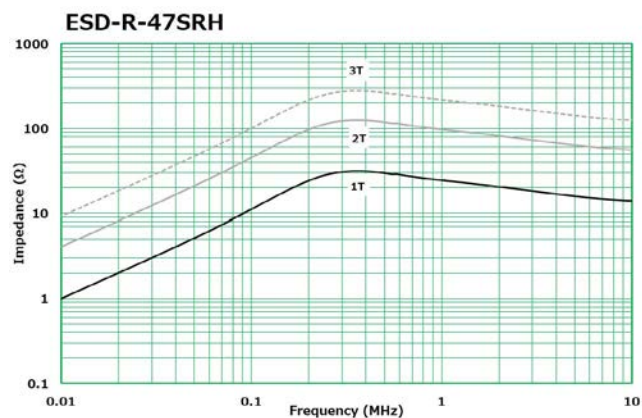

Packaging

| Part Number | Packaging Type | Pieces per Box |
|--------------|----------------|----------------|
| ESD-R-31SR | Tray | 300 |
| ESD-R-38SR | | 200 |
| ESD-R-47SR | | 100 |
| ESD-R-57SR | | 60 |
| ESD-R-31SR-P | | 300 |
| ESD-R-38SR-P | | 200 |
| ESD-R-47SR-P | | 100 |
| ESD-R-57SR-P | | 60 |
| ESD-R-47SRH | | 100 |

Handling Precautions

EMI Cores should be stored in normal working environments. While the EMI Cores themselves are quite robust in other environments, avoid exposure to high temperatures, high humidity, corrosive atmospheres and long term storage for case, snap-on and split types.

KEMET recommends that maximum storage temperature not exceed 40°C and maximum storage humidity not exceed 75% relative humidity. Atmospheres should be free of chlorine, sulfur and alkali bearing compounds. Avoid also storage near strong magnetic fields as this might magnetize the product.

Temperature fluctuations should be minimized to avoid condensation or cracks on the parts. Mechanical shocks can bring to cracks as well.

Export Control

For customers in Japan

For products that are controlled items subject to the “Foreign Exchange and Foreign Trade Law” of Japan, the export license specified by the law is required for export.

For customers outside Japan

EMI Core products should not be used or sold for use in the development, production, stockpiling or utilization of any conventional weapons or mass-destructive weapons (nuclear weapons, chemical or biological weapons, or missiles), or any other weapons.

KEMET Electronics Corporation Sales Offices

For a complete list of our global sales offices, please visit www.kemet.com/sales.

Disclaimer

All product specifications, statements, information and data (collectively, the "Information") in this datasheet are subject to change. The customer is responsible for checking and verifying the extent to which the Information contained in this publication is applicable to an order at the time the order is placed. All Information given herein is believed to be accurate and reliable, but it is presented without guarantee, warranty, or responsibility of any kind, expressed or implied.

Statements of suitability for certain applications are based on KEMET Electronics Corporation's ("KEMET") knowledge of typical operating conditions for such applications, but are not intended to constitute – and KEMET specifically disclaims – any warranty concerning suitability for a specific customer application or use. The Information is intended for use only by customers who have the requisite experience and capability to determine the correct products for their application. Any technical advice inferred from this Information or otherwise provided by KEMET with reference to the use of KEMET's products is given gratis, and KEMET assumes no obligation or liability for the advice given or results obtained.

Although KEMET designs and manufactures its products to the most stringent quality and safety standards, given the current state of the art, isolated component failures may still occur. Accordingly, customer applications which require a high degree of reliability or safety should employ suitable designs or other safeguards (such as installation of protective circuitry or redundancies) in order to ensure that the failure of an electrical component does not result in a risk of personal injury or property damage.

Although all product-related warnings, cautions and notes must be observed, the customer should not assume that all safety measures are indicated or that other measures may not be required.

KEMET is a registered trademark of KEMET Electronics Corporation.