

PLEASE CHECK WWW.MOLEX.COM FOR LATEST PART INFORMATION

Part Number: [0877153914](#)
Status: **Active**
Overview:
Description: 1.00mm (.039") Pitch, PCI Express* Connector, 280 Circuits, Nylon 4/6 Glass-filled, Black Housing, Phosphor Bronze, Gold (Au) Flash, with Plastic Pegs, 3.00mm (.118") Solder-tail, Lead Free

Agency Certification

CSA LR19980

General

Product Family Edge Card Connectors
 Series 87715
 Component Type Edgecard to PCB
 Overview pci_express_card_edge_connector
 Product Name PCI Express*

Physical

Circuits (Loaded) 280
 Circuits (maximum) 280
 Circuits Detail All Signal
 Durability (mating cycles max) 50
 Entry Angle Vertical (Top Entry)
 Flammability 94V-0
 Keying to Mating Part Yes
 Material - Plating Mating Gold
 Material - Plating Termination Tin
 PC Tail Length (in) 0.118 In
 PC Tail Length (mm) 3.00 mm
 PCB Locator Yes
 PCB Retention Yes
 PCB Thickness Recommended (in) 0.093 In
 PCB Thickness Recommended (mm) 2.40 mm
 Packaging Type Tray
 Pitch - Mating Interface (in) 0.039 In
 Pitch - Mating Interface (mm) 1.00 mm
 Pitch - Term. Interface (in) 0.039 In
 Pitch - Term. Interface (mm) 1.00 mm
 Polarized to Mating Part Yes
 Temperature Range - Operating -55°C to +85°C
 Termination Interface: Style Through Hole

Electrical

Current - Maximum per Contact 1.1A
 Voltage - Maximum 50V AC (RMS)/DC

Solder Process Data

Lead-free Process Capability Wave Capable (TH only)
 Process Temperature max. C 260

Material Info

Reference - Drawing Numbers

Packaging Specification PK-87715-206
 Product Specification PS-87715-206
 Sales Drawing SD-87715-206
 Test Summary TS-87715-206

EU RoHS
ELV and RoHS
Compliant
REACH SVHC
 Not Reviewed
Halogen-Free
Status
Not Reviewed

China RoHS



Need more information on product environmental compliance?

Email productcompliance@molex.com
 For a multiple part number RoHS Certificate of Compliance, [click here](#)

Please visit the [Contact Us](#) section for any non-product compliance questions.

Search Parts in this Series
 87715Series

Mates With
 PCI Express Card

| * PCI Express is a registered trademark of PCI-SIG®

This document was generated on 06/04/2010

PLEASE CHECK WWW.MOLEX.COM FOR LATEST PART INFORMATION

7 6 5 4 3 2 1

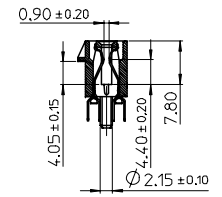
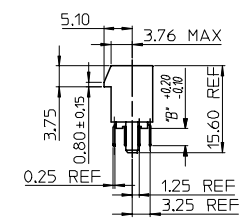
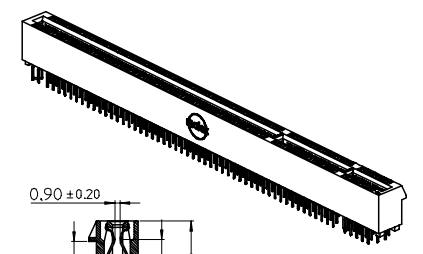
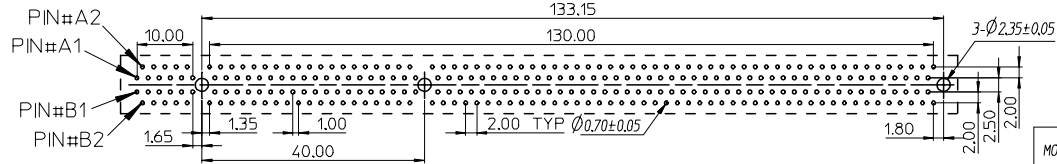
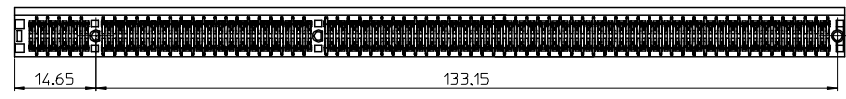
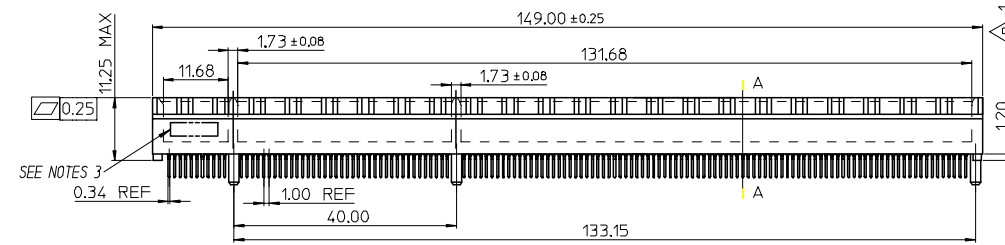
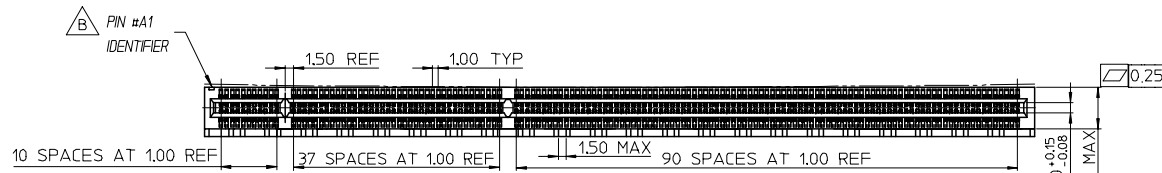

SECTION A-A

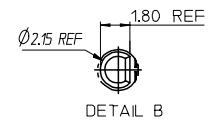

- NOTES:
 1.MATERIALS:
 1-1.HOUSING:SEE TABLE GLASS FIBER FILLED UL94V-0
 COLOR:SEE TABLE
 1-2.CONTACT:SEE TABLE
 2.PLATING:
 2-1.CONTACT AREA:SEE TABLE
 2-2.SOLDER TAIL:SEE TABLE
 2-3.UNDER PLATING:SEE TABLE
 3.DATE CODE:TO BE PRINTED
 4.PRODUCT SPECIFICATION REFER TO PS-87715-200
 5.PACKAGE SPECIFICATION REFER TO PK-87715-206
 6.TEST SUMMARY:REFER TO TS-87715-206
 7.LEAD FREE AND ROHS COMPLIANT.

MOLEX PIN	CIRCUIT SIZE	HOUSING MATERIAL	HOUSING COLOR	TERMINAL MATERIAL	CONTACT PLATING	SOLDERTAIL PLATING	DIMB*
87715-3914	280	NYLON 46	BLACK	PHOSPHOR BRONZE	GOLD FLASH	100 MICRORINCH TIN OVER 50 MICRORINCH NICKEL OVERALL	3.00
87715-3915	280	NYLON 46	BLACK	PHOSPHOR BRONZE	15 MICRORINCH	100 MICRORINCH TIN OVER 50 MICRORINCH NICKEL OVERALL	3.00
87715-3916	280	NYLON 46	BLACK	PHOSPHOR BRONZE	30 MICRORINCH	100 MICRORINCH TIN OVER 50 MICRORINCH NICKEL OVERALL	3.00
87715-3917	280	NYLON 46	BLACK	PHOSPHOR BRONZE	GOLD FLASH	100 MICRORINCH TIN OVER 50 MICRORINCH NICKEL OVERALL	2.54
87715-3918	280	NYLON 46	BLACK	PHOSPHOR BRONZE	15 MICRORINCH	100 MICRORINCH TIN OVER 50 MICRORINCH NICKEL OVERALL	2.54
87715-3919	280	NYLON 46	BLACK	PHOSPHOR BRONZE	30 MICRORINCH	100 MICRORINCH TIN OVER 50 MICRORINCH NICKEL OVERALL	2.54

EWR 2006-0005 & 2006-0019 2005-0094 EC NO: SH2006-0100 DRWN:ALL IN 2006/05/15 CHKD: 2006/05/15 APPR:WWSCHANG 2006/05/16	QUALITY SYMBOLS ▽=0 ▽=0	GENERAL TOLERANCES (UNLESS SPECIFIED)		DIMENSION STYLE MM ONLY		SCALE	DESIGN UNITS	THIRD ANGLE PROJECTION		
			mm	INCH	DRAWN BY	DATE	TITLE	1.0 EDGE CARD 280 CKT VERTICAL DIP CONNECTOR (LEAD FREE VERSION)		
		4 PLACES	± ---	± ---	TOM	2005/03/22	MOLEX INCORPORATED			
		3 PLACES	± ---	± ---	CHECKED BY	DATE		DOCUMENT NO.	SHEET NO.	
	2 PLACES	± 0.25	± ---	ALL IN	2005/03/22	SD-87715-206	1 OF 2			
	1 PLACE	± 0.25	± ---	APPROVED BY	DATE	THIS DRAWING CONTAINS INFORMATION THAT IS PROPRIETARY TO MOLEX INCORPORATED AND SHOULD NOT BE USED WITHOUT WRITTEN PERMISSION				
	ANGULAR ± 3 °		MATERIAL NO.	SEE TABLE						
	DRAFT WHERE APPLICABLE MUST REMAIN WITHIN DIMENSIONS			SIZE						

6 5 4 3 2 1

7 6 5 4 3 2 1

E

D

C

B

A

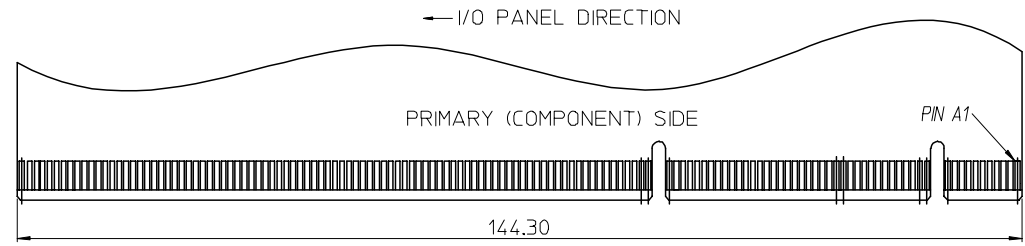
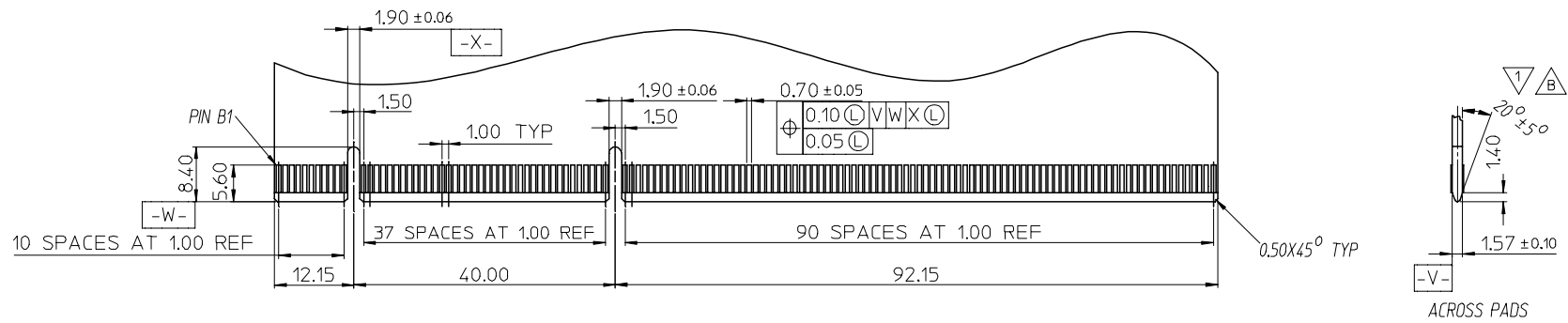

△ I/O PANEL → DIRECTION
DAUGHTER CARD
SECONDARY (SOLDER) SIDE

△ CHAMFER EDGES MUST BE FREE OF CUTTING BURRS.

SEE SHEET 1 EC NO: SH2006-0100 DRWN: ALL IN CHKD: APPR: WWSCHANG 2006/05/15 2006/05/15 2006/05/16	DESCRIPTION REV	QUALITY SYMBOLS	GENERAL TOLERANCES (UNLESS SPECIFIED)		DIMENSION STYLE MM ONLY		SCALE 1:1	DESIGN UNITS METRIC	THIRD ANGLE PROJECTION		
		▽ = 0 ◻ = 0	mm	INCH	DRAWN BY TOM	DATE 2005/03/22	TITLE 1.0 EDGE CARD 280 CKT VERTICAL DIP CONNECTOR (LEAD FREE VERSION)				
			4 PLACES ± ---	± ---	CHECKED BY ALL IN	DATE 2005/03/22					
			3 PLACES ± ---	± ---	APPROVED BY WWSCHANG	DATE 2005/03/22					
			2 PLACES ± 0.25	± ---	MATERIAL NO. SEE TABLE	DOCUMENT NO. SD-87715-206					
	1 PLACE ± 0.25	± ---	DRAFT WHERE APPLICABLE MUST REMAIN WITHIN DIMENSIONS		SIZE A 4		THIS DRAWING CONTAINS INFORMATION THAT IS PROPRIETARY TO MOLEX INCORPORATED AND SHOULD NOT BE USED WITHOUT WRITTEN PERMISSION				
			ANGULAR ± 3 °				MOLEX MOLEX INCORPORATED		SHEET NO. 2 OF 2		

6 5 4 3 2 1