

ARE1-xxx0-00000**High Power Infrared Emitting Diodes**

Features

- Available in peak wavelengths: 850 nm and 940 nm
- High radiant intensity
- High radiant power
- Low forward voltage
- Typical viewing angles: 90° and 150°
- Compatible with industrial reflow soldering process
- MSL 3

Applications

- Infrared illumination for cameras
- Surveillance systems

Figure 1: Package Drawing

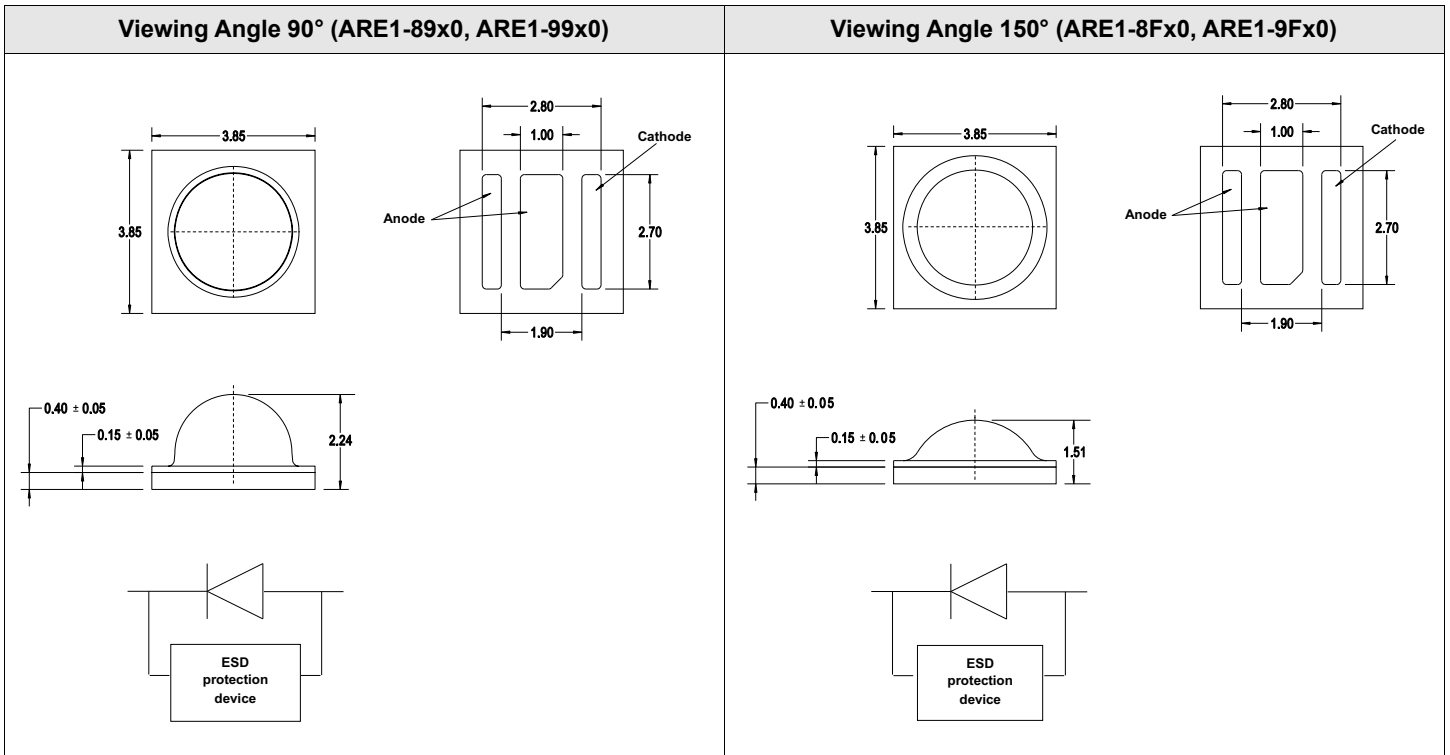

NOTE:

1. All dimensions in millimeters (mm).
2. Tolerance is ± 0.1 mm unless otherwise specified.

Device Selection Guide ($T_J = 25^\circ\text{C}$, $I_F = 1\text{A}$)

Part Number	Peak Wavelength, λ_{peak} (nm)	Radiant Intensity, I_e (mW/sr) ^{a,b}		Radiant Flux, Φ_e (mW) ^c	Viewing Angle, $2\theta_{1/2}$ (°) ^d
		Min.	Max.	Typ.	Typ.
ARE1-89C0-00000	850	160	450	685	90
ARE1-89D0-00000	850	250	600	800	90
ARE1-8930-00000	850	630	1000	1340	90
ARE1-8FC0-00000	850	100	350	630	150
ARE1-8FD0-00000	850	150	400	800	150
ARE1-8F30-00000	850	200	500	1270	150
ARE1-99D0-00000	940	160	450	590	90
ARE1-9930-00000	940	320	850	935	90
ARE1-9F30-00000	940	160	400	970	150

- a. The radiant intensity, I_e is measured at the mechanical axis of the package and it is tested with a single current pulse condition ($t_p = 10$ ms). The actual peak of the spatial radiation pattern may not be aligned with the axis.
- b. Tolerance is $\pm 15\%$.
- c. The radiant flux, Φ_e is the total flux output as measured with an integrating sphere at a single current pulse condition ($t_p = 10$ ms).
- d. $\theta_{1/2}$ is the off-axis angle where the luminous intensity is half of the peak intensity.

Absolute Maximum Ratings

Parameters	ARE1-8xC0	ARE1-8xD0	ARE1-8x30	ARE1-9xD0	ARE1-9x30	Units
DC Forward Current ^a	1000	1000	1000	1000	1000	mA
Peak Forward Current ^b	3000	3000	3000	3000	3000	mA
Power Dissipation	2500	2500	3600	2500	3400	mW
Reverse Voltage	Not designed for reverse bias operation					
LED Junction Temperature	115	145	115	115	115	°C
Operating Temperature Range	-40 to +85	-40 to +100	-40 to +85	-40 to +85	-40 to +85	°C
Storage Temperature Range	-40 to +100	-40 to +100	-40 to +100	-40 to +100	-40 to +100	°C

- a. Derate linearly as shown in [Figure 8](#), [Figure 9](#), [Figure 10](#), and [Figure 11](#).
- b. Duty factor = 10%, frequency = 1kHz.

Optical and Electrical Characteristics ($T_J = 25^\circ\text{C}$)

Parameters	Min.	Typ.	Max.	Units	Test Condition
Forward Voltage, V_F^a				V	$I_F = 1\text{A}$
ARE1-8xC0	1.4	1.8	2.5		
ARE1-8xD0	1.4	1.8	2.5		
ARE1-8x30	2.7	3.2	3.6		
ARE1-9xD0	1.4	1.8	2.5		
ARE1-9x30	2.5	3.0	3.4		
Reverse Voltage, V_R	Not designed for reverse bias				
Thermal Resistance, $R_{\theta J-S}^b$	—	10	—	$^\circ\text{C/W}$	LED junction to solder point

a. Forward voltage tolerance is $\pm 0.1\text{V}$.

b. Thermal resistance from the LED junction to the solder point.

Part Numbering System

A R E 1 -

x_1	x_2	x_3
-------	-------	-------

 0 - 0 0 0 0 0

Code	Description	Option	
x_1	Peak Wavelength	8	850 nm
		9	940 nm
x_2	Viewing Angle	9	90°
		F	150°
x_3	Brightness Option	C	Single junction normal brightness
		D	Single junction high brightness
		3	Double junction high brightness

Part Number Example

ARE1-89D0-00000

x_1 : 8 — Peak wavelength 850nm
 x_2 : 9 — Viewing angle typical 90°
 x_3 : D — Single junction high brightness

Figure 2: Spectral Power Distribution

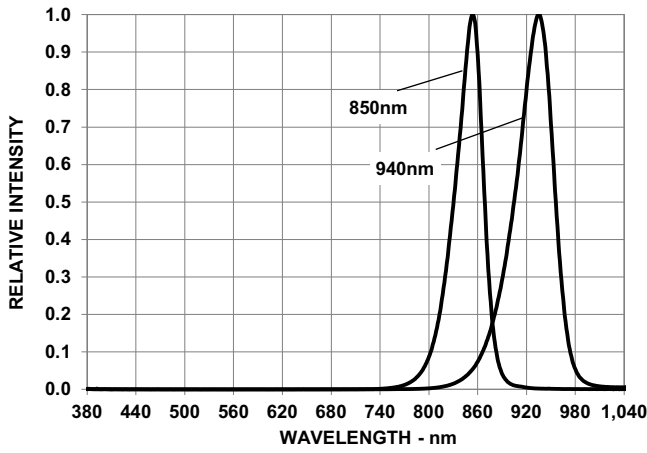

Figure 3: Forward Current vs. Forward Voltage

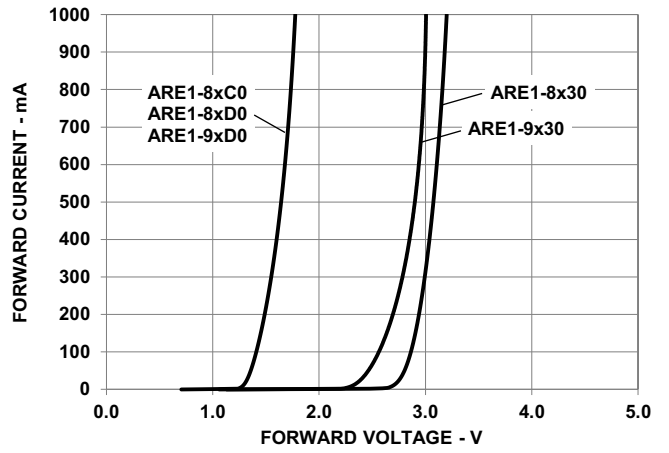

Figure 4: Relative Radiant Flux vs. Mono Pulse Current

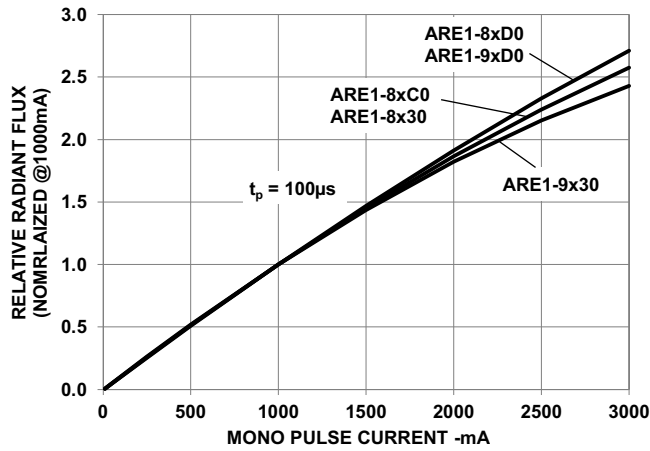

Figure 5: Relative Light Output vs. Junction Temperature

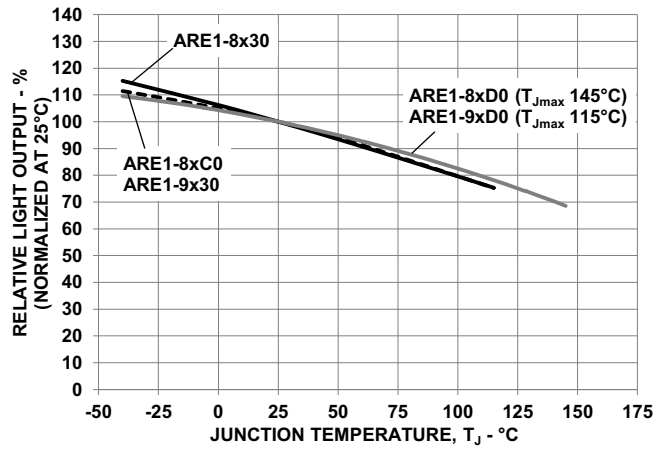

Figure 6: Forward Voltage Shift vs. Junction Temperature

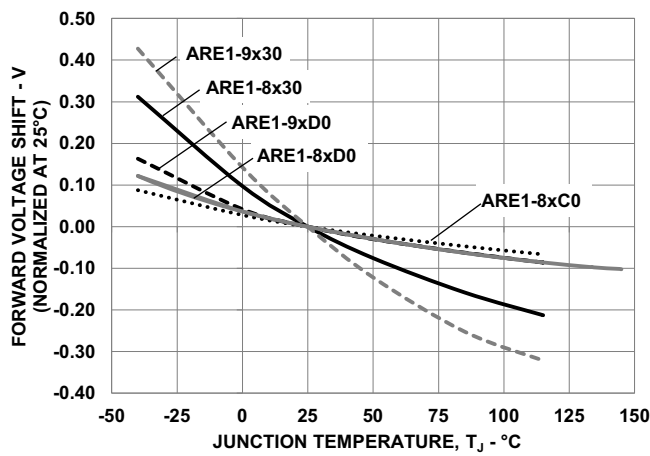

Figure 7: Radiation Pattern

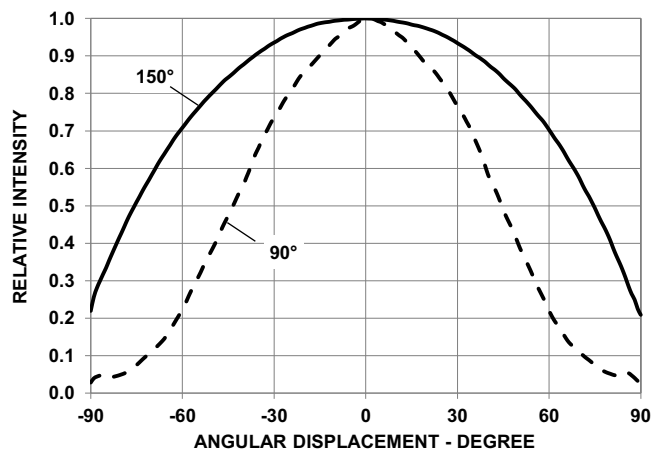

Figure 8: Maximum Forward Current vs. Ambient Temperature for ARE1-8xC0 and ARE1-9xD0

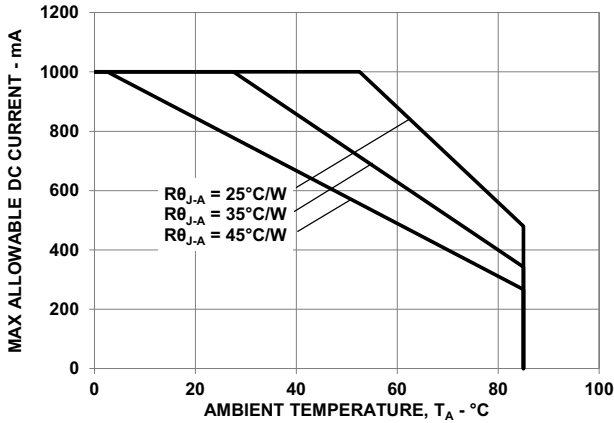

Figure 9: Maximum Forward Current vs. Ambient Temperature for ARE1-8xD0

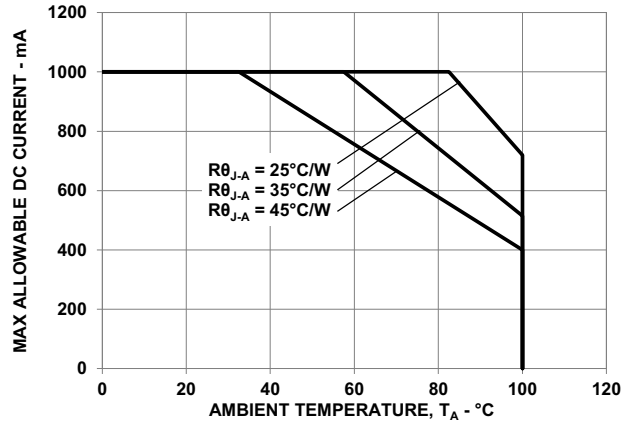

Figure 10: Maximum Forward Current vs. Ambient Temperature for ARE1-8x30

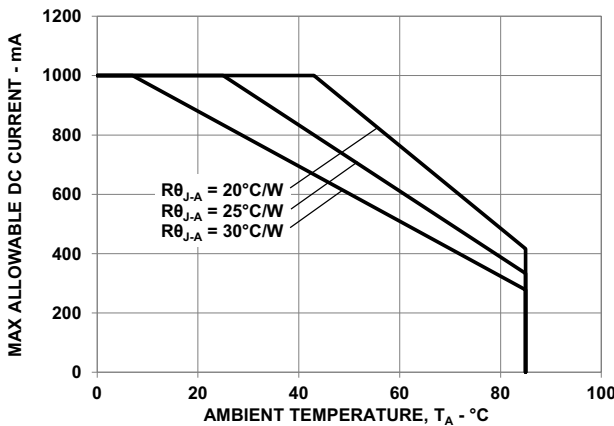

Figure 11: Maximum Forward Current vs. Ambient Temperature for ARE1-9x30

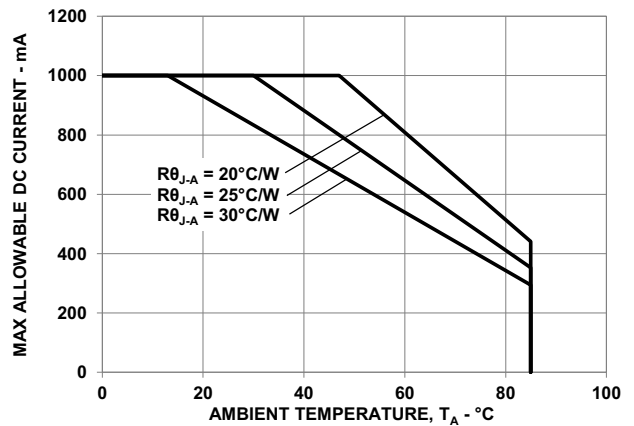

Figure 12: Maximum Forward Current vs. Solder Point Temperature

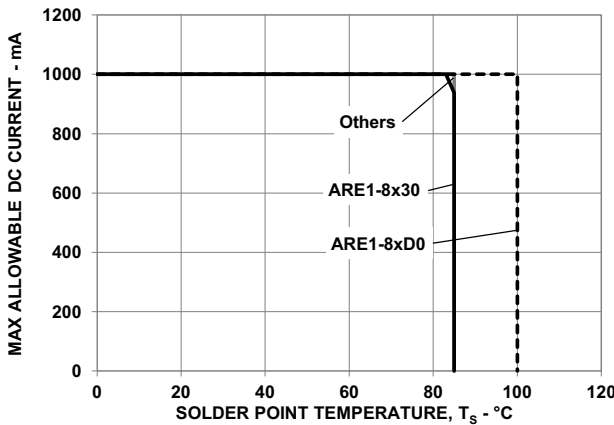
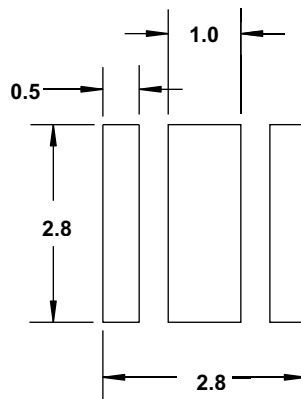
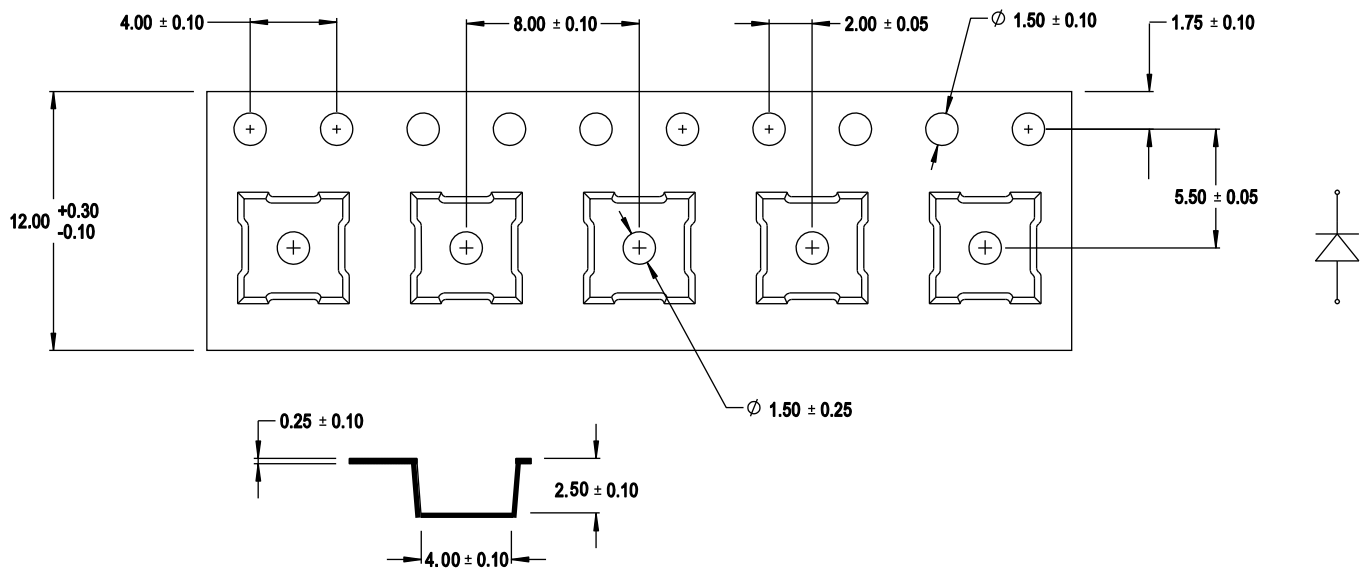

Figure 13: Recommended Soldering Land Pattern



NOTE: All dimensions are in millimeters (mm).

Figure 14: Carrier Tape Dimensions



NOTE: All dimensions in millimeters (mm).

Figure 15: Reel Dimensions

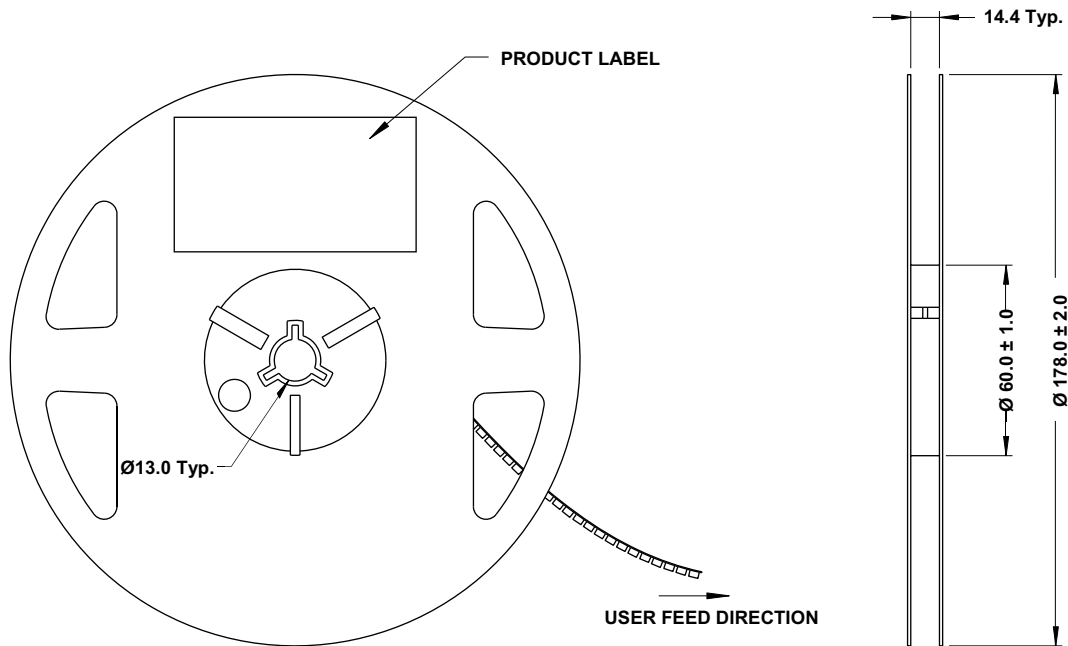

NOTE: All dimensions are in millimeters (mm).

Precautionary Notes

Reflow Soldering

- Do not perform reflow soldering more than twice. Observe necessary precautions of handling moisture-sensitive devices as stated in [Handling of Moisture-Sensitive Devices](#).
- Do not apply any pressure or force on the LED during reflow and after reflow when the LED is still hot.

Figure 16: Recommended Lead-Free Reflow Soldering Profile

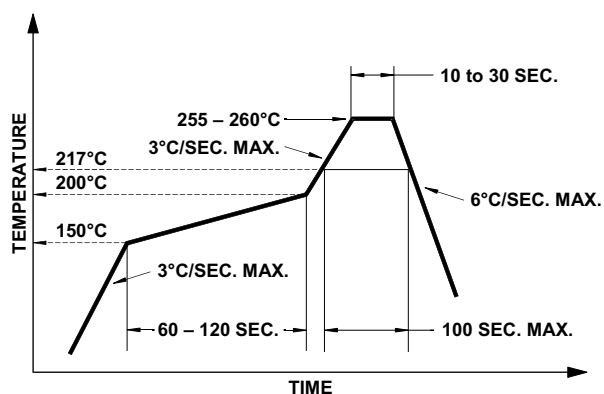

Handling Precautions

The encapsulation material of the LED is made of silicone for better product reliability. Compared to epoxy encapsulant, which is hard and brittle, silicone is softer and flexible. Observe special handling precautions during assembly of silicone encapsulated LED products. Failure to comply might lead to damage and premature failure of the LED. Refer to Broadcom® Application Note AN5288, *Silicone Encapsulation for LED: Advantages and Handling Precautions*, for additional information.

- Do not poke sharp objects into the silicone encapsulant. Sharp objects, such as tweezers or syringes, might apply excessive force or even pierce through the silicone and induce failures to the LED die or wire bond.
- Do not touch the silicone encapsulant. Uncontrolled force acting on the silicone encapsulant might result in excessive stress on the wire bond. Hold the LED only by the body.
- Do not stack assembled PCBs together. Use an appropriate rack to hold the PCBs.
- The surface of silicone material attracts dust and dirt easier than epoxy due to its surface tackiness. To remove foreign particles on the surface of silicone, use a cotton bud with isopropyl alcohol (IPA). During

cleaning, rub the surface gently without putting too much pressure on the silicone. Ultrasonic cleaning is not recommended.

Handling of Moisture-Sensitive Devices

This product has a Moisture Sensitive Level 3 rating per JEDEC J-STD-020. Refer to Broadcom Application Note AN5305, *Handling of Moisture Sensitive Surface Mount Devices*, for additional details and a review of proper handling procedures.

Before use:

- An unopened moisture barrier bag (MBB) can be stored at <40°C/90% RH for 12 months. If the actual shelf life has exceeded 12 months and the humidity indicator card (HIC) indicates that baking is not required, it is safe to reflow the LEDs per the original MSL rating.
- Do not open the MBB prior to assembly (for example, for IQC). If unavoidable, MBB must be properly resealed with fresh desiccant and HIC. The exposed duration must be taken in as floor life.

Control after opening the MBB:

- Read the HIC immediately upon opening of MBB.
- Keep the LEDs at <30°C/60% RH at all times, and complete all high temperature-related processes, including soldering, curing, or rework within 168 hours.

Control for unfinished reel:

Store unused LEDs in a sealed MBB with desiccant or a desiccator at <5% RH.

Control of assembled boards:

If the PCB soldered with the LEDs is to be subjected to other high-temperature processes, store the PCB in a sealed MBB with desiccant or desiccator at <5% RH to ensure that all LEDs have not exceeded their floor life of 168 hours.

Baking is required if the following conditions exist:

- The HIC indicator indicates a change in color for 10% and 5%, as stated on the HIC.
- The LEDs are exposed to conditions of >30°C/60% RH at any time.
- The LED's floor life exceeded 168 hours.

The recommended baking condition is: 60°C ± 5°C for 20 hours. Baking can only be done once.

Storage:

If the LEDs are exposed in an ambient environment for too long, the plating might be oxidized, thus affecting its solderability performance. As such, keep unused LEDs in a sealed MBB with desiccant or in a desiccator at <5% RH.

Application Precautions

- The drive current of the LED must not exceed the maximum allowable limit across temperature as stated in the data sheet. Constant current driving is recommended to ensure consistent performance.
- The circuit design must cater to the whole range of forward voltage (V_F) of the LEDs to ensure the intended drive current can always be achieved.
- The LED exhibits slightly different characteristics at different drive currents, which may result in a larger variation of performance (meaning: intensity, wavelength, and forward voltage). Set the application current as close as possible to the test current to minimize these variations.
- Do not use the LED in the vicinity of material with sulfur content or in environments of high gaseous sulfur compounds and corrosive elements. Examples of material that might contain sulfur are rubber gaskets, room-temperature vulcanizing (RTV) silicone rubber, rubber gloves, and so on. Prolonged exposure to such environments may affect the optical characteristics and product life.
- Avoid a rapid change in ambient temperature, especially in high-humidity environments, because it causes condensation on the LED.
- If the LED is intended to be used in harsh or outdoor environment, protect the LED against damages caused by rain water, water, dust, oil, corrosive gases, external mechanical stresses, and so on.

Thermal Management

The optical, electrical, and reliability characteristics of the LED are affected by temperature. Keep the junction temperature (T_J) of the LED below the allowable limit at all times. T_J can be calculated as follows:

$$T_J = T_A + R_{\theta J-A} \times I_F \times V_{Fmax}$$

where:

T_A = ambient temperature ($^{\circ}\text{C}$)

$R_{\theta J-A}$ = thermal resistance from LED junction to ambient ($^{\circ}\text{C}/\text{W}$)

I_F = forward current (A)

V_{Fmax} = maximum forward voltage (V)

The complication of using this formula lies in T_A and $R_{\theta J-A}$. Actual T_A is sometimes subjective and hard to determine. $R_{\theta J-A}$ varies from system to system depending on design and is usually not known.

Another way of calculating T_J is by using the solder point temperature, T_S as follows:

$$T_J = T_S + R_{\theta J-S} \times I_F \times V_{Fmax}$$

where:

T_S = LED solder point temperature as shown in [Figure 17](#) ($^{\circ}\text{C}$)

$R_{\theta J-S}$ = thermal resistance from junction to solder point ($^{\circ}\text{C}/\text{W}$)

I_F = forward current (A)

V_{Fmax} = maximum forward voltage (V)

Figure 17: Solder Point Temperature on PCB

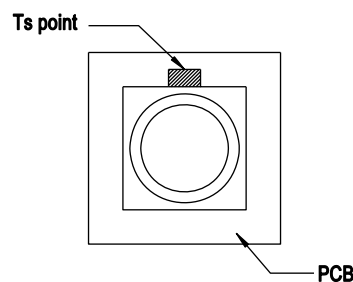

T_S can be easily measured by mounting a thermocouple on the soldering joint as shown in [Figure 17](#), while $R_{\theta J-S}$ is provided in the data sheet. Verify the T_S of the LED in the final product to ensure that the LEDs are operating within all maximum ratings stated in the data sheet.

Eye Safety Precautions

LEDs may pose optical hazards when in operation. Do not look directly at operating LEDs because it might be harmful to the eyes. For safety reasons, use appropriate shielding or personal protective equipment.

Disclaimer

Broadcom's products and software are not specifically designed, manufactured, or authorized for sale as parts, components, or assemblies for the planning, construction, maintenance, or direct operation of a nuclear facility or for use in medical devices or applications. The customer is solely responsible, and waives all rights to make claims against Broadcom or its suppliers, for all loss, damage, expense, or liability in connection with such use.

Broadcom, the pulse logo, Connecting everything, Avago Technologies, Avago, and the A logo are among the trademarks of Broadcom and/or its affiliates in the United States, certain other countries, and/or the EU.

Copyright © 2018 Broadcom. All Rights Reserved.

The term "Broadcom" refers to Broadcom Inc. and/or its subsidiaries. For more information, please visit www.broadcom.com.

Broadcom reserves the right to make changes without further notice to any products or data herein to improve reliability, function, or design. Information furnished by Broadcom is believed to be accurate and reliable. However, Broadcom does not assume any liability arising out of the application or use of this information, nor the application or use of any product or circuit described herein, neither does it convey any license under its patent rights nor the rights of others.

