

TOSHIBA BIPOLAR DIGITAL INTEGRATED CIRCUIT SILICON MONOLITHIC

TD62703P, TD62703F

6CH HIGH VOLTAGE SOURCE DRIVER

The TD62703P, TD62703F is comprised of six source current Transistor Array.
 These drivers are specifically designed for fluorescent display applications.
 For proper operation, the substrate (SUB) must be connected to the most negative voltage.

FEATURES

- High output voltage : V_{CC} , $V_{OUT} = 60V$ (Min.)
- Output current (single output) : $I_{OUT} = -50mA$ (Max.)
- Input resistor : $R_{IN} = 2.7k\Omega$
- Package type-P : DIP-14 pin
- Package type-F : SOP-14 pin

PIN CONNECTION (TOP VIEW)

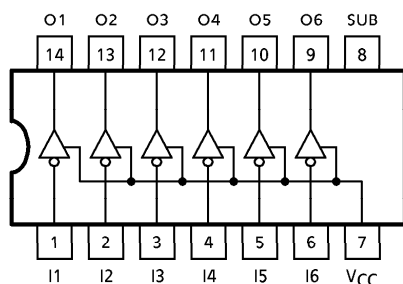

SCHEMATICS (EACH DRIVER)

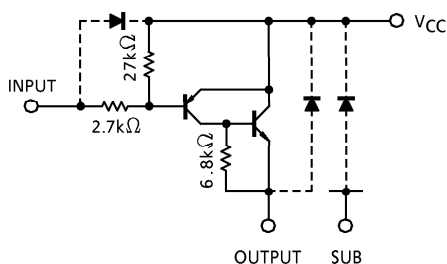

(Note) The input and output parasitic diodes cannot be used as clamp diodes.

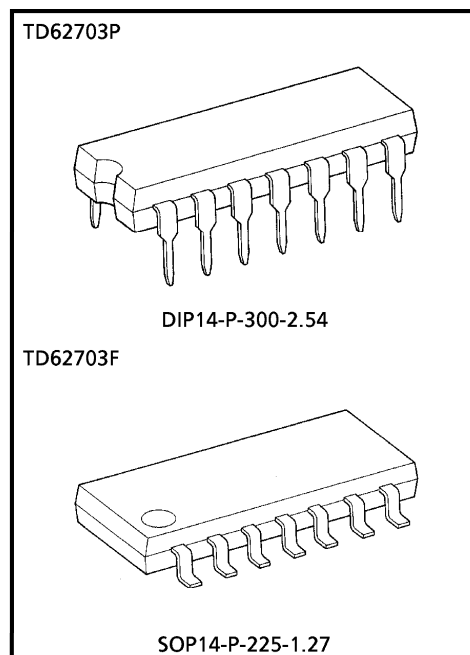

Weight
 DIP14-P-300-2.54 : 1.11g (Typ.)
 SOP14-P-225-1.27 : 0.16g (Typ.)

961001EBA2

- TOSHIBA is continually working to improve the quality and the reliability of its products. Nevertheless, semiconductor devices in general can malfunction or fail due to their inherent electrical sensitivity and vulnerability to physical stress. It is the responsibility of the buyer, when utilizing TOSHIBA products, to observe standards of safety, and to avoid situations in which a malfunction or failure of a TOSHIBA product could cause loss of human life, bodily injury or damage to property. In developing your designs, please ensure that TOSHIBA products are used within specified operating ranges as set forth in the most recent products specifications. Also, please keep in mind the precautions and conditions set forth in the TOSHIBA Semiconductor Reliability Handbook.
- The products described in this document are subject to foreign exchange and foreign trade control laws.
- The information contained herein is presented only as a guide for the applications of our products. No responsibility is assumed by TOSHIBA CORPORATION for any infringements of intellectual property or other rights of the third parties which may result from its use. No license is granted by implication or otherwise under any intellectual property or other rights of TOSHIBA CORPORATION or others.
- The information contained herein is subject to change without notice.

MAXIMUM RATINGS (Ta = 25°C)

CHARACTERISTIC	SYMBOL	RATING	UNIT
Supply Voltage	V _{SUB}	V _{CC} - 60	V
Output Sustaining Voltage	V _{OUT}	V _{CC} - 60	V
Input Voltage	V _{IN}	- 30~0.5	V
Output Current	I _{OUT}	- 50	mA / ch
Input Current	I _{IN}	10	mA
Power Dissipation	P	1.0	W
	F	0.625 (Note 1)	
Operating Temperature	T _{opr}	- 40~85	°C
Storage Temperature	T _{stg}	- 55~150	°C

(Note 1) On Glass Epoxy PCB (50×50×1.6mm Cu 50%)

(Note 2) Delated above 25°C in the proportion 8.0mW/°C (P Type), 5.0mW/°C (F Type).

RECOMMENDED OPERATING CONDITIONS (Ta = - 40~85°C)

CHARACTERISTIC	SYMBOL	CONDITION	MIN.	TYP.	MAX.	UNIT
Supply Voltage	V _{SUB}	V _{CC} = 0V	V _{OUT}	—	- 55	V
Output Sustaining Voltage	V _{OUT}		0	—	V _{SUB}	V
Output Current	I _{OUT}		0	—	- 40	mA / ch
Input Voltage	V _{IN}		0	—	- 7.0	V
Power Dissipation	P	—	—	—	0.36	W
	F	On PCB (Note)	—	—	0.325	

(Note) On Glass Epoxy PCB (50×50×1.6mm Cu 30%)

ELECTRICAL CHARACTERISTICS (Ta = 25°C)

CHARACTERISTIC	SYMBOL	TEST CIR-CUIT	TEST CONDITION	MIN.	TYP.	MAX.	UNIT
Output Leakage Current	I _{CEX}	1	V _{CC} = 0V, V _{IN} = 0V V _{OUT} = - 55V	—	—	- 100	μA
Collector-Emitter Saturation Voltage	V _{CE} (sat)	2	I _{IN} = - 1mA, I _{OUT} = - 40mA	—	—	- 2.5	V
DC Current Transfer Ratio	h _{FE}	2	V _{CE} = - 5.0V, I _{OUT} = - 40mA	100	—	—	—
Input Current	Output On	3	V _{CC} = 0V, V _{IN} = - 5.1V	—	- 1.7	- 2.4	mA
	Output Off			—	—	10	μA
Input Voltage	Output On	4	V _{CC} = 0V	- 3.0	—	—	V
	Output Off			—	—	- 0.44	
Turn-On Delay	P	5	V _{CC} = 0V, V _{SUB} = V _{OUT} = - 55V R _L = 1.4kΩ, C _L = 15pF	—	1	—	μs
	F			—	0.5	—	
Turn-Off Delay	P	5	V _{CC} = 0V, V _{SUB} = V _{OUT} = - 55V R _L = 1.4kΩ, C _L = 15pF	—	2	—	μs
	F			—	1	—	

TEST CIRCUIT

1. I_{CEX}

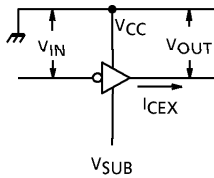

2. $V_{CE(sat)}$, h_{FE}

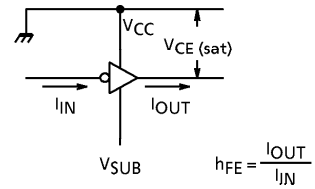

3. $I_{IN(ON)}$, $I_{IN(OFF)}$

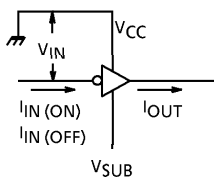

4. $V_{IN(ON)}$, $V_{IN(OFF)}$

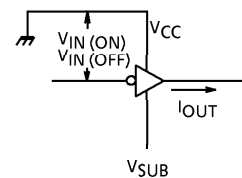

5. t_{ON} , t_{OFF}

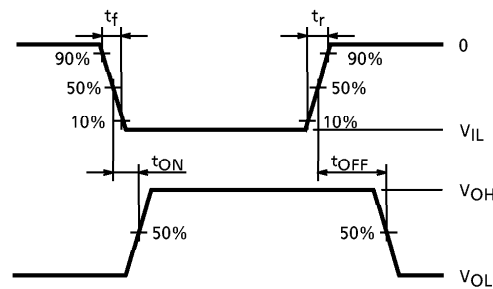
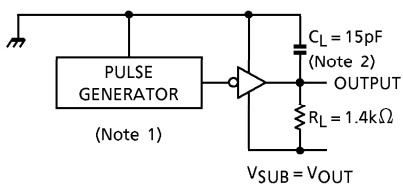

- (Note 1) Pulse Width $50\mu s$, Duty Cycle 10%
Output Impedance 50Ω , $t_r \leq 10ns$, $t_f \leq 5ns$
- (Note 2) C_L includes probe and jig capacitance.

PRECAUTIONS for USING

Utmost care is necessary in the design of the output line, V_{CC} and GND (SUB) line since IC may be destroyed due to short-circuit between outputs, air contamination fault, or fault by improper grounding.

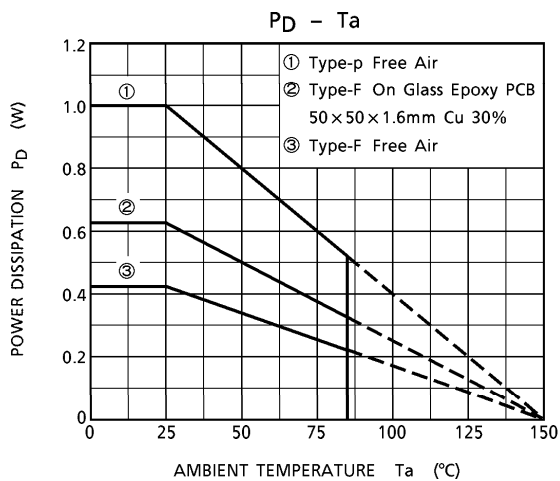
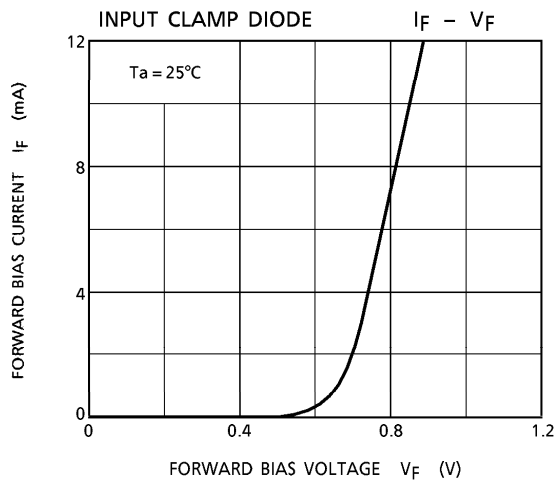
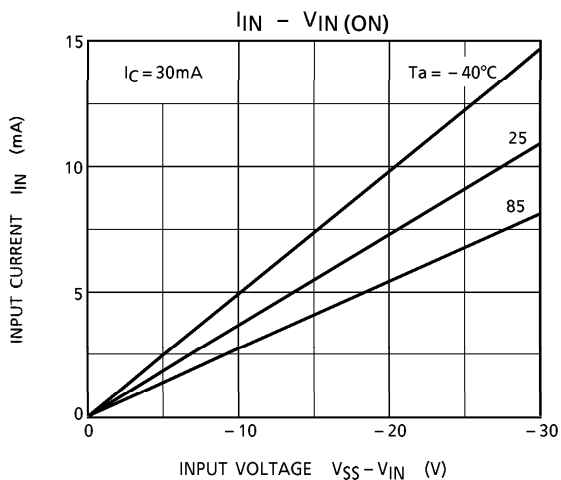

OUTLINE DRAWING
SOP14-P-225-1.27

Unit : mm

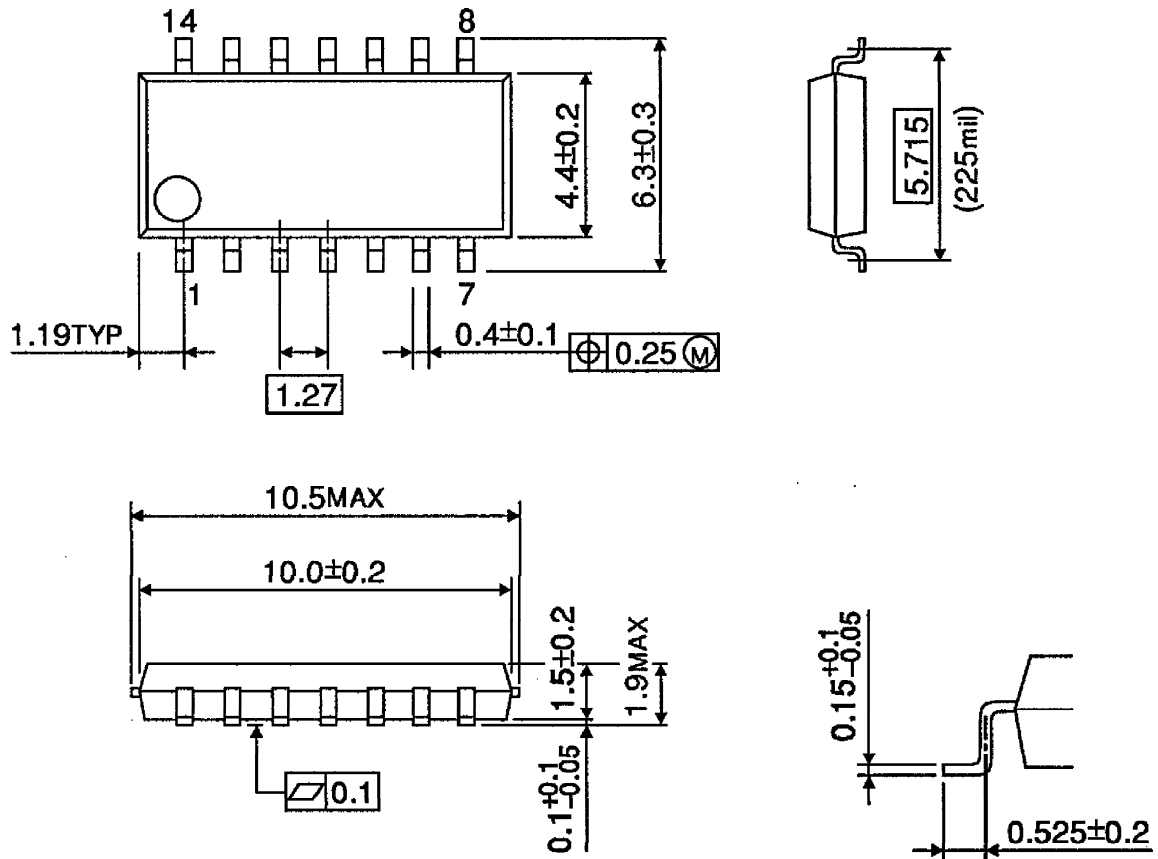

Weight : 0.16g (Typ.)