



Spec. No.	PS-DS-S56124/S56125S
Rev.	A

# PRODUCT SPECIFICATION

**Model No:CSS-S56124S/S56125S**

## Descriptions:

- 0.56 Inch Single Digit SMD Display
- Emitting Color : Super Bright Red



CUSTOMER APPROVED SIGNATURES	APPROVED BY	CHECKED BY	PREPARED BY

**CHINA SEMICONDUCTOR CORPORATION**  
Address:2FL. NO.909,Chung-Cheng Road,  
Chung-Ho City Taipei Hsien,Taiwan.

Tel:886-2-2223-9696  
Fax:886-2-2223-9377

**OPTO PLUS TECHNOLOGIES CO.,LTD**  
Address:696 Shun jiang Rd.,Ji Shan St.Shaoxing,  
ZheJiang,China

Tel:86-0575-88623888  
Fax:86-0575-88623112



**Model No : CSS-S56124/S56125S**

**Features -**

1. 0.56 inch (14.2mm) digit height.
2. Qualified according to JEDEC moisture sensitivity Level 2a.
3. RoHS compliant.
4. Low power consumption.
5. Easy mounting on P.C. board.

**Device Selection Guide -**

Model No.	Chip		Description
	Material	Emitting Color	
CSS-S56124S	AlGaAs	Super Bright Red	Common Anode
CSS-S56125S	AlGaAs	Super Bright Red	Common Cathode

**Mechanical Dimensions -**

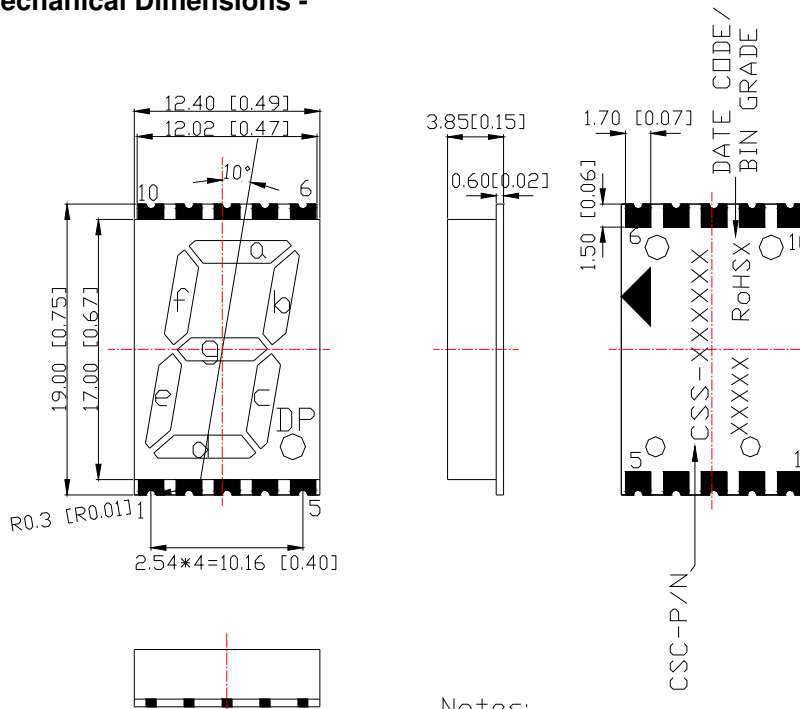

**Notes:**

All dimensions are in millimeters [inches], and tolerance is  $\pm 0.25$  [0.010] unless otherwise noted.



Model No : CSS-S56124/S56125S

Internal Circuit Diagrams -

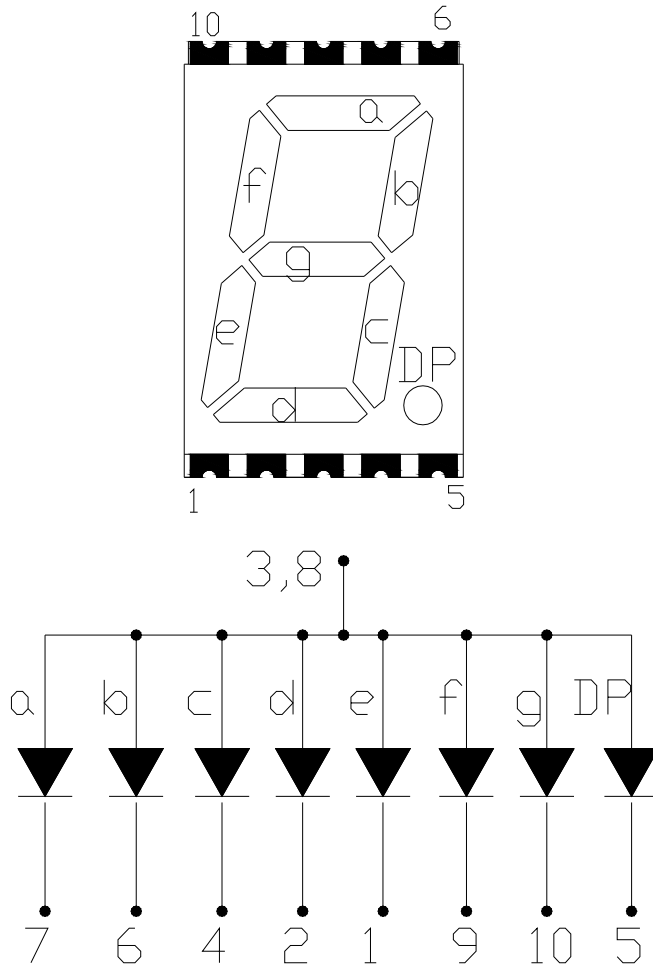

CSS-S56124 Common Anode  
(CSS-S56125 Common Cathode)



Model No : CSS-S56124/S56125S

■ Absolute Maximum Rating -

(Ta=25°C)

Parameter	Symbol	Rating	Unit
Power Dissipation Per Dice	P <sub>AD</sub>	75	mW
Continuous Forward Current Per Dice	I <sub>AF</sub>	30	mA
Peak Current Per Dice(duty cycle 1/10,1KHz)	I <sub>PF</sub>	120	mA
Derating Linear From 25°C Per Dice	-	0.42	mA/°C
Reverse Voltage Per Dice	V <sub>R</sub>	5	V
Operating Temp.	T <sub>opr</sub>	-40 ~ +105	°C
Storage Temp.	T <sub>stg</sub>	-40 ~ +105	°C

Note:Solder temperature 1/16 inch below seating plane for 3 seconds at 260°C

■ Electro-optical Characteristics -

(Ta=25°C)

Parameter	Symbol	Min.	Typ.	Max.	Unit	Condition
Forward Voltage Per Segment	V <sub>F</sub>	-	1.8	2.5	V	I <sub>F</sub> =20mA
Luminous Intensity Per Segment	I <sub>v</sub>	3	8	-	mcd	I <sub>F</sub> =10mA
Peak Emission Wavelength	λ <sub>P</sub>	-	660	-	nm	I <sub>F</sub> =20mA
Spectrum Radiation Bandwidth	Δλ	-	20	-	nm	I <sub>F</sub> =20mA
Reverse Current	I <sub>R</sub>	-	-	100	μA	V <sub>R</sub> =5V
Luminous Intensity Matching Ratio	I <sub>V-m</sub>	-	-	2:1	-	I <sub>F</sub> =10mA



**Model No : CSS-S56124/S56125S**

**Typical Electrical / Optical Characteristics Curves -**

(Ta = 25°C Unless Otherwise Noted)

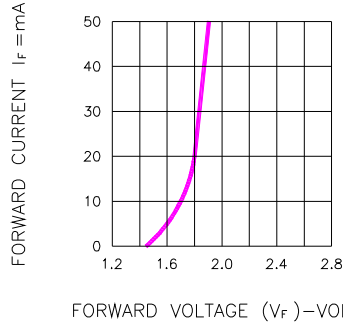

Fig.1 FORWARD CURRENT VS. FORWARD VOLTAGE

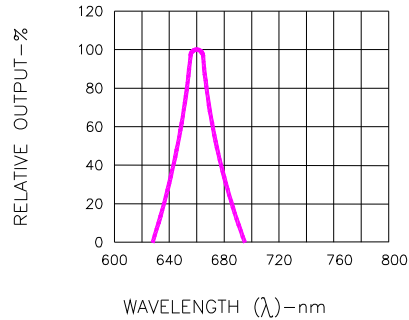

Fig.2 SPECTRAL RESPONSE

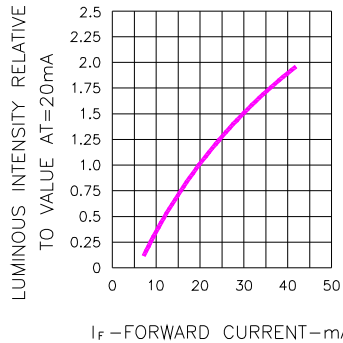

Fig.3 RELATIVE LUMINOUS INTENSITY VS. FORWARD CURRENT

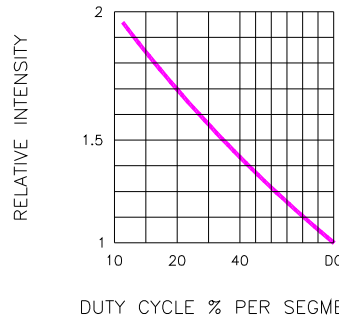

Fig.5 LUMINOUS INTENSITY VS. DUTY CYCLE

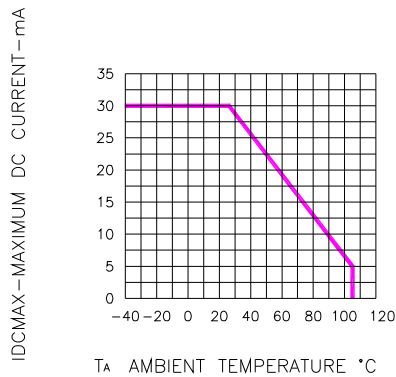

Fig.4 MAXIMUM ALLOWABLE DC CURRENT PER SEGMENT VS. A FUNCTION OF AMBIENT TEMPERATURE

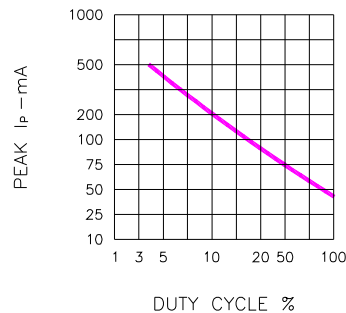

Fig.6 MAX PEAK CURRENT VS. DUTY CYCLE % (REFRESH RATE f=1 KHz)



Model No : CSS-S56124/S56125S

## SMT REFLOW SOLDERING INSTRUCTIONS

### ■ IR Reflow Temperature / Time :

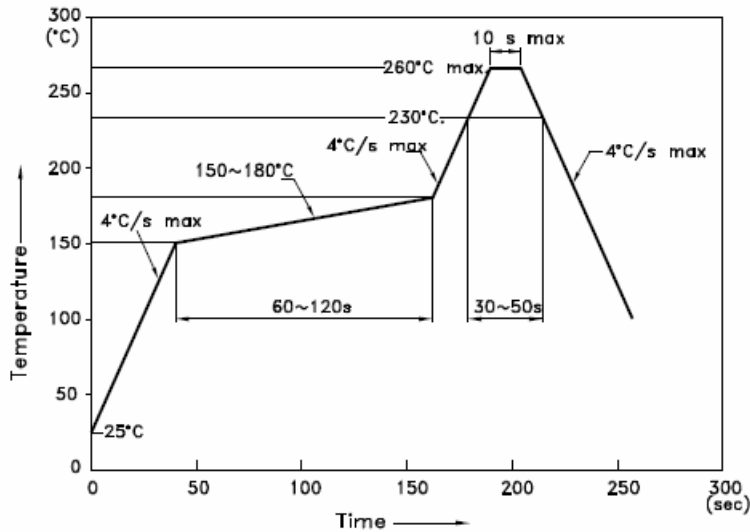

#### NOTES:

1. We recommend the reflow temperature 245°C(+/-5°C). The maximum soldering temperature should be limited to 260°C.
2. Don't cause stress to the epoxy resin while it is exposed to high temperature.
3. Number of reflow process shall be 2 times or less.

### ■ Soldering Pad Size

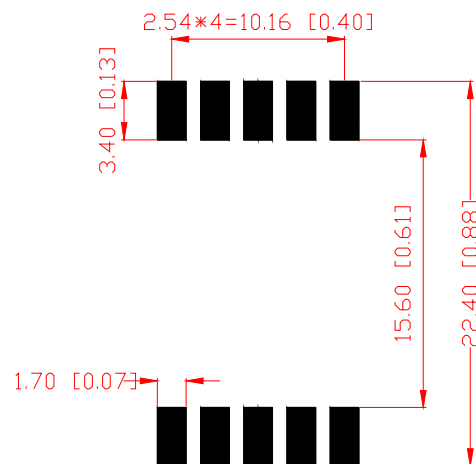



Model No : CSS-S56124/S56125S

### REEL DIMENSIONS

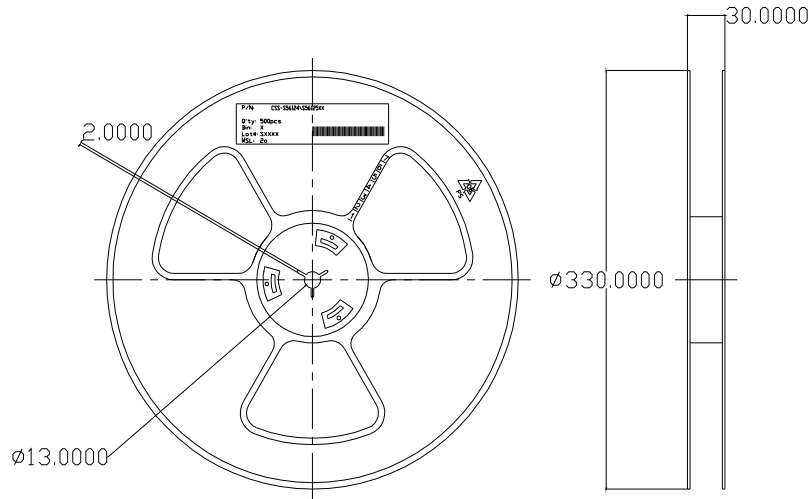

### PACKING & LABEL SPECIFICATIONS

