

Specify AEL

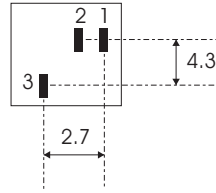

Ceramic Filter LTU Series 455kHz or 450kHz

Ceramic Filters

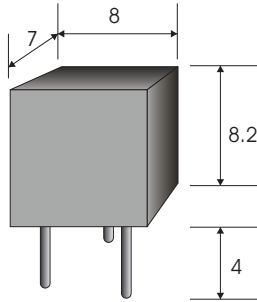

Pin Connections

- 1 = Input
- 2 = Ground
- 3 = Output

To take the best advantage of the safety feature of ceramic filters, connect output to an IF amplifier through a DC cut capacitor. Avoid directly applying DC to output end of ceramic filters (Between 5 & 2,3,4)

FEATURES

- High Selectivity
- Low Cost
- Wide Range of bandwidths Available
- Industry Standard Outline & Pinout

APPLICATIONS

- Communications Equipment

SPECIFICATION

Part Number	Centre Freq (MHz)	Insertion Loss (dB Max)	Pass Band Ripple (dB Max)	6 dB Bandwidth (kHz Min)	40 dB Bandwidth (kHz Min)	Stopband Att. +/-100kHz (dB Min)	Input/Output Impedance ()
LTU455B2	455 +/-2.0	4	2	+/-15.0	+/-30.0	27	1500
LTU455C2	455 +/-2.0	4	2	+/-12.5	+/-24.0	27	1500
LTU455D2	455 +/-1.5	4	2	+/-10.0	+/-20.0	27	1500
LTU455E2	455 +/-1.5	6	2	+/-7.5	+/-15.0	27	1500
LTU455F2	455 +/-1.5	6	2	+/-6.0	+/-12.5	27	2000
LTU455G2	455 +/-1.5	6	2	+/-4.5	+/-10.0	25	2000
LTU455H2	455 +/-1.0	6	2	+/-3.0	+/-9.0	25	2000
LTU455I2	455 +/-1.0	6	2	+/-2.0	+/-7.5	25	2000
LTU455HT	455 +/-1.0	6	2	+/-3.0	+/-9.0	35	2000

Frequency Characteristics

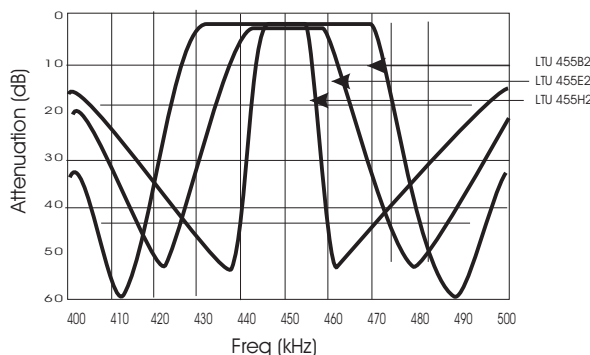

Test Circuit

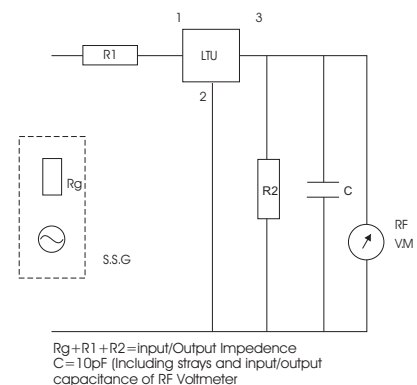

www.aelcrystals.co.uk

quartz based frequency control components

Order Hotline +44 1293 524245

www.aelcrystals.co.uk
sales@aelcrystals.co.uk

Specify AEL

Ceramic Filter LTW33 Series 450 kHz & 455kHz



Ceramic Filters

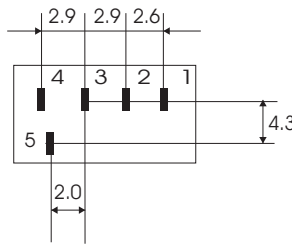
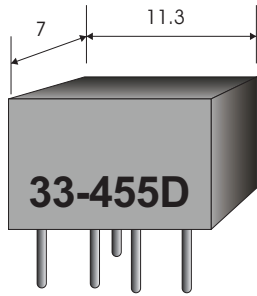

Pin Connections

- 1 = Input
- 2 = Ground
- 3 = Ground
- 4 = Ground
- 5 = Output

To take the best advantage of the safety feature of ceramic filters, connect output to anIF amplifier through a DC cut capacitor. Avoid directly applying DC to output end of ceramic filters (Between 5 & 2,3,4)

FEATURES

- High Selectivity
- Low Cost
- Wide Range of bandwidths Available
- Industry Standard Outline

APPLICATIONS

- Communications Equipment

SPECIFICATION

Part Number	Centre Freq (MHz)	Insertion Loss (dB Max)	Pass Band Ripple (dB Max)	6 dB Bandwidth (kHz Min)	40 dB Bandwidth (kHz Min)	Stopband Att. +/- 100kHz (dB Min)	Input/Output Impedance ()
LTW33-455B	455 +/- -2.0	4	2	+/- 15.0	+/- 30.0	35	1500
LTW33-455C	455 +/- -2.0	4	2	+/- 12.5	+/- 24.0	35	1500
LTW33-455D	455 +/- -1.5	4	2	+/- 10.0	+/- 20.0	35	1500
LTW33-455E	455 +/- -1.5	6	2	+/- 7.5	+/- 15.0	35	1500
LTW33-455F	455 +/- -1.5	6	2	+/- 6.0	+/- 12.5	35	2000
LTW33-455G	455 +/- -1.5	6	2	+/- 4.5	+/- 10.0	35	2000
LTW33-455H	455 +/- -1.0	6	2	+/- 3.0	+/- 9.0	35	2000
LTW33-455I	455 +/- -1.0	6	2	+/- 2.0	+/- 7.5	35	2000
LTW33-455HT	455 +/- -1.0	6	2	+/- 3.0	+/- 9.0	60	2000

Frequency Characteristics

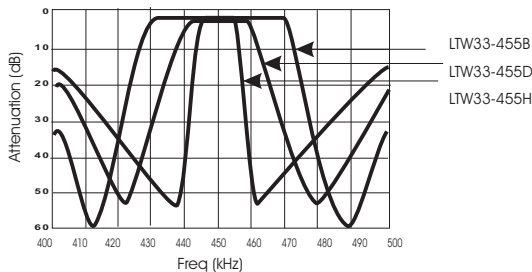

Test Circuit

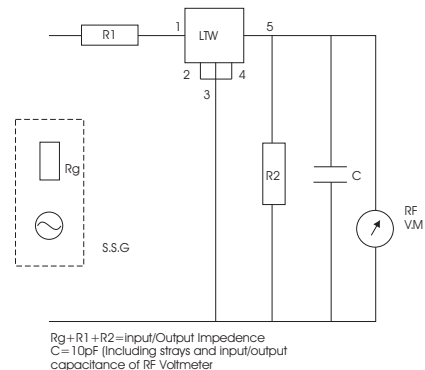

www.aelcrystals.co.uk

quartz based frequency control components

Order Hotline +44 1293 524245

www.aelcrystals.co.uk
sales@aelcrystals.co.uk