

TO-126 Plastic-Encapsulate Transistors

BD434 / BD436 / BD438 TRANSISTOR (PNP)

FEATURES

- Amplifier and Switching Applications
- Complement To BD433, BD435 And BD437

MARKING

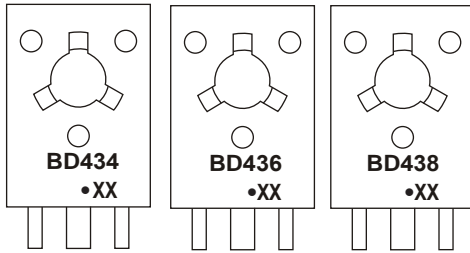

BD434, BD436, BD438 = Device code
 Solid dot = Green molding compound device, if none, the normal device
 XX = Code

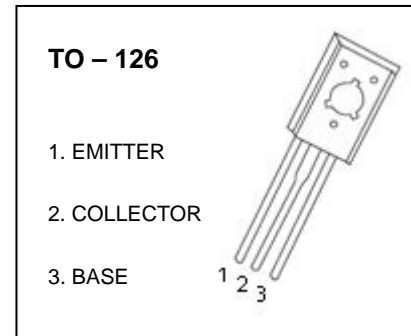

Equivalent Circuit

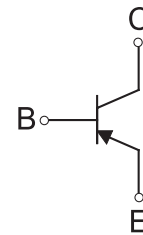

ORDERING INFORMATION

Part Number	Package	Packing Method	Pack Quantity
BD434	TO-126	Bulk	200pcs/Bag
BD436	TO-126	Bulk	200pcs/Bag
BD438	TO-126	Bulk	200pcs/Bag
BD434-TU	TO-126	Tube	60pcs/Tube
BD436-TU	TO-126	Tube	60pcs/Tube
BD438-TU	TO-126	Tube	60pcs/Tube

MAXIMUM RATINGS (T_a=25°C unless otherwise noted)

Symbol	Parameter	Value	Unit
V _{CBO}	Collector-Base Voltage	BD434	-22
		BD436	-32
		BD438	-45
V _{CEO}	Collector-Emitter Voltage	BD434	-22
		BD436	-32
		BD438	-45
V _{EBO}	Emitter-Base Voltage	-5	V
I _C	Collector Current –Continuous	-4	A
P _C	Collector Power Dissipation	1.25	W
T _J , T _{stg}	Junction Temperature	-55-150	°C

ELECTRICAL CHARACTERISTICS

$T_a=25\text{ }^\circ\text{C}$ unless otherwise specified

Parameter	Symbol	Test conditions	Min	Typ	Max	Unit
Collector-base breakdown voltage	$V_{(BR)CBO}$	$I_C=-100\mu\text{A}, I_E=0$	BD434 -22 BD436 -32 BD438 -45			V
Collector-emitter breakdown voltage	$V_{CE(SUS)}^{(1)}$	$I_C=-100\text{mA}, I_B=0$	BD434 -22 BD436 -32 BD438 -45			V
Emitter-base breakdown voltage	$V_{(BR)EBO}$	$I_E=-100\mu\text{A}, I_C=0$	-5			V
Collector cut-off current	I_{CBO}	$V_{CB}=-22\text{V}, I_E=0$ $V_{CB}=-32\text{V}, I_E=0$ $V_{CB}=-45\text{V}, I_E=0$	BD434 BD436 BD438		-100	μA
Emitter cut-off current	I_{EBO}	$V_{EB}=-5\text{V}, I_E=0$			-1	mA
DC current gain	$h_{FE(1)}^{(1)}$	$V_{CE}=-1\text{V}, I_C=-500\text{mA}$	85		375	
	$h_{FE(2)}^{(1)}$	$V_{CE}=-5\text{V}, I_C=-10\text{mA}$	BD434/BD436 40 BD438 30			
	$h_{FE(3)}^{(1)}$	$V_{CE}=-1\text{V}, I_C=-2\text{A}$	BD434/BD436 50 BD438 40			
Collector-emitter saturation voltage	$V_{CE(sat)}^{(1)}$	$I_C=-2\text{A}, I_B=-0.2\text{A}$	BD434/BD436		-0.5	V
		$I_C=-3\text{A}, I_B=-0.3\text{A}$	BD438		-0.7	
Base-emitter voltage	$V_{BE}^{(1)}$	$V_{CE}=-1\text{V}, I_C=-2\text{A}$	BD434/BD436 BD438		-1.1 -1.2	V
Transition frequency	f_T	$V_{CE}=-1\text{V}, I_C=-250\text{mA}$	3			MHz

⁽¹⁾Pulse test.

Typical Characteristics

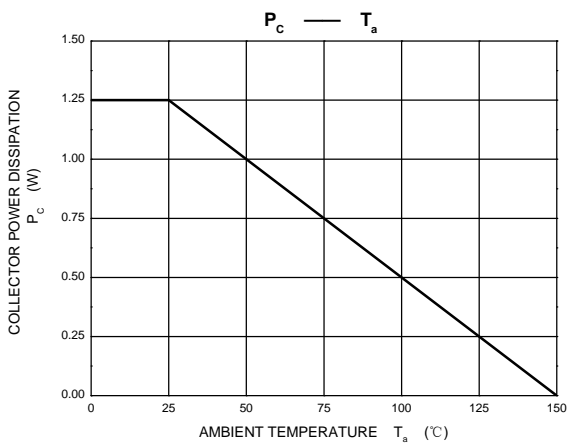
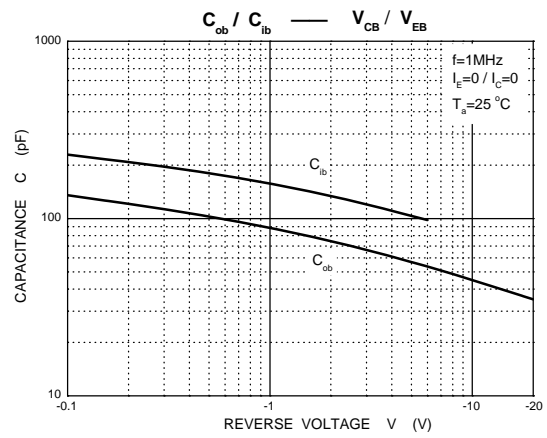
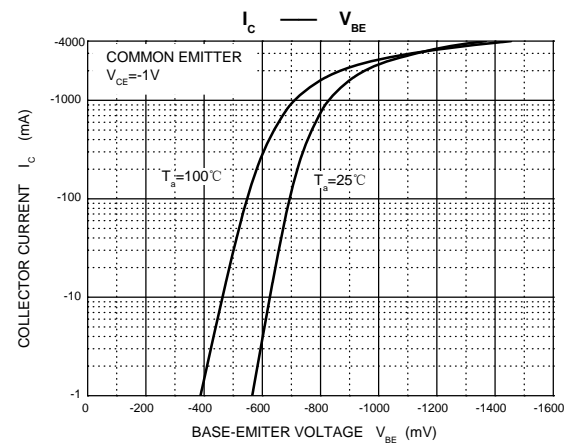
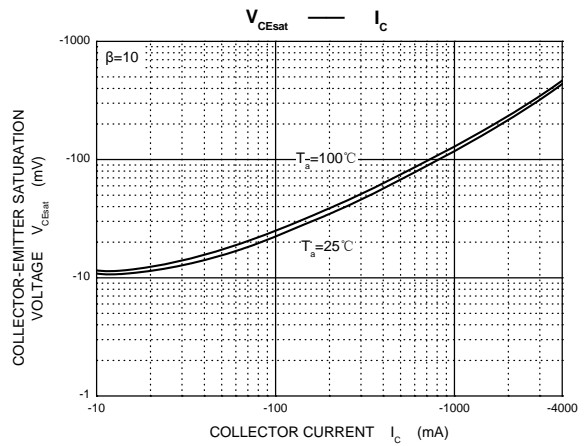
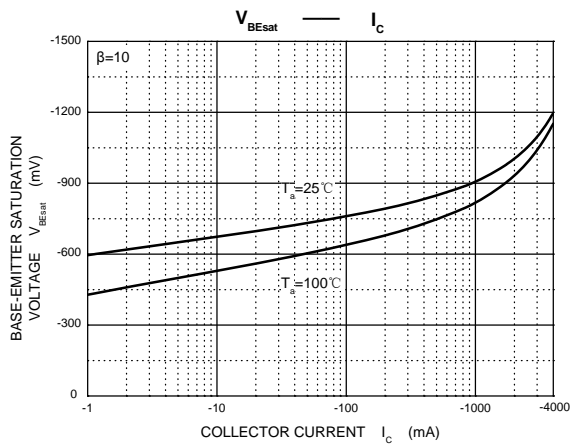
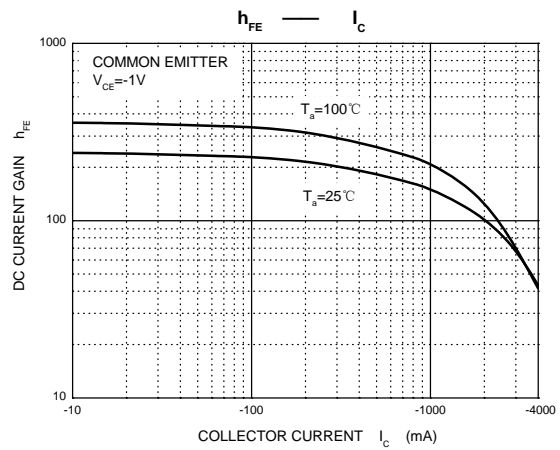
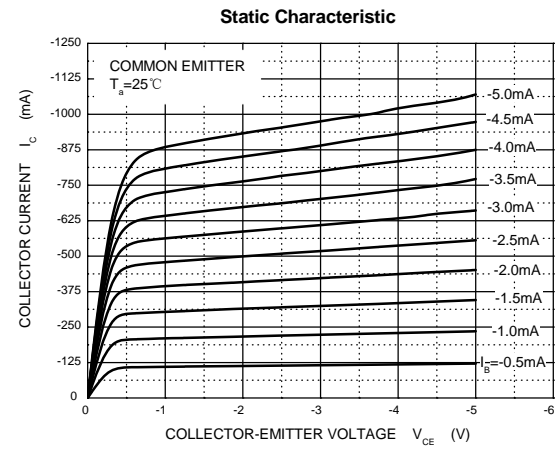

TO-126 Package Outline Dimensions

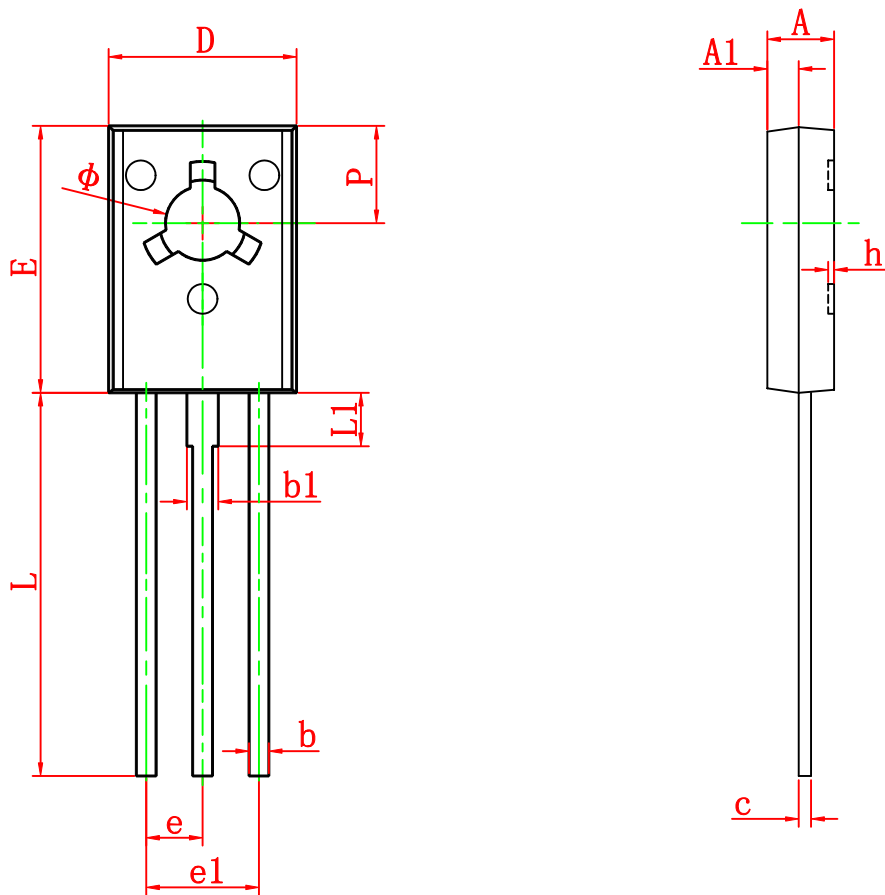

Symbol	Dimensions In Millimeters		Dimensions In Inches	
	Min	Max	Min	Max
A	2.500	2.900	0.098	0.114
A1	1.100	1.500	0.043	0.059
b	0.660	0.860	0.026	0.034
b1	1.170	1.370	0.046	0.054
c	0.450	0.600	0.018	0.024
D	7.400	7.800	0.291	0.307
E	10.600	11.000	0.417	0.433
e	2.290 TYP		0.090 TYP	
e1	4.480	4.680	0.176	0.184
h	0.000	0.300	0.000	0.012
L	15.300	15.700	0.602	0.618
L1	2.100	2.300	0.083	0.091
P	3.900	4.100	0.154	0.161
Φ	3.000	3.200	0.118	0.126