



Technical Data Sheet

Opto Interrupter ITR

ITR8307/L24/F43

■ Features

- Fast response time
- High sensitivity
- Cut-Off visible wavelength
- Thin
- Compact
- Pb free

■ Descriptions

ITR8307/L24/F43 is a light reflection switch which includes a GaAs IR-LED transmitter and a NPN photo-darlington with a high photosensitive receiver for short distance, operating in the infrared range. Both components are mounted side- by- side in a plastic package.

■ Applications

- Camera
- VCR
- Floppy disk driver
- Cassette type recorder
- Various microcomputer control equipment

■ Device Selection Guide

Device No.	Chip Material
IR	GaAs
PT	Silicon

Package Dimensions

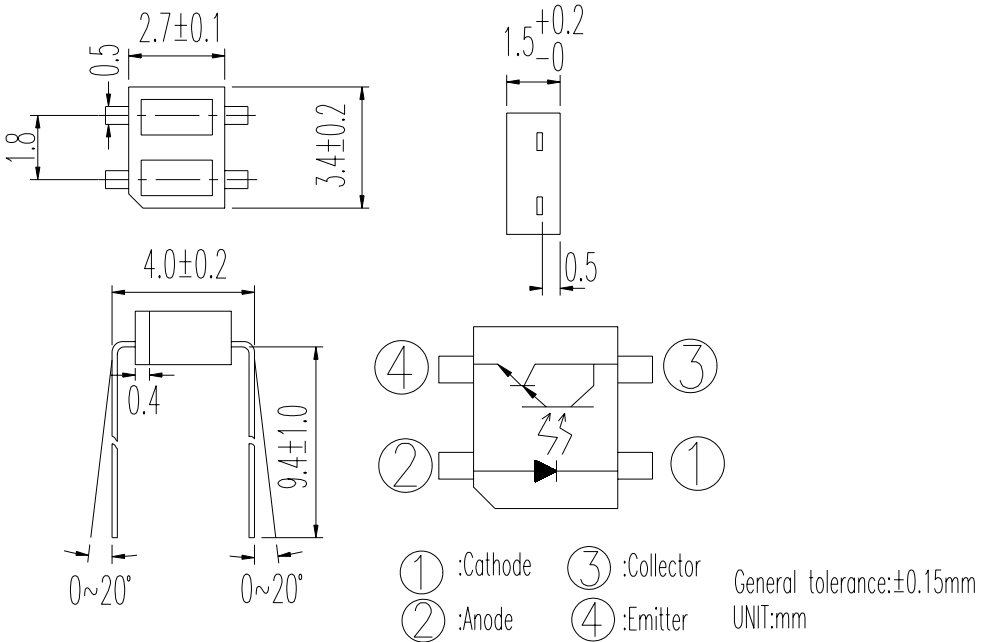

- Notes:** 1.All dimensions are in millimeters
 2.Tolerances unless dimensions ±0.25mm

Absolute Maximum Ratings (Ta=25°C)

Parameter		Symbol	Ratings	Unit
Input	Power Dissipation at(or below) 25°C Free Air Temperature	Pd	75	mW
	Reverse Voltage	V _R	6	V
	Forward Current	I _F	50	mA
	Peak Forward Current (*1) Pulse width ≤ 100 μs, Duty cycle=1%	I _{FP}	1	A
Output	Collector Power Dissipation	P _C	100	mW
	Collector Current	I _C	20	mA
	Collector-Emitter Voltage	B V _{CEO}	35	V
	Emitter-Collector Voltage	B V _{ECO}	6	V
Operating Temperature		T _{opr}	-25~+85	-20~+70
Storage Temperature		T _{stg}	-30~+90	-30~+80
Lead Soldering Temperature (*2)		T _{sol}	260	260

(*1) tw=100 μsec., T=10 msec. (*2) t=5 Sec

Electro-Optical Characteristics (Ta=25°C)

Parameter		Symbol	Min.	Typ.	Max.	Unit	Conditions
Input	Forward Voltage	VF	-	1.2	1.4	V	IF=20mA
	Reverse Current	IR	-	-	10	μA	VR=6V
	Peak Wavelength	λP	-	940	-	nm	-
Output	Dark Current	ICEO	-	-	1	μA	VCE=10V, Ee=1mW/cm2
Transfer Characteristics	Collector Current	IC(ON)	0.5	3.0	15.0	mA	VCE=2V, IF=4mA
	Leakage Current	ILEAK	-	-	5	μA	VCE=2V, IF=4mA
	Rise time	tr	-	80	400	μs	VCE=2V IC=10mA
	Fall time	tf	-	70	400	μs	RL=100Ω, d=1mm

Rank

Conditions : IF=4mA VCE=2V

Unit: mA

Bin number	Min	Max
B	0.50	1.10
C	0.90	1.90
D	1.45	3.20
E	2.45	5.40
F	4.05	8.90
G	6.30	15.0

Typical Electrical/Optical/Characteristics Curves for IR

Fig. 1 Forward Current vs. Ambient Temperature

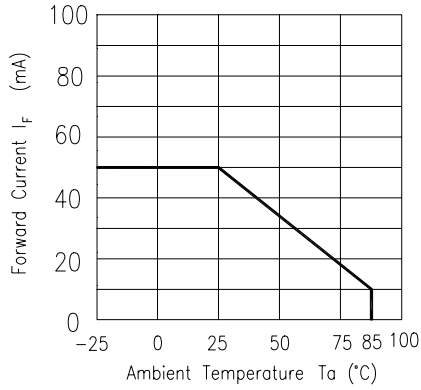

Fig. 2 Spectral Distribution

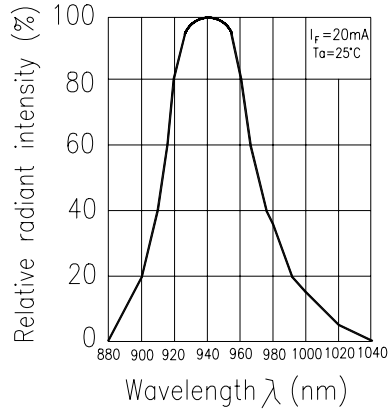

Fig. 3 Peak Emission Wavelength vs. Ambient Temperature

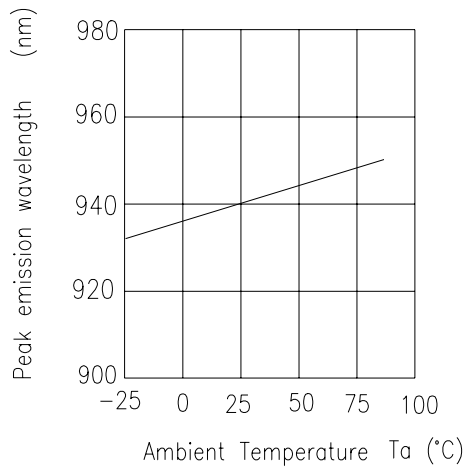

Fig. 4 Forward Current vs. Forward Voltage

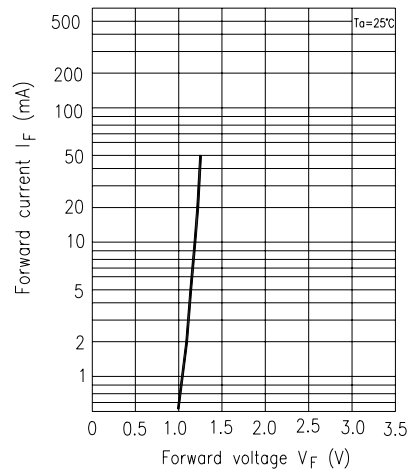

Fig. 5 Forward Voltage vs. Ambient Temperature

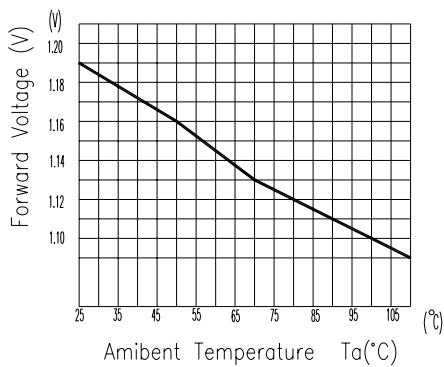
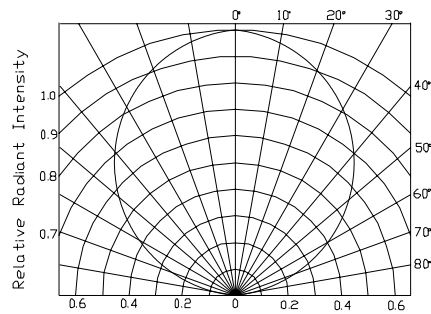

Fig. 6 Relative Radiant Intensity vs. Angular Displacement



Typical Electrical/Optical/Characteristics Curves for PT

Fig.1 Collector Power Dissipation vs. Ambient Temperature

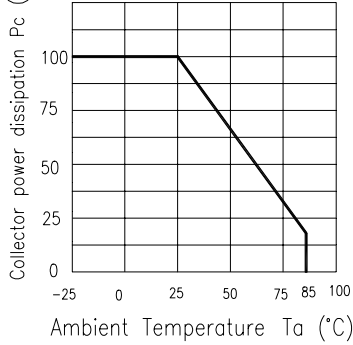

Fig.2 Collector Dark Current vs. Ambient Temperature

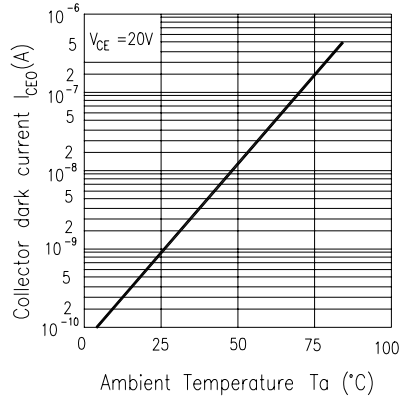

Fig. 3 Relative Collector Current vs. Ambient Temperature

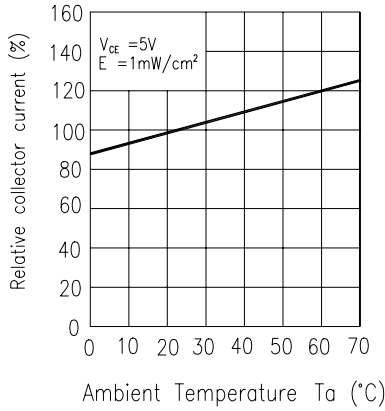

Fig.4 Collector Current vs. Irradiance

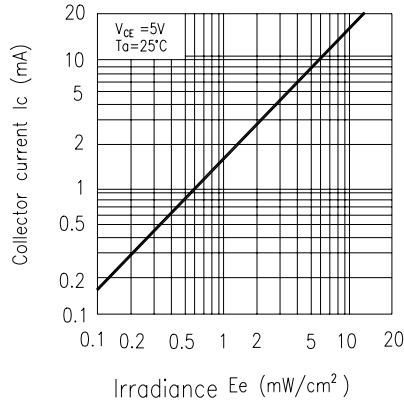

Fig.5 Spectral Sensitivity

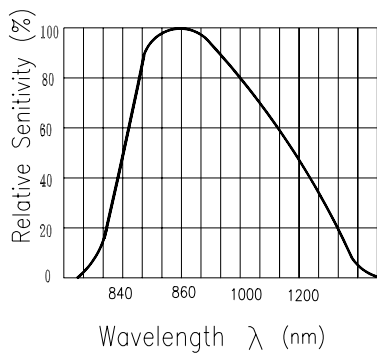
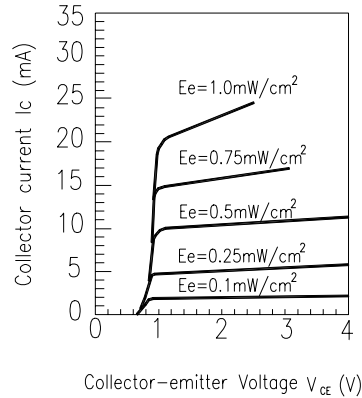

Fig.6 Collector Current vs. Collector-emitter Voltage



Typical Electrical/Optical/Characteristics Curves for ITR

Fig.7 Relative Collector Current vs. Distance between Sensor and Al Evaporation Galss

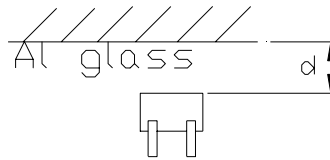
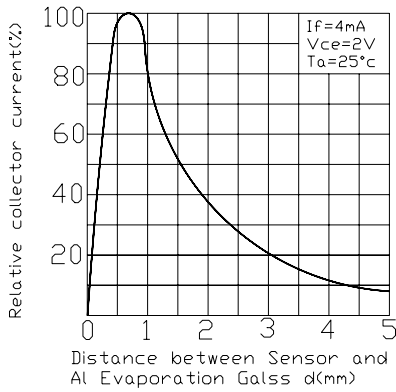

Fig.8 Relative Collector Current vs. Card Moving Distance (l)

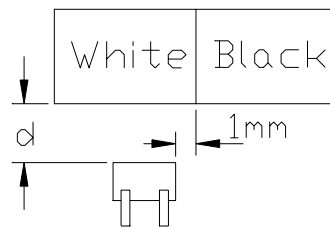
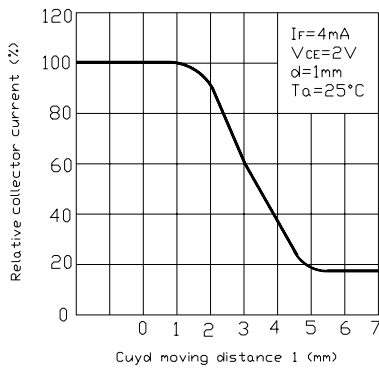
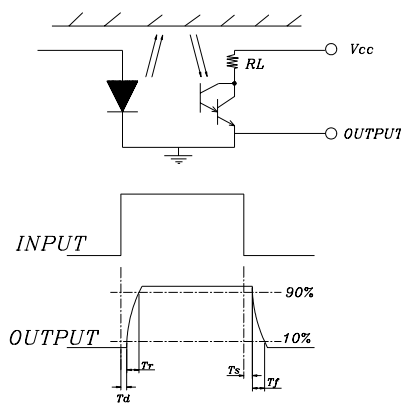
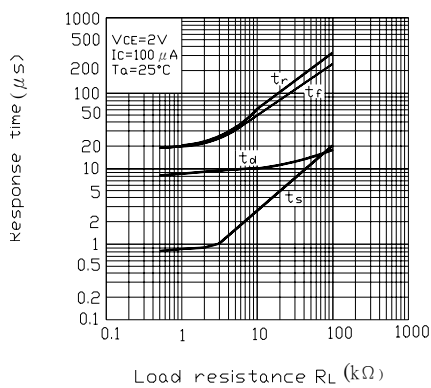

Fig.9 Response Time vs. Load Resistance



Reliability Test Item And Condition

The reliability of products shall be satisfied with items listed below.

Confidence level : 90%

LTPD : 10%

NO.	Item	Test Conditions	Test Hours/ Cycles	Sample Sizes	Failure Judgement Criteria	Ac/Re
1	Solder Heat	TEMP. : 260°C±5°C	10secs	22pcs		0/1
2	Temperature Cycle	H : +85°C 30mins ↑ 5mins ↓ L : -55°C 30mins	50Cycles	22pcs	$I_R \geq U \times 2$ $E_e \leq L \times 0.8$ $V_F \geq U \times 1.2$	0/1
3	Thermal Shock	H : +100°C 5mins ↑ 10secs ↓ L : -10°C 5mins	50Cycles	22pcs	U : Upper Specification	0/1
4	High Temperature Storage	TEMP. : +100°C	1000hrs	22pcs	Limit L : Lower	0/1
5	Low Temperature Storage	TEMP. : -55°C	1000hrs	22pcs	Specification Limit	0/1
6	DC Operating Life	$I_F = 20mA$	1000hrs	22pcs		0/1
7	High Temperature/ High Humidity	85°C / 85% R.H	1000hrs	22pcs		0/1

■ Packing Specifications

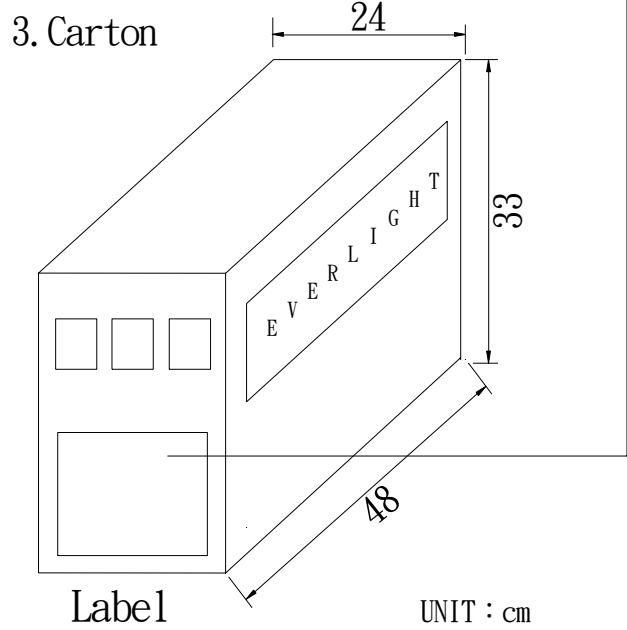
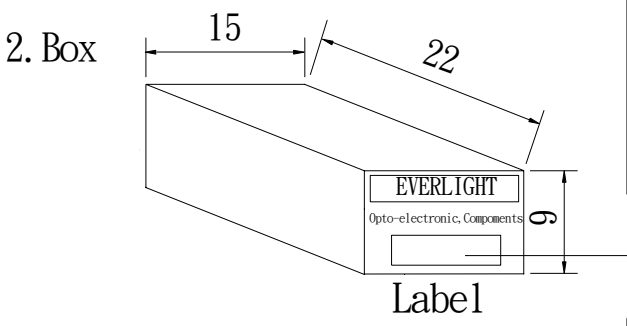
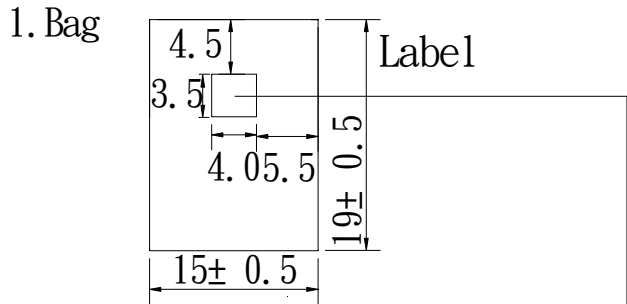

EVERLIGHT

CPN:
P/N:
ITR8307/L24/F43
QTY:
LOT NO:

CAT:
HUE:
REF:

MADE IN TAIWAN

CPN : Customer's Production Number
P/N : Production Number
QTY : Packing Quantity
CAT : Ranks
HUE : Peak Wavelength
REF : Reference
LOT NO : Lot Number
MADE IN TAIWAN : Production place

■ Packing Quantity

- 1. 1000Pcs/1Bag
- 2. 1Bag/1Carton

Recommended Method of Storage

The following are general recommendations for moisture sensitive level (MSL) 4 storage and use:

- Shelf life in sealed bag: 12 months at < 40 °C and < 90% relative humidity (RH)
- After bag is opened, devices that will be subjected to reflow solder or other high temperature process must
 - a) Mounted within 72 hours of factory conditions < 30 °C/60%RH, or
 - b) Stored at <20% RH
 - Devices require bake, before mounting, if:
Humidity Indicator Card is > 20% when read at 23 ± 5 °C
- If baking is required, devices may be baked:
 - a) 192 hours at 40°C ,and <5% RH(dry air/nitrogen) or
 - b) 96 hours at 60°C ,and <5% RH for all device containers
 - c) 24 hours at 125 °C

EVERLIGHT ELECTRONICS CO., LTD.

Office: No 25, Lane 76, Sec 3, Chung Yang Rd,
Tucheng, Taipei 236, Taiwan, R.O.C

Tel: 886-2-2267-2000, 2267-9936

Fax: 886-2267-6244, 2267-6189, 2267-6306

<http://www.everlight.com>